



international

2023

MOBILIARIO

nowa szkoła



Dear Clients,

For 30 years nowa szkoła has been taking care of children's development by creating a safe space for education. Thanks to our experience, we can cater for the needs of students and teachers in an ever-changing reality.

Our products combine modern design with high standards while the team of experienced designers, trusted suppliers and innovative manufacturing solutions guarantee high quality of our products as well as services. International certificates and compliance of products with regulations attest to our high standards. Inside the catalogue, you will find our usual offer with a special addition of carefully selected novelties for 2023:

FURNITURE including 15 collections: Minty, Fantasy (Forest, Jungle, Farm, Royal, Wave), Pastel & Rainbow, Cubo, Fresh, Prima, Classical, Modern, Exclusive, Train, as well as chairs, tables and desks, cloakrooms, soft seats, equipment for cloakrooms and bathrooms.

REHABILITATION & ACTIVITY PLAY which consist of foam shapes, soft rockers, mattresses, dry pools, sensory aids, gym equipment for active play or rehabilitation.

EDUCATION in the form of teaching aids, which especially teachers of mathematics, geography, biology, chemistry, physics, ICT, arts & crafts will appreciate. In this category, you will also see educational accessories as well as toys promoting the development of the little ones.

We hope that the selection will be a source of inspiration and we will be happy to assist you in building a wide offer for your customers.

nowa szkoła team

nowa szkoła

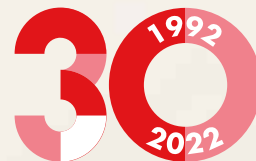



OUR MISSION

Our core mission is to create space for education. With 30 years of experience in the field, we strive to further develop the brand in accordance with the idea of corporate social responsibility. As nowa

szkółą we do our best to follow the latest trends in education in a pro-social and ecological way while keeping children at the heart of everything we do.

OUR VISION

Thanks to our team of committed and qualified employees we are able to respond quickly to the constantly evolving needs of the little ones which arise from the current global situation, new social problems, and technological development.

Our goal is to take responsibility not only for the quality of products and services but also for the environment. We want to become a company known for its quality and a portfolio which cater for a wide range of clientele.



OUR STRATEGY

In everything we do, we always keep the good of children, teachers, care workers and the environment in mind. By planning ahead, and making sure to leave some room for flexibility, we strive to constantly enhance our brand reputation. To guide us in carrying out our mission, we established 3 base points which ensure that we stay true to our rules of conduct and areas of activity.

1

Customer satisfaction

We care about the quality of our products and services as well as punctuality of deliveries. The continuous certification process ensures that all safety standards are met.

2

Cooperation policy and transparency of actions

We believe that teamwork can get us the best results, and it's visible in our well-organised structure. In a spirit of mutual respect, confirmed by the ISO 9001:2015 quality management system certificate, we take into consideration social interest and fair relationship with stakeholders.

3

Ecology

Care for the environment is an integral part of the company's policy. We promote the idea of an ecological attitude by monitoring our energy and water consumption, efficient use of resources, introducing improvements like reusing materials or the use of cardboard packaging – being our hallmark.

EXPERIENCE



SATISFIED CUSTOMERS ON EVERY CONTINENT



We are active on the Polish and international market

- 40 000 clients in Poland
- 200 distributors around the world in nearly 60 countries



INTERNATIONAL CERTIFICATES AND STANDARDS

Each year more and more products undergo a certification process to prove their quality. During this process we have obtained the ISO 9001:2015 quality management system certificate - the audit covered the manufacturing

facility as well as the warehouse in following areas: design, production, storage, and sale.



ISO 9001
LL-C (Certification)



POLISH MANUFACTURING FACILITY WITH MODERN MACHINE PARK AND WAREHOUSE

Thanks to the qualified team and modern machinery we are able to take on varied and ambitious projects. Our recently built A+ high storage warehouse was designed in

accordance with the principles of sustainable development which is confirmed by BREEAM certification.



CREATIVE DESIGNERS

Our team of highly qualified people with open minds is continuously working on new designs. User-friendly functionality is of utmost importance to us.



WIDE SELECTION

Every year we make our product selection richer and more diverse to cater for individual needs of clients. Everyone can find something for themselves, from nurseries, kindergartens, primary or secondary schools, children with special educational needs to seniors.

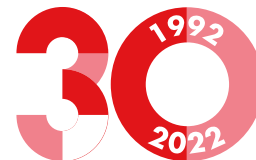

years of experience on the education market

Based in Poland, we are a Polish company and a leader in the Polish and global educational market. As a company with more than 30 years of experience, we equally care about the product safety, quality and comfort of children and teachers.



COOPERATION WITH SPECIALISTS

Every project is consulted with quality work specialists as well as teachers and methodologists who work with children on a daily basis – children are our main, and at the same time the most demanding and uncompromising, customers.



RELIABLE SUPPLIERS

During our presence on the education market for more than 30 years, we have built strong and lasting relationships with over 500 key, responsible suppliers.

THEN & NOW



ESTABLISHMENT
OF THE COMPANY

1992



OUR FIRST LOGO



OUR CURRENT LOGO



OPENING OF THE
MANUFACTURING
FACILITY

2002



OUR FIRST
POLISH CATALOGUE



OUR CURRENT
POLISH CATALOGUE



OUR FIRST
FURNITURE
COLLECTION

OUR LATEST
FURNITURE
COLLECTION





OFFICE



CARPENTRY SHOP



SEWING ROOM



30TH ANNIVERSARY OF THE COMPANY

2022



WAREHOUSE



SERVICE



CERTIFICATES & STANDARDS



To make sure that our products meet all the safety standards we cooperate with a reputable company like the Technical Supervision Institute (Instytut Nadzoru Technicznego Sp. z o.o. (INT)), which is an accredited provider of testing and certification services for industries active in the areas of sports, furniture, education, and architecture. Credibility, impartiality, and reliability of the Institute is ensured by the Polish Centre for Accreditation. All certificates issued by the Technical Supervision Institute are recognized throughout the European Union in accordance with EU Regulation No. 765/2008. Additionally, the accreditation no. AC 171 for product

certification body allows the Technical Supervision Institute to provide certifications for sports equipment, furniture and equipment for playgrounds and games. The company also offers services in product certification, technical inspection, and acceptance. The focus on high-quality and professionalism allows the company to build lasting connections with leading producers, distributors, and importers from various industries. The authenticity as well as the validity of certificates can be confirmed in a special search engine:

www.Instytut-nadzoru.com

The fact that nowa szkoła has been certified by the Technical Supervision Institute guarantees safety and ensure that all our products meet the required norms and quality standards.



The international ISO 9001:2015 norm defines the requirements for the quality management system.

nowa szkoła has met these requirements ISO 9001:2015

in order to conduct business in the fields of design, production, storage and sale of furniture as well as equipment for educational facilities, and on 9th July 2021 has obtained the ISO 9001:2015 certificate. The certified departments include design, production, storage, and sale. This certificate allows nowa szkoła to consistently deliver products and services conforming to its clients needs, and collaborate with Polish and international companies or institutions, while at the same time meeting all legal and regulatory requirements.



OUR PRODUCTS MEET THE FOLLOWING STANDARDS APPLICABLE IN POLAND AND THE EUROPEAN UNION

FURNITURE COLLECTIONS: PN-EN 16121, PN-EN 14749

CHAIRS, TABLES AND DESKS: PN-EN 1729-1, 2

HIGH CHAIRS: PN-EN 14988

BLACKBOARDS: PN-EN 14434

CARPETS: EN 71, REACH

SOFT PLAY AND MATTRESSES: EN 71, EN 913, REACH

REHABILITATION AIDS: EN 71, EN 913

OUTDOOR PLAYGROUNDS: EN 1176

GYM EQUIPMENT: EN 913

TOYS: EN 71 1, 2, 3 and REACH



MATERIALS WE USE

LAMINATED CHIPBOARD

MELAMINE OR HPL LAMINATE (thk. 18 mm, 25 mm)

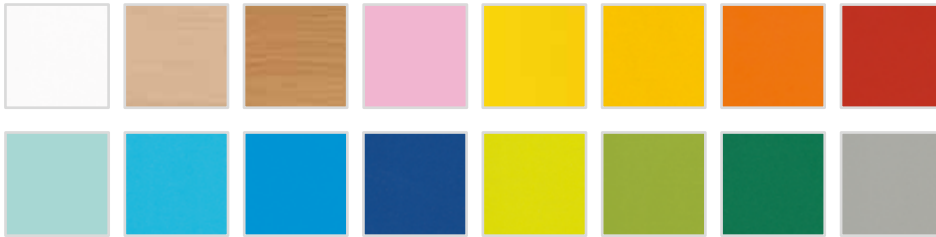

scale 1 : 1



scale 1 : 1



LAMINATED FLAME RETARDANT CHIPBOARD (thk. 18 mm)



LAMINATED MDF BOARD (thk. 6 mm, 12 mm)

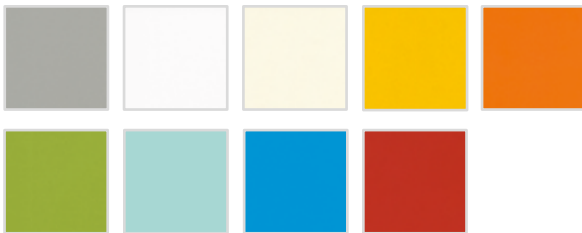

scale 1 : 1



scale 1 : 1



PLYWOOD AND LAMINATED PLYWOOD



HDF BOARD (3,2 mm)



scale 1 : 1



EGDE BANDING Available in all colours of MDF boards and chipboards.



FABRICS

OXFORD



PVC

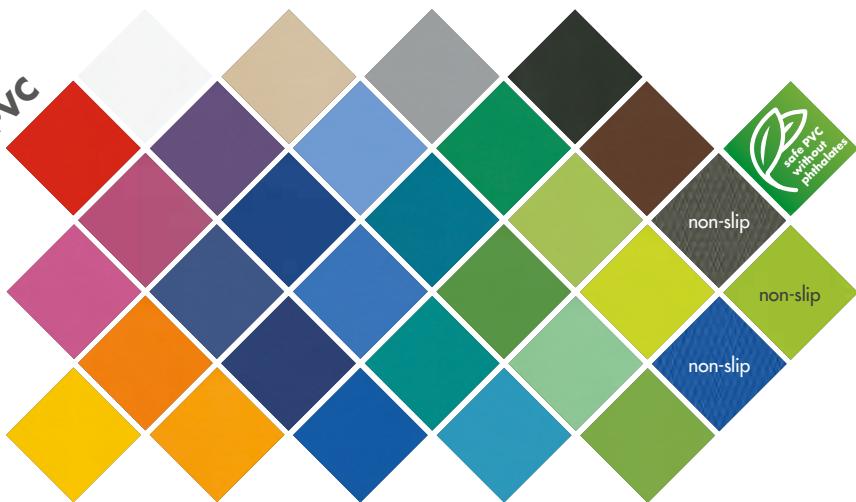

DENIM



VELOUR



FILLINGS

1. POLYURETHANE FOAM
2. SHREDDED FOAM
3. POLYSTYRENE GRANULATE
4. WADDING

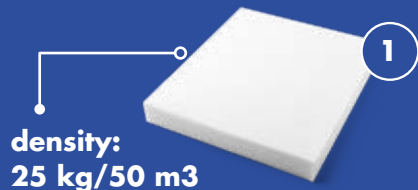

OUR PROJECTS

NURSERY



KINDERGARTEN



PRIMARY AND SECONDARY SCHOOL



**SENSORY
INTEGRATION ROOM**

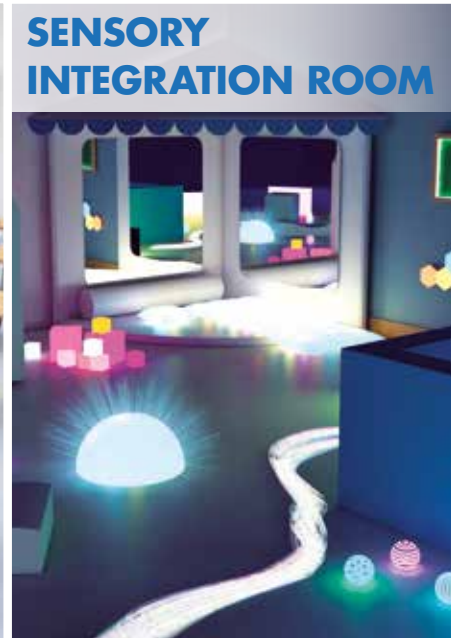

THERAPY ROOM



HEADMASTER'S OFFICE



DAY CARE CENTRE



CLOAKROOM



CANTEEN



SCIENCE AND TECHNOLOGY CLASSROOM



FURNITURE

COLLECTIONS	16
LIBRARY	196
DISPLAY UNITS.	210
MULTIFUNCTION CABINETS.	212
MANIPULATIVE CORNERS	228
ROLE PLAY.	231
TABLES	234
SCHOOL DESKS	254
CHAIRS.	266
DESKS.	280
CLOAKROOMS.	294
BEDROOM.	312
BATHROOM.	322
DINING ROOM AND KITCHEN.	334
SAFETY.	338
WALL BOARDS & DISPLAY	342
MEDICAL'S OFFICE	347
SOFT SEATS	348
CARPETS.	386

REHABILITATION & ACTIVITY PLAY

REHAB SOFR PLAY BLOCKS	392
BALL POOLS	432
SENSORIAL INTEGRATION	436
SPORT EQUIPMENTS.	510

ICONS



Printed



Magnetic



NS design



new colours /
product update



Novelty



Washable

EDUCATION

MOTOR SKILLS.	546
DALTON PLAN	604
MONTESSORI EDUCATION.	605
EMOTIONS	621
ENGLISH	626
MATH AIDS	637
GEOGRAPHY AIDS	670
BIOLOGICAL AIDS.	682
CHEMICAL AIDS.	709
PHYSICAL AIDS	714
ICT	730
ART & CRAFT	746
THEATRE.	784
MUSIC.	796
TOYS.	810
ROLE PLAY.	866







Minty is a collection in light pastel colours which combines functionality with aesthetic appeal. Its diverse modules have been specifically designed to meet the demands of the young, their daily rhythm and habits. The set consists of open and closed cabinets, storage cabinet for beds and linen and soft seats on castors. A unique element is a playhouse with a soft moulded floor - a safe hideaway and place for play. The set also includes

a minder's desk, which harmonizes with the whole series, and a large carpet with animal motifs (the same as on the cabinets)

- colour: neutral light green
- storage for beds and linen
- hideaway playhouse with roof and foam floor
- 6 versions of cabinets - doors with animal motifs
- cabinet with 4 foam pouffes
- cabinet with castored chests (frogs)
- desk with lockable door for minder
- chest set Caterpillar
- corner cabinets
- changing table

TECHNICAL SPECIFICATION

BODY:

board: chipboard

colour: birch



thickness: 18 mm

base: board

SHELVES:

board: chipboard

thickness: 18 mm

colour: birch



height adjustment: yes

DOORS:

type: opened

board: MDF

surface: milled

colour: white



thickness: 12 mm

type of handle:
aluminium

ADD-ONS:

board: MDF

surface: milled

thickness: 12 mm

colour: light green



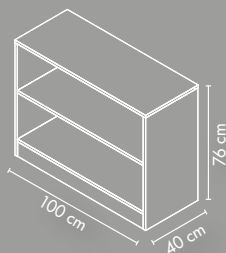
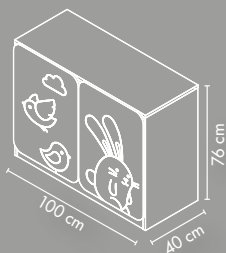
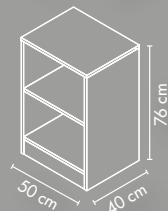
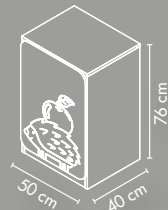
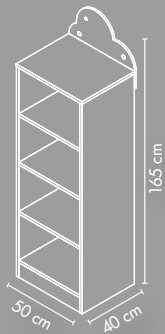
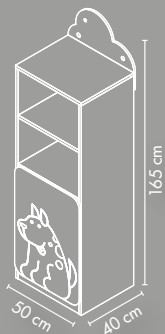
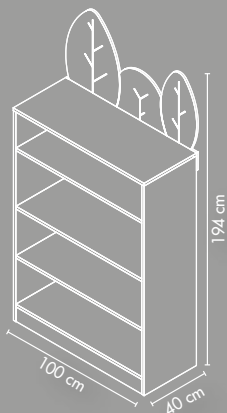
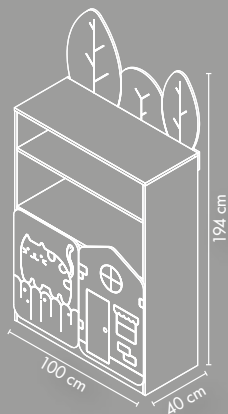

MINTY FURNITURE

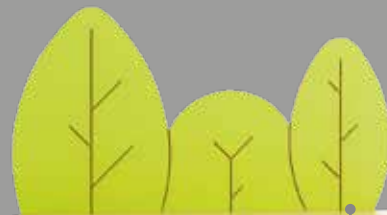

FEATURES



hideaway playhouse
with PVC element



funny millings

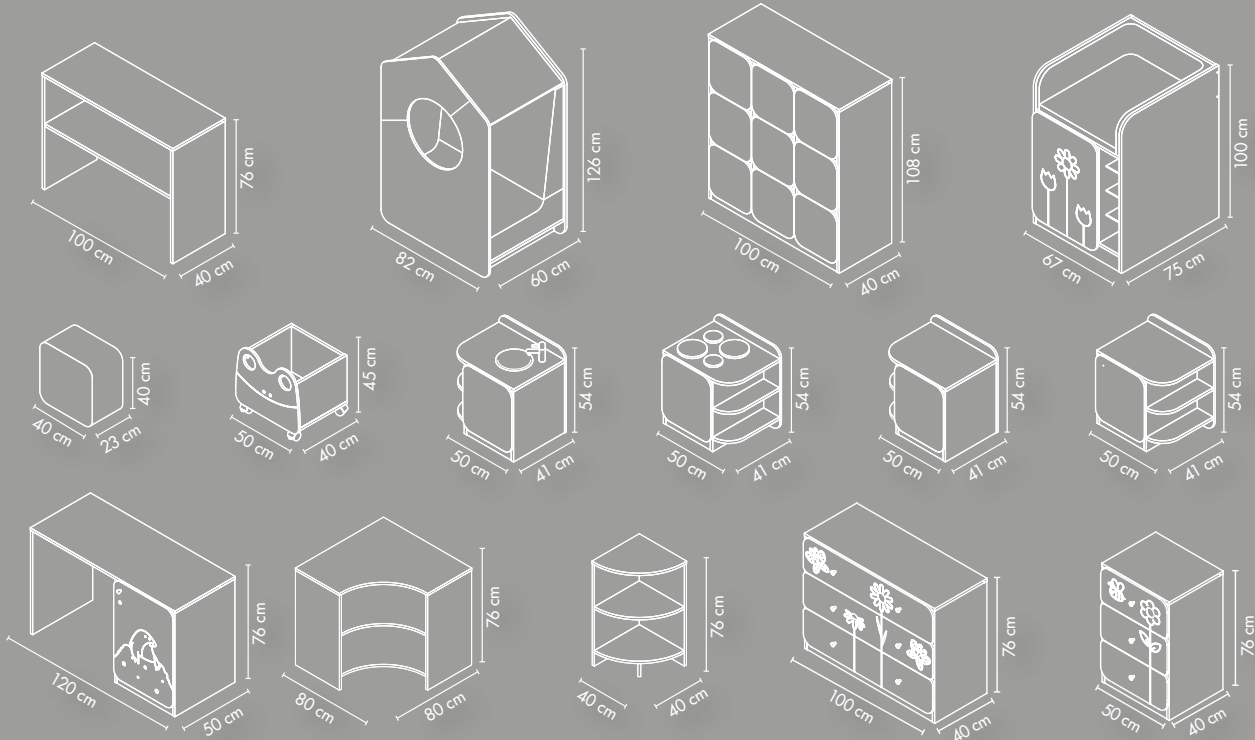

STORAGE



**Cabinet
NS3222**

- dim.: 100 x 40 x 76 cm



**Cabinet
NS3223**

- dim.: 50 x 40 x 76 cm



**Cabinet with 2 doors
NS3202**

- dim.: 100 x 40 x 76 cm



**Cabinet with doors
NS3201**

- dim.: 50 x 40 x 76 cm



**Tall unit
NS3221**

- dim.: 100 x 40 x 140 cm



**Tall unit
NS3220**

- dim.: 50 x 40 x 140 cm



**Tall unit with 2 doors
NS3206**

- dim.: 100 x 40 x 140 cm



**Tall unit with doors
NS3205**

- dim.: 50 x 40 x 140 cm



- 6 storages:
30 x 37 x 31 cm;
- 3 storages:
30 x 37 x 26 cm

**Cabinet
NS3224**

- dim.: 100 x 40 x 108 cm





**Minty. Narrow chest of 3 drawers
NS3231**

- dim.: 50 x 41 x 77 cm



**Minty. Wide chest of 3 drawers
NS3232**

- dim.: 100 x 41 x 77 cm
- each drawer with compartment



**Pouf set
NS3214**

- 4 pcs, dim.: 40 x 40 x 23 cm

**Cabinet
NS3200**

- dim.: 100 x 40 x 76 cm

**Chest Frog
NS3211**

- 1 pc, dim.: 50 x 40 x 45 cm

**Chests Frogs
NS3212**

- 2 pcs, dim.: 50 x 40 x 45 cm

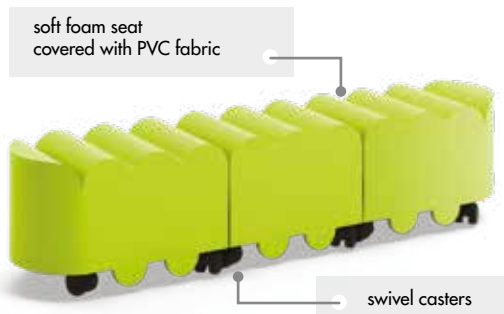

**Chest set Caterpillar
NS3213**

- 3 pcs, dim.: 36 x 30 x 30 cm



**Corner unit
NS3204**

- dim.: 80 x 80 x 76 cm



**Inside Corner unit
NS3203**

- dim.: 40 x 40 x 76 cm

HIDING HOUSE

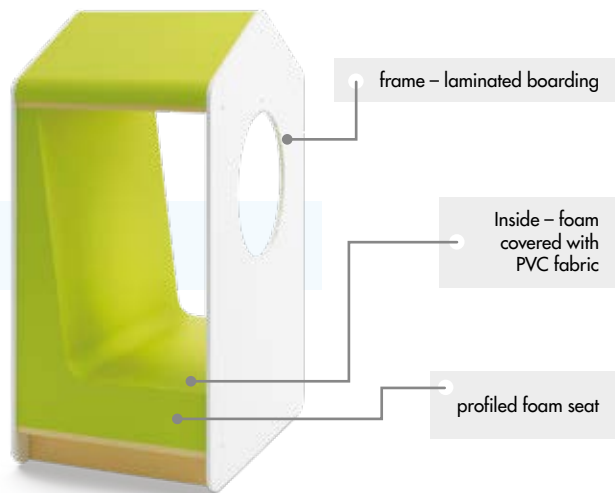

**Hideaway playhouse
NS3210**

• dim.: 82 x 60 x 126 cm



CHANGING UNIT



**Changing unit
NS3207**

• dim.: 67 x 75 x 100 cm



STORAGE FOR BEDS AND LINEN



Storage for beds and linen
NS3208

- dim.: 141 x 60 x 200 cm

DESK

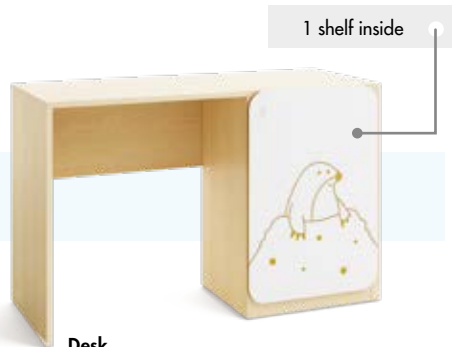

Desk
NS3209

- dim.: 120 x 50 x 76 cm



KITCHEN ISLAND



A set of wooden furniture which imitates kitchen equipment. The overprints on the doors add a realistic look. The set includes a fridge, washing machine, stove, sink. Each door has a different picture.

The furniture can be used in various configurations: an island in the middle of the room, a row at a wall or as separate pieces in different parts of the room.

- dim. each one: 50 cm x 41 cm x 54 cm



Kitchen Island NS3219

- fridge: 50 x 41 x 54 cm;
- washing machine: 50 x 41 x 54 cm;
- sink: 50 x 41 x 54 cm;
- oven: 50 x 41 x 54 cm



Oven NS3215

- dim.: 50 x 41 x 54 cm



Washing Machine NS3216

- dim.: 50 x 41 x 54 cm



Sink NS3217

- dim.: 50 x 41 x 54 cm



Fridge NS3218

- dim.: 50 x 41 x 54 cm

DECORATIVE BOARDS

- MDF milled



Shrub wall decoration
NS3237

- dim.: 98 x 55 cm



Lily of the valley wall decoration
NS3239

- dim.: 39,5 x 119 cm

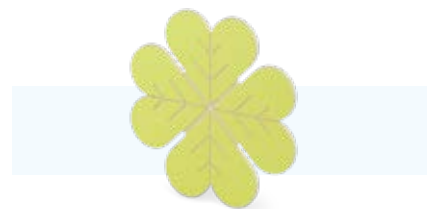

Clover wall decoration
NS3238

- dim.: 45 x 45 cm





CARPET

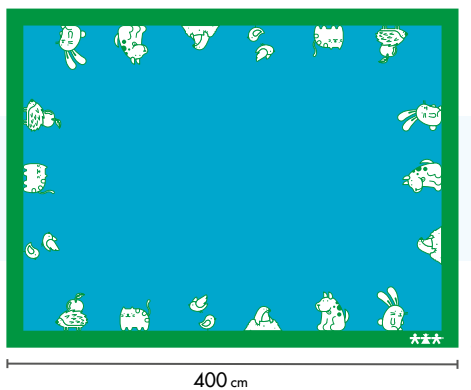

Carpet Minty
HK0009

- polyamide with latex bottom

SETS



MINTY SET 1

NS3250

Minty furniture set which consists of the following pieces: NS3232, NS3205, NS3221, NS3201, NS3223, NS3203.

- total length of the set: 390 cm; depth: 41,2 cm;
- height ranging from 76 cm to 194 cm with decorations



MINTY SET 2

NS3251

Minty furniture set which consists of the following pieces: NS3231, NS3220, NS3206, NS3205, NS3202, NS3222, NS3203.

- total length of the set: 490 cm, depth: 41,2 cm;
- height ranging from 76 cm to 194 cm



Fantasy

Jungle

Wave

Royal

Farm

Forest

The series consists of five collections: Farm, Wave, Royal Jungle and Forest. Being module-based, they offer freedom of arrangement. Each set consists of the same modules - they only differ in the decorative back boards and front doors. The furniture is sold - as separate unit or as a set - together with doors and decorative back boards.

BODY:

board: chipboard
colour: birch



thickness: 18 mm
base: board

APPLICATIONS:

board: MDF
surface: UV print / milling
thickness: 12 mm
colours:



The series consists of:

- chest cabinet
- cabinet with door and one shelf
- cabinet with door and 2 shelves
- two tall cabinets of different heights
- cabinet with two doors and two shelves
- cabinet without door (with two shelves)
- cabinet with sliding door
- cabinet with 9 cubby holes
- printed elements

SHELVES:

board: chipboard
thickness: 18 mm
colour: birch



DOORS:

type: opened / slide
board: MDF
surface: smooth / milling / UV print
colours:



thickness: 12 mm
type of handle: cutout

NORMS AND CERTIFICATES:

INTCERT
PN-EN 14749:2016-04

FANTASY FURNITURE

This series of children's furniture makes the arrangement of nurseries and kindergartens more vivid and interesting. Each of the five collections catches the eye with original colours and fairy tale-inspired applications. Open shelves, storage units and cabinets provide space for storing books, toys and teaching aids. The characteristic modular frame is mounted on stable legs. It also makes cleaning trouble-free - you can

conveniently vacuum or wash hard-to-reach places under furniture. Plastic legs are resistant to cleaning agents and they don't absorb water. The furniture is made of high-quality materials which are easy to clean and disinfect. Units exist as well on the green plinth.

WITH LEGS

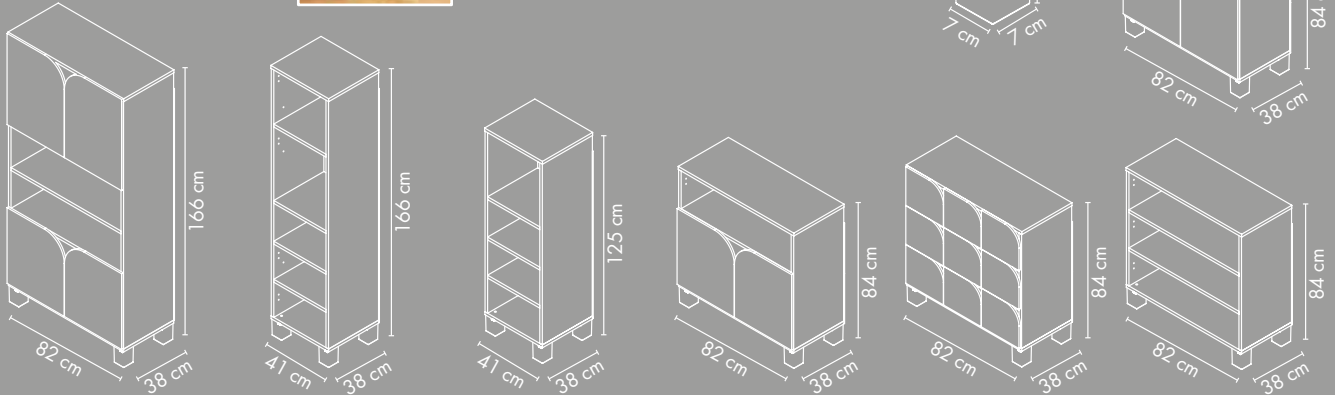

ON A PLINTH



DESK

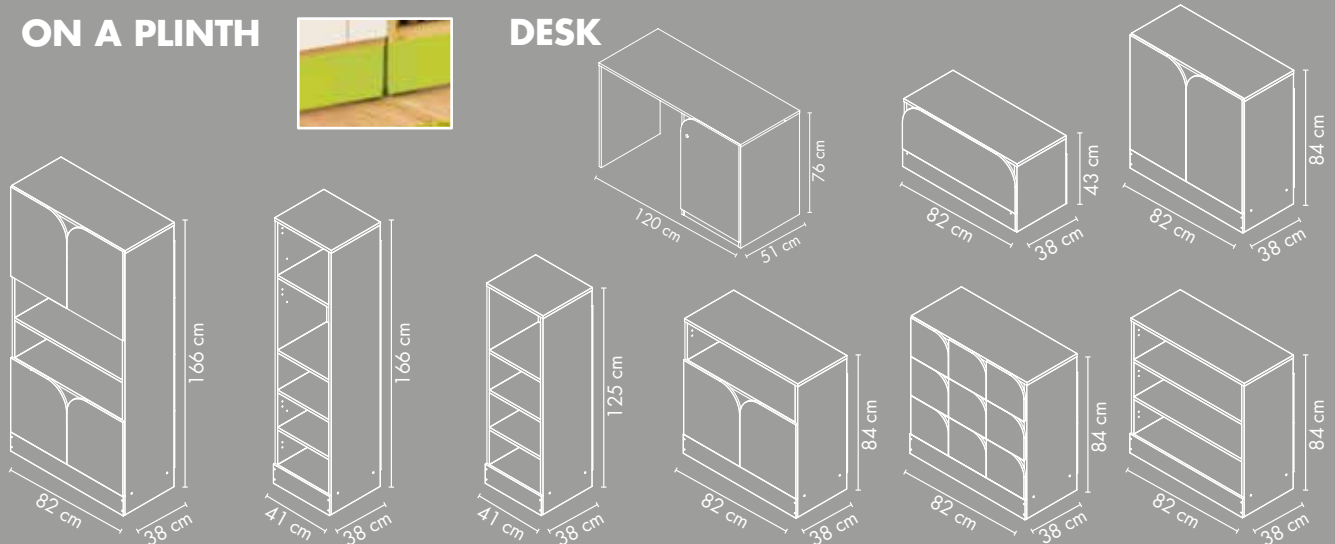

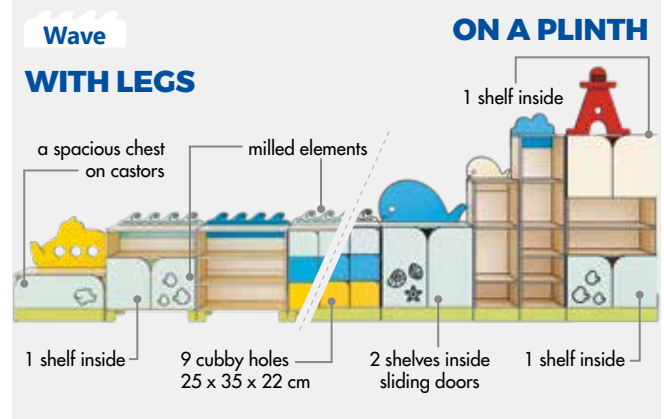
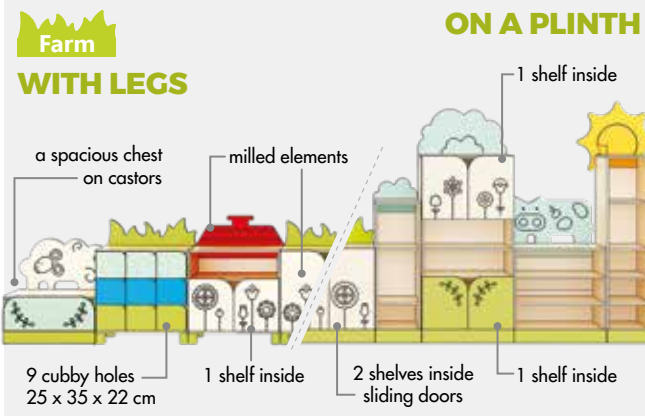
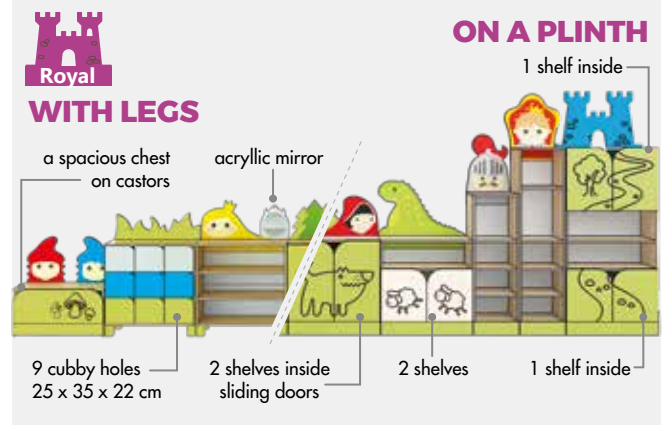
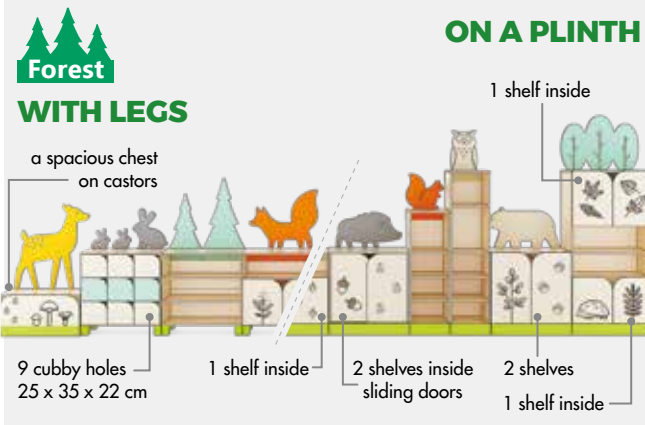



Forest

Children love animals and they like to watch and play with them. To meet their needs, we present a new, Forest collection of Fantasy line. The whole line consists of the same furniture modules differing only by decorations and prints on the fronts. The Forest line has been additionally enriched with the teacher's desk. The furniture is perfect for furnishing nurseries and kindergarten rooms; they

create a functional space and help to organise the children's activities. The wide selection of modules allows you to freely arrange the interiors to make them suitable for the little ones. Their universal colour palette acts as a background for different elements and decorations. All furniture pieces can be purchased in a set or separately and with plastic legs or on a plinth.





**Deer container
on a plinth** **NS2588**

- dim.: 82 x 38 x 43,3 cm;
- with 147,9 cm high decoration



**Fir trees cabinet
with legs
on a plinth** **NS2584**

- dim.: 82 x 36,8 x 83,6 cm;
- with a decoration: 120,8 cm high



**Fox cabinet
with legs
on a plinth** **NS2589**

- dim.: 82 x 38 x 83,6 cm



**Cabinet with sliding doors
with legs
on a plinth** **NS2585**

- dim.: 82 x 36,8 x 83,6 cm;
- with a decoration: 127 cm high



**Bear cabinet
with legs
on a plinth** **NS2580**

- dim.: 82 x 38 x 84,3 cm;
- with a decoration: 161,6 cm high

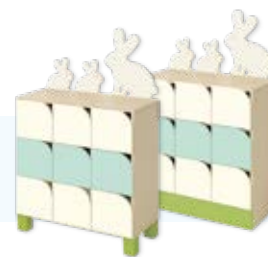

**Cabinet with compartments
with legs
on a plinth** **NS2586**

- dim.: 82 x 38 x 83,6 cm;
- with a decoration: 132,9 cm high



**Small squirrel cabinet
with legs
on a plinth** **NS2581**

- dim.: 41 x 36,8 x 124,5 cm;
- with a decoration: 223,1 cm high



**Owl cabinet
with legs
on a plinth** **NS2583**

- dim.: 41 x 36,8 x 165,5 cm



**Trees cabinet
with legs
on a plinth** **NS2582**

- dim.: 82 x 36,8 x 165,5 cm;
- with a decoration: 207,8 cm high



492 cm

Forest. Set 1
NS2590

total length 492 cm

- NS2582
- NS2581
- NS2589
- NS2588
- NS2585
- NS2584
- NS2583



369 cm

Forest. Set 2
NS2591

total length 369 cm

- NS2589
- NS2588
- NS2585
- NS2584
- NS2583



287 cm

Forest. Set 3
NS2592

total length 287 cm

- NS2588
- NS2585
- NS2584
- NS2583



DESK

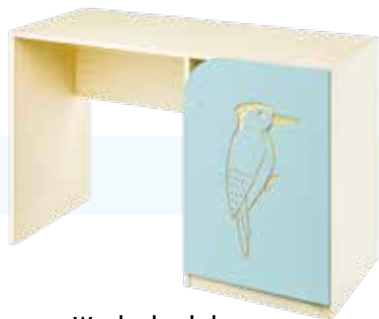

Woodpecker desk
NS2587

- dim.: 120 x 51,2 x 76,5 cm

SHELVES



Hedgehog. Wall shelf
NS2593

- dim.: 41 x 16 cm



FLAT CUSHIONS



Nature.
Sitting foam cushions in a bag
NS2237

- ø 34, H 2 cm, with the non-slip PVC cover in white and grey colour; filled with polyurethane foam; the set consists of 10 pieces with prints; weight: 1,3 kg; inspired by nature sitting discs made of foam covered with phthalate-free PVC fabric; the trimming is made of reinforced cotton tape ribbon; storage: a bag made of oxford fabric in cornflower colour; closed with a string with a plastic stopper



CARPETS



Forest.
Fantasy polyamide carpet
MU0005

Big carpet "Forest" perfect for nurseries and kindergartens. This product will complement any interior as well as create space for relaxation or playtime. The fabric is resistant to abrasion. It also has anti-microbial and anti-mould properties. The carpet is easy to clean.

- colours do not fade; fabric: polyamide yarn; dim.: 400 x 300 cm

MANIPULATIVE BOARDS



Forest. Manipulative board
NS9090

- manipulation board, forest themed;

- it is equipped with 3 movable elements, 4 elements with texture and 1 rotating element;
- the board is made of MDF board with a UV print;
- dim.: 130 x 79 cm



Manipulative-sensory wall
NS9078

A wall panel with manipulative and sensory activities for play and practising hand-eye coordination. Equipped with safe elements with which a child will explore the world

using all the senses. Panels with rounded edging are sold separately and include: animals with textures, moveable figures and a pirates wheel.

- 1 panel dim.: 130 x 95 cm;
- material: wood, MDF board; age: 3+

Jungle

Yes an exotic trip to the savanna and meet the happy friends from the latest Jungle series. The nine funny animals come from steppes, rivers and rain forests. The warm pastel blues and greens will bring a joyful atmosphere to any interior. The additional desk and poufs follow the design to maintain a consistent look.



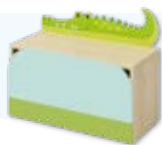

**Storage unit Crocodile
on a plinth NS2811**

- dim.: 82 x 38 x 43 cm



**Shelving unit Lion
with legs FN2817
on a plinth NS2817**

- dim.: 82 x 38 x 43 cm



**Storage unit Hippo
with legs FN2812
on a plinth NS2812**

- dim.: 82 x 38 x 43 cm



**Storage unit Elephant
with legs FN2813
on a plinth NS2813**

- dim.: 82 cm x 38 cm x 84 cm



**Storage unit with sliding doors
with legs FN2818
on a plinth NS2818**

- dim.: 82 x 37 x 126,5 cm;
- with a decoration: 161,6 cm high



**Locker unit Zebra
with legs FN2819
on a plinth NS2819**

- dim.: 82 x 38 x 84 cm;
- 9 lockers, 22 x 25 cm



**Shelving unit Toucan
with legs FN2814
on a plinth NS2814**

- dim.: 41 cm x 38 cm x 125 cm



**Shelving unit Giraffe
with legs FN2816
on a plinth NS2816**

- dim.: 41 cm x 38 cm x 166 cm



**Storage unit Baobab
with legs FN2815
on a plinth NS2815**

- dim.: 82 cm x 38 cm x 166 cm

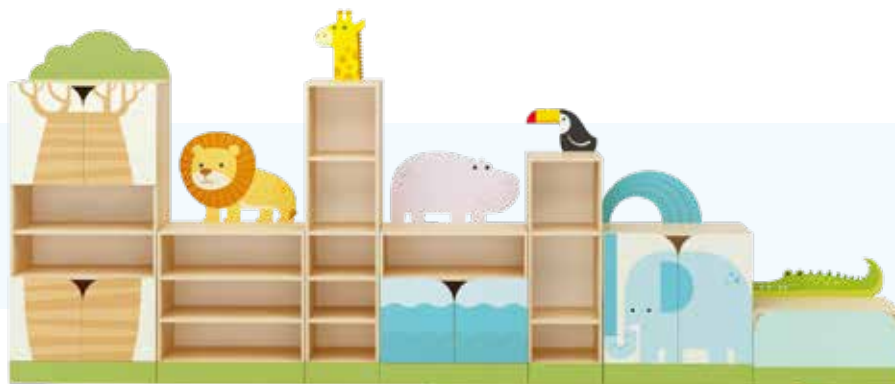

492 cm

Jungle. Set 1
NS2800

total length 492 cm

- NS2815
- NS2817
- NS2816
- NS2812
- NS2814
- NS2813
- NS2811



369 cm

Jungle. Set 2
NS2801

total length 369 cm

- NS2816
- NS2817
- NS2812
- NS2813
- NS2811



287 cm

Jungle. Set 3
NS2802

total length 287 cm

- NS2816
- NS2817
- NS2813
- NS2811



DESK



Flamingo Desk
NS2820

- dim.: 120 x 52 x 76 cm

SHELVES



Gorilla. Wall shelf
NS2810

- dim.: 41,2 x 16,2 cm

FLAT CUSHIONS



Jungle seats
NS2830

8 seats with different printed animals

- PVC cover;
- fit the container on casters;
- ø 34 H 3 cm



CARPETS



**Carpet Jungle
DL0500**

A carpet made from a double frise polypropylene yarn. These carpets are soft, antiallergic, anti-static, fade and wear resistant, easy to clean and with a non-slip bottom.

- dim.: 4 x 5 m; heat set frise carpet



MANIPULATIVE BOARDS



**Jungle Sensory Board
NS0893**

A board with sensory elements: a monkey with a fluffy tummy, a lion with a mane, elephant's skin, tree bark, grainy soil.

- dim.: 119 x 76,5 cm



**Manipulative sensory wall
NS9077**

A wall panel with manipulative and sensory activities for play and practising hand-eye coordination. Equipped with safe elements with which a child will explore the world using all the senses.

- panels with rounded edging are sold separately and include: animals with textures, moveable figures and a pirates wheel;
- 1 panel, dim.: 130 x 79 cm; material: wood, MDF board; age 3+

Farm

Welcome on the old Donald's farm. The collection is inspired by green meadows. When it's rainy and windy outside, have fun on the ever-sunny farm.





**Storage unit Lamb
on a plinth** **NS1868**

- dim.: 82 x 38 x 43 cm

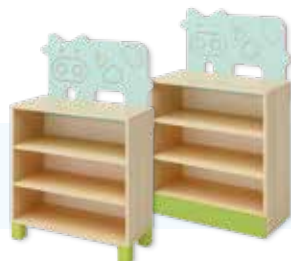

**Shelving unit Cow
with legs
on a plinth** **NS1874**

- dim.: 82 x 38 x 84 cm;



**Storage unit House
with legs
on a plinth** **NS1869**

- dim.: 82 x 38 x 84 cm



**Storage unit Grass
with legs
on a plinth** **FN1870**
NS1870

- dim.: 82 cm x 38 cm x 84 cm



**Storage unit with sliding doors
with legs
on a plinth** **FN1875**
NS2855

- dim.: 82 x 37 x 111 cm

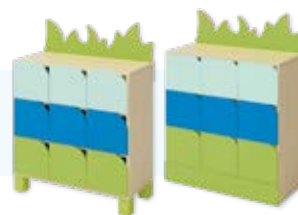

**Locker unit
with legs
on a plinth** **FN1876**
NS2856

- dim.: 82 x 38 x 84 cm;
- 9 lockers, 22 x 25 cm



**Shelving unit Cloud
with legs
on a plinth** **FN1871**
NS1871

- dim.: 41 cm x 38 cm x 125 cm



**Shelving unit Sun
with legs
on a plinth** **FN1873**
NS1873

- dim.: 41 cm x 38 cm x 166 cm



**Storage unit Cloud
with legs
on a plinth** **FN1872**
NS1872

- dim.: 82 cm x 38 cm x 166 cm

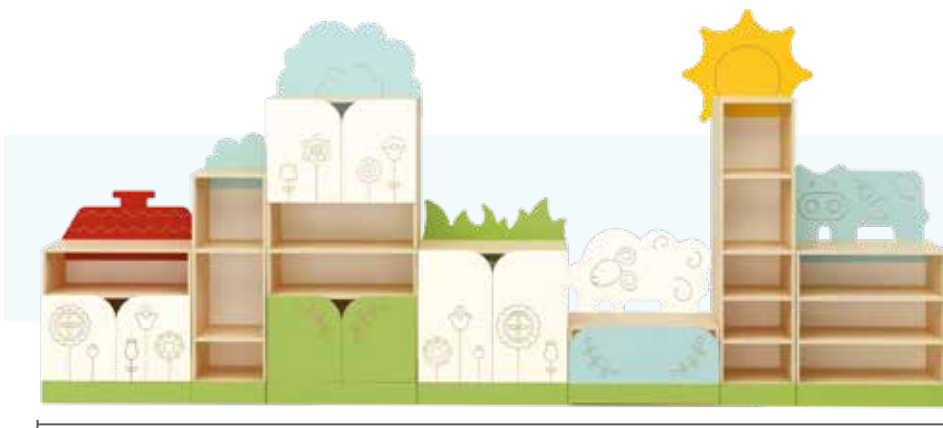

492 cm

Farm. Set 1
NS1865

total length 492 cm

- NS1868
- NS1869
- NS1870
- NS1871
- NS1872
- NS1873
- NS1874



369 cm

Farm. Set 2
NS1866

total length 369 cm

- NS1868
- NS1869
- NS1870
- NS1873
- NS1874



287 cm

Farm. Set 3
NS1867

total length 287 cm

- NS1868
- NS1870
- NS1873
- NS1874

DESKS



**Goose desk
NS2860**

- dim.: 120 x 51 x 77 cm

SHELVES



**Tractor. Wall shelf
NS2859**

- dim.: 41 x 16 cm

CARPETS



**Farm. Fantasy polyamide carpet
MU0002**

Big carpet "Farm" perfect for nurseries and kindergartens. This product will complement any interior as well as create space for relaxation or

playtime. The fabric is resistant to abrasion. It also has anti-microbial and anti-mould properties. The carpet is easy to clean.

- colours do not fade;
- fabric: polyamide yarn;
- dim.: 400 x 300 cm

MANIPULATIVE BOARDS



**Farm. Manipulative board
NS9068**

- the board is made of MDF board with a print;
- it is equipped with 2 movable elements, 3 elements with texture and 1 rotating element;
- dim.: 130 x 79 cm





A fairytale collection inspired by children's literature classics. Let your games be guarded by dwarfs, look into the princess's mirror, set out for Camelot Castle or help the Red Riding Hood by locking the Wolf in a cabinet.





**Storage unit Sprites
on a plinth** **NS2888**

- dim.: 82 x 38 x 43 cm



**Shelving unit Princess
with legs** **FN2894**
on a plinth **NS2894**

- dim.: 82 x 38 x 84 cm



**Storage unit Dragon
with legs** **FN2889**
on a plinth **NS2889**

- dim.: 82 x 38 x 84 cm



**Little Red Riding Hood
with legs** **FN2890**
on a plinth **NS2890**

- dim.: 82 cm x 38 cm x 84 cm

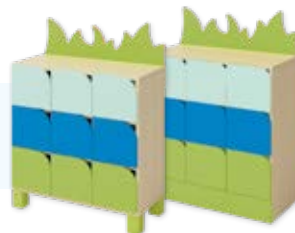

**Locker unit Farm
with legs** **FN1876**
on a plinth **NS2856**

- dim.: 82 x 37 x 111 cm

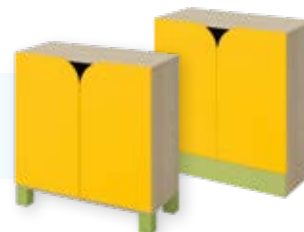

**Storage unit for potties
with legs** **FN1843**
on a plinth **NS1843**

- dim.: 82 x 38 x 84 cm;
- storage space for 9 pots



**Shelving unit Knight
with legs** **FN2892**
on a plinth **NS2892**

- dim.: 41 cm x 38 cm x 125 cm



**Shelving unit Prince
with legs** **FN2893**
on a plinth **NS2893**

- dim.: 41 cm x 38 cm x 166 cm



**Storage unit Castle
with legs** **FN2891**
on a plinth **NS2891**

- dim.: 82 cm x 38 cm x 166 cm



492 cm

Royal. Set 1
NS2885

total length 492 cm

- NS2888 • NS2891, • NS2894
- NS2889 • NS2892
- NS2890 • NS2893



369 cm

Royal. Set 2
NS2886

total length 369 cm

- NS2888 • NS2893
- NS2889 • NS2894
- NS2890



287 cm

Royal. Set 3
NS2887

total length 287 cm

- NS2888 • NS2893
- NS2890 • NS2894

DESKS



**Unicorn desk
NS2880**

- dim.: 120 x 51 x 77 cm

SHELVES



**Castle. Wall shelf
NS2884**

- dim.: 44 x 16 cm

CARPETS



**Royal. Fantasy polyamide carpet
MU0004**

Big carpet "Royal" perfect for nurseries and kindergartens. This product will complement any interior as well as create space for relaxation or playtime.

The fabric is resistant to abrasion. It also has anti-microbial and anti-mould properties. The carpet is easy to clean.

- colours do not fade;
- fabric: polyamide yarn;
- dim.: 400 x 300 cm

MANIPULATIVE BOARDS



**Royal.
Manipulative board
NS9092**

- manipulation board, kingdom themed;
- it is equipped with 1 movable element, 6 elements with texture and 4 rotating elements;
- the board is made of MDF board with a print;
- dim.: 130 x 79 cm



Wave

The blues and turquoises of the sea, shoals of fish and seashells are the leading motifs of the Wave collection. Set out on a sea voyage in a yellow submarine or sit down on the carpet to listen to mysterious sea stories.





**Storage unit Submarine
on a plinth NS1848**

- dim.: 82 x 38 x 43 cm



**Shelving unit Blue Wave
with legs FN1854
on a plinth NS1854**

- dim.: 82 x 38 x 84 cm

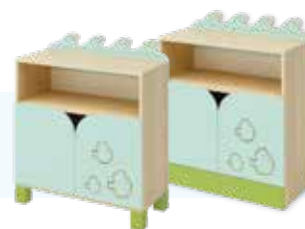

**Storage unit Wave
with legs FN1849
on a plinth NS1849**

- dim.: 82 x 38 x 84 cm



**Storage unit Whale
with legs FN1850
on a plinth NS1850**

- dim.: 82 cm x 38 cm x 84 cm



**Storage unit with sliding doors
with legs FN1855
on a plinth NS2875**

- dim.: 82 x 37 x 111 cm



**Locker unit Wave
with legs FN1856
on a plinth NS2876**

- dim.: 82 x 38 x 84 cm;
- 9 lockers, 22 x 25 cm



**Shelving unit Little Whale
with legs FN1851
on a plinth NS1851**

- dim.: 41 cm x 38 cm x 125 cm



**Shelving unit Blue Cloud
with legs FN1853
on a plinth NS1853**

- dim.: 41 cm x 38 cm x 166 cm



**Storage unit Lighthouse
with legs FN1852
on a plinth NS1852**

- dim.: 82 cm x 38 cm x 166 cm

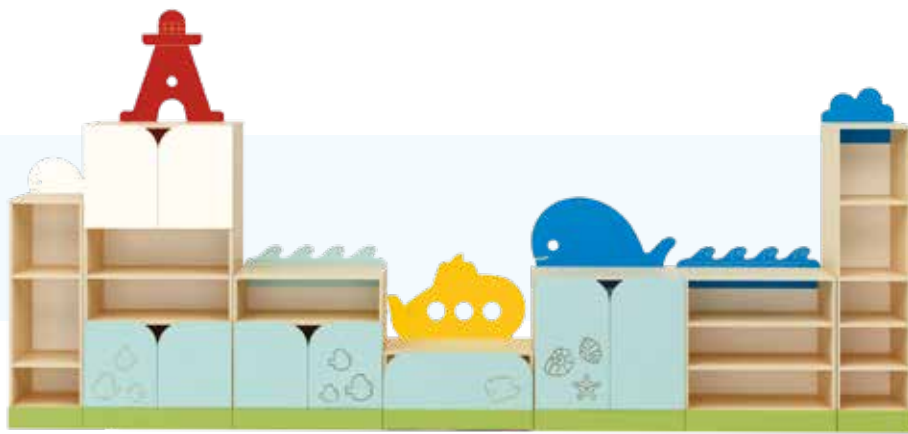

492 cm

Wave. Set 1
NS1845

total length 492 cm

- NS1848
- NS1849
- NS1850
- NS1851
- NS1852
- NS1853
- NS1854



369 cm

Wave. Set 2
NS1846

total length 369 cm

- NS1848
- NS1849
- NS1850
- NS1853
- NS1854



287 cm

Wave. Set 3
NS1847

total length 287 cm

- NS1848
- NS1850
- NS1853
- NS1854

DESKS



**Crab desk
NS2870**

- dim.: 120 x 51 x 76,5 cm

SHELVES



**Jellyfish. Wall shelf
NS2877**

- dim.: 46 x 16 cm

CARPETS



**Wave. Fantasy polyamide carpet
MU0003**

Big carpet "Wave" perfect for nurseries and kindergartens. This product will complement any interior as well as create space for relaxation or playtime.

The fabric is resistant to abrasion. It also has anti-microbial and anti-mould properties. The carpet is easy to clean.

- colours do not fade;
- fabric: polyamide yarn;
- dim.: 400 x 300 cm

MANIPULATIVE BOARDS



**Wave. Manipulative board
NS9091**

- manipulation board, sea themed;
- it is equipped with 2 movable elements,

- 2 elements with texture, 1 mirror, 3 Velcro elements and 1 plexi rotating element;
- the board is made of MDF board with a print;
- dim.: 130 x 79 cm



PASTEL RAINBOW

Furniture collections Rainbow and Pastel stand out thanks to their functional and practical design which gives you the freedom to arrange the interior according to your individual needs. Equally important is the fact that each child in the group will have enough space to keep their things. Colours such as cream, green, mint, and blue in the Pastel collection will have a calming effect while delicate, subdued colours of the Rainbow collection will create a cheerful atmosphere. Cabinets with shelves are sold together with matching doors which can open on the left side or on the right side. The frame is made of laminated board in birch colour. The back and front walls are made of MDF board in blue, light-

green, cream, and mint colour (Pastel) as well as blue, green, yellow, and red (Rainbow).

The collection includes:

- Big module (9 compartments with shelves), dim.: 99 x 35 x 112 cm
- Small module (6 compartments with shelves), dim.: 66,5 x 35 x 112 cm
- Module 1 (6 compartments with shelves), dim.: 99 x 35 x 81 cm
- Module 4 (3 compartments with shelves), dim.: 99 x 35 x 113 cm
- Module 2 (3 compartments with shelves), dim.: 99 x 35 x 113 cm
- Module 3 (3 compartments with shelves), dim.: 99 x 35 x 113 cm
- Cabinet with shelves (4 shelves), dim.: 86 x 40 x 192 cm

BODY:

board: chipboard

thickness: 18 mm

colour: birch



base: board

SHELVES:

board: chipboard

thickness: 18 mm

colour: birch, white



board: MDF

thickness: 6 mm

DOORS:

type: opened

board: MDF

thickness: 12 mm

surface: smooth

colour:



lock: no

HANDLES:

type of handle: wooden ball



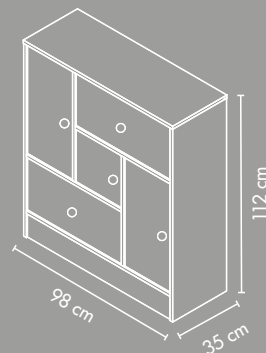
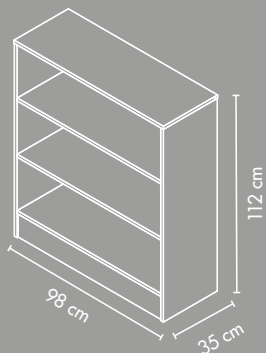
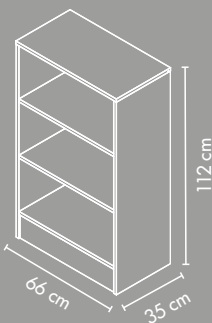
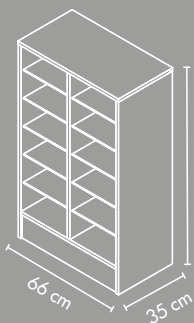
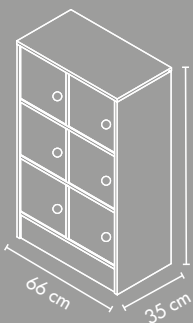
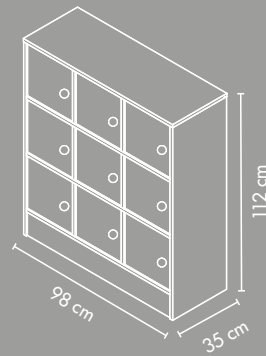
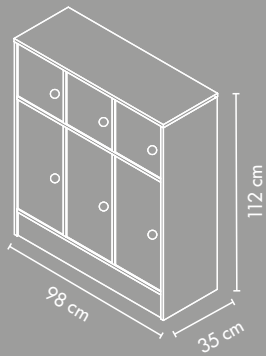
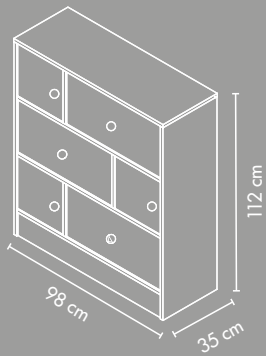
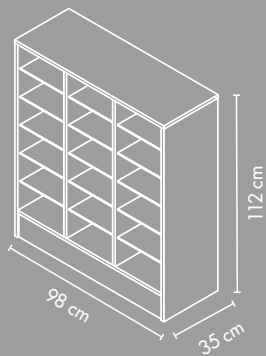

PASTEL & RAINBOW FURNITURE

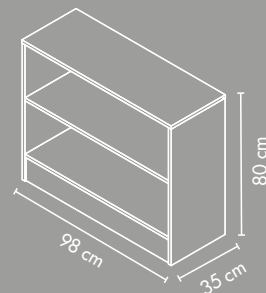
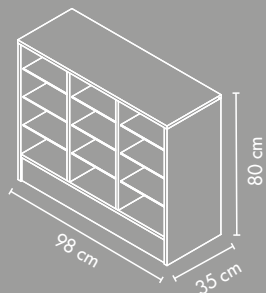
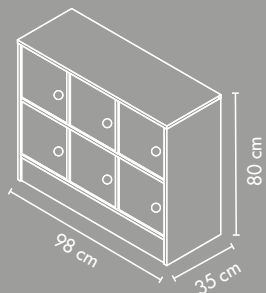
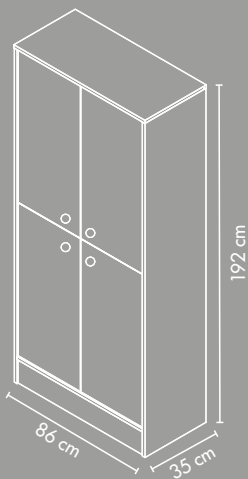

FEATURES

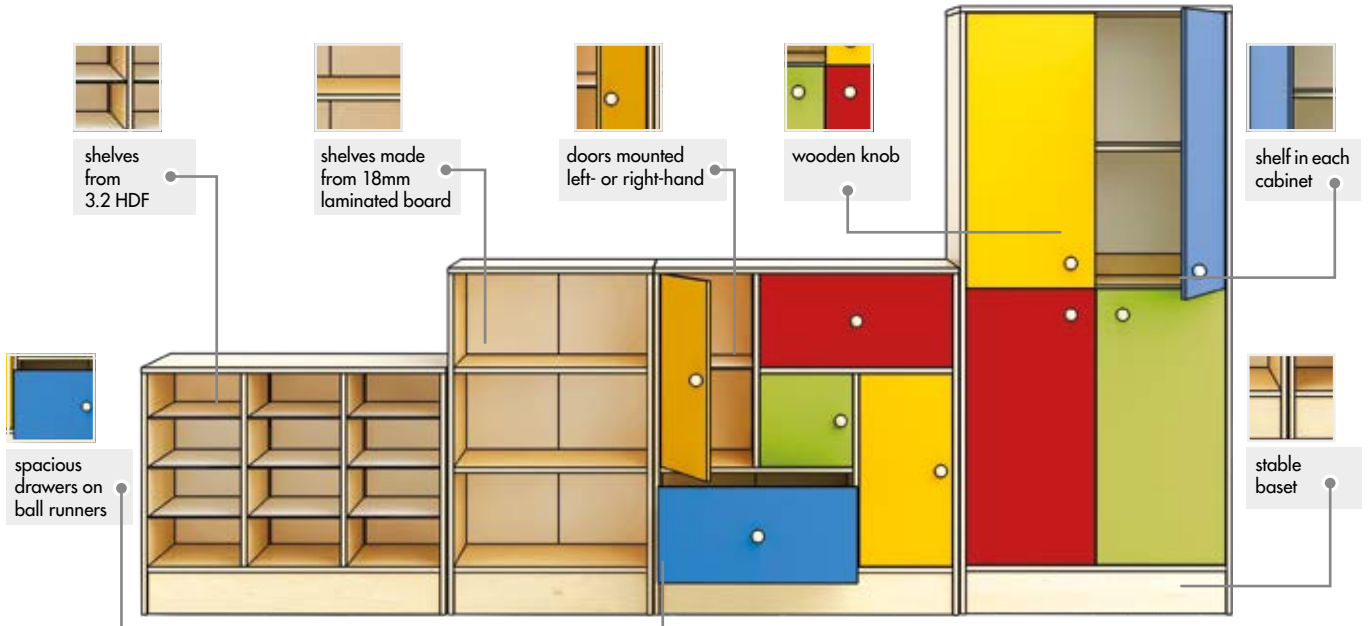
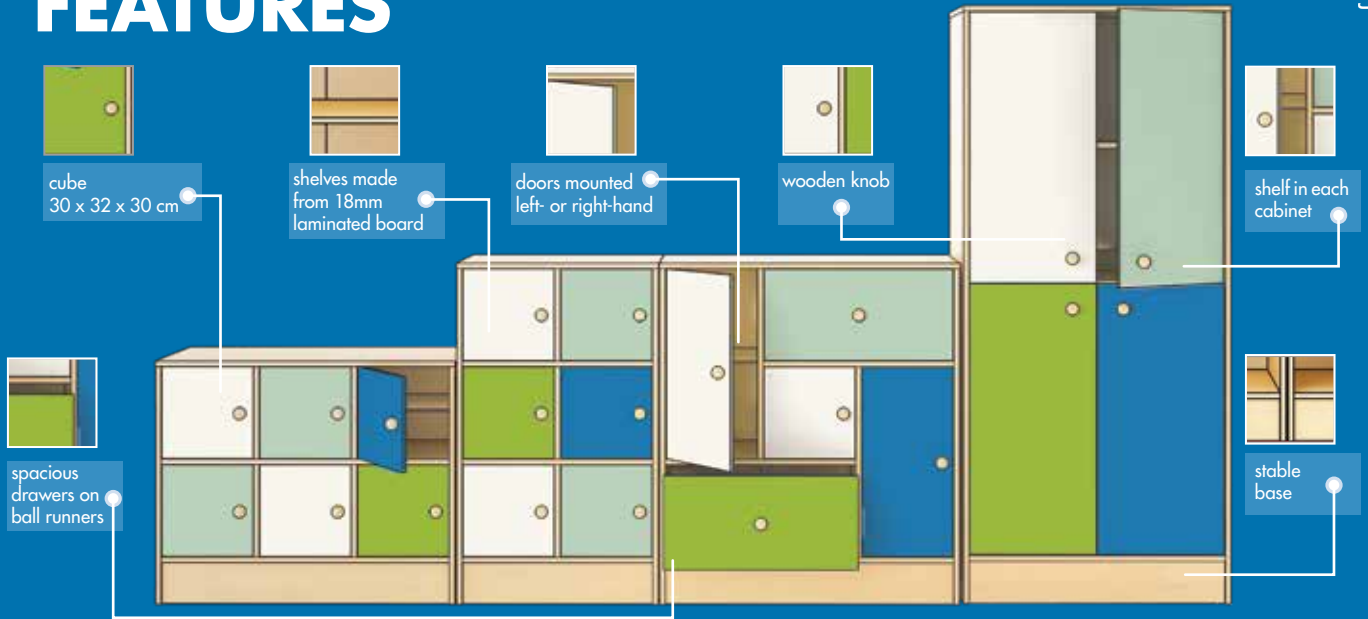



Module 1
PASTEL NP3201
RAINBOW NS0468B

- dim.: 99 x 35 x 81 cm;
- 6 lockers with shelves

Small module
PASTEL NP2301
RAINBOW NS0469

- dim.: 65 x 35 x 113 cm;
- 6 lockers with shelves

Big Module
PASTEL NP3301
RAINBOW NS0468

- dim.: 99 x 35 x 112 cm;
- 9 lockers with shelves

Module 2
PASTEL NP3361
RAINBOW NS0468C

- dim.: 99 x 35 x 113 cm;
- 6 lockers with shelves

**Module 4**

RAINBOW **NS0468E**
PASTEL **NP3331**

- dim.: 99 x 35 x 113 cm;
- 3 lockers with shelves and 3 drawers

**Module 3**

RAINBOW **NS0468D**
PASTEL **NP3391**

- dim.: 99 x 35 x 113 cm;
- 3 lockers with shelves and 2 drawers

**Tall cabinet with shelves**

RAINBOW **NS1468**
PASTEL **NP6001**

- dim.: 86 x 35 x 192 cm;
- 4 shelves



Module A
NS0469/1

- dim.: 65 x 35 x 113 cm



Module C
NS0469/3

- dim.: 99 x 35 x 81 cm



Module B
NS0469/2

- dim.: 99 x 35 x 113 cm



Module 6
NS0468/G

- dim.: 99 x 35 x 81 cm



RAINBOW



RAINBOW 1

Furniture set - Rainbow I NS4066

Total length of the set: 164 cm,
depth: 35 cm, height

- NS0469
- NS0468

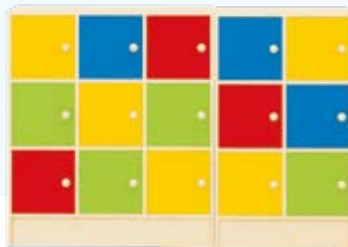

164 cm

RAINBOW 2

Furniture set - Rainbow II NS4067

Total length of the set: 328 cm,
depth: 35 cm.

- NS0469 x 2
- NS4068 x 2



328 cm

PASTEL

PASTEL 1

Furniture set - Pastel I NP3359

Total length of the set: 348 cm, depth: 35 cm, height ranging from 80 cm to 192 cm.

- NP2301
- NP3331
- NP3201
- NP6001



348 cm

PASTEL 2

Furniture set - Pastel II NP3360

Total length of the set: 457 cm, depth: 35 cm, height ranging from 80 cm to 112 cm.

- NP3361
- NS0469/3
- NS0469/1
- NP2301
- NP3301



457 cm





The Cubo series combines functionality and individual character within the classic style. The furniture is notable for its original design and lightness of its shapes. You can create unique arrangements of elements, sets, accessories and colours according to your taste. With this diversity of solutions, the product is particularly useful in classrooms. The shapes have been designed so that their spacious insides are always easily accessible.

- 23 sets in various dimensions

accessories:

- 6 types of top add-ons: (76 x 40 x 37 cm, 76 x 40 x 75 cm);
- 2 types of shelves: narrow (35 x 36 cm), wide (73 x 36 cm);
- 2 types of cubby holes: narrow (35 x 36 x 36 cm), wide (73 x 36 x 36 cm);
- 3 types of bins: small (37 x 36 x 34 cm), medium (74 x 36 x 34 cm), and large (112 x 36 x 34 cm);
- 3 door sizes either swing direction: (37 x 37 cm, 37 x 74 cm, 37 x 112 cm);

- 4 types of drawers: narrow (37 x 37 x 18 cm), wide (74 x 37 x 37 cm), deep (37 x 37 x 37 cm), shallow (74 x 37 x 15 cm);
- plastic trays: shallow, deep and maxi in 6 colours;
- ergonomic plastic handles;
- laminated board body in birch finish
- fronts of drawers, doors, chests, cubby holes in 5 colours: blue, white, grey, yellow, green
- all accessories (bins, decorative back panels, doors) sold separately

BODY:

board: chipboard
colour: birch



thickness: 18 mm
base: board

DOORS:

type: opened
board: chipboard
surface: smooth
colour:



thickness: 18 mm

type of handle:
cutout

lock: yes

SHELVES:

board: chipboard
colour: birch



thickness: 18 mm

PLASTIC TRAYS:

colour:



DRAWERS/ CONTAINERS:

board: chipboard
/ MDF

front colour:



UNIT 1

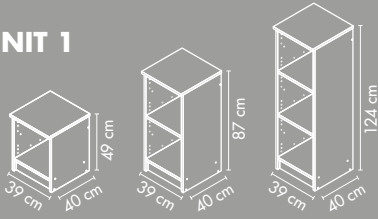

ADD-ON

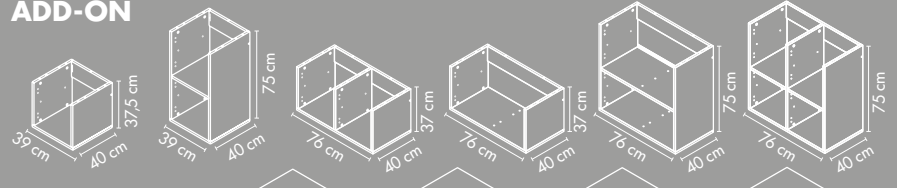

UNIT 2

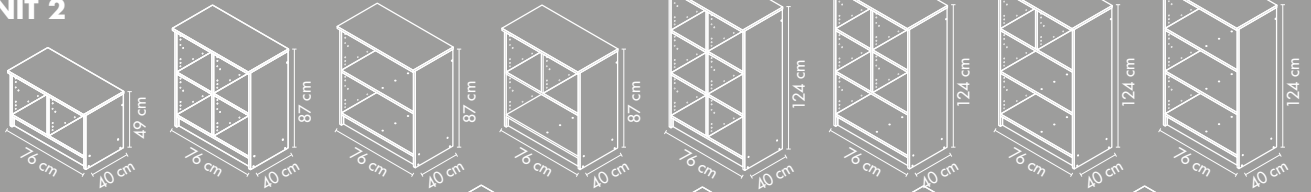

UNIT 3

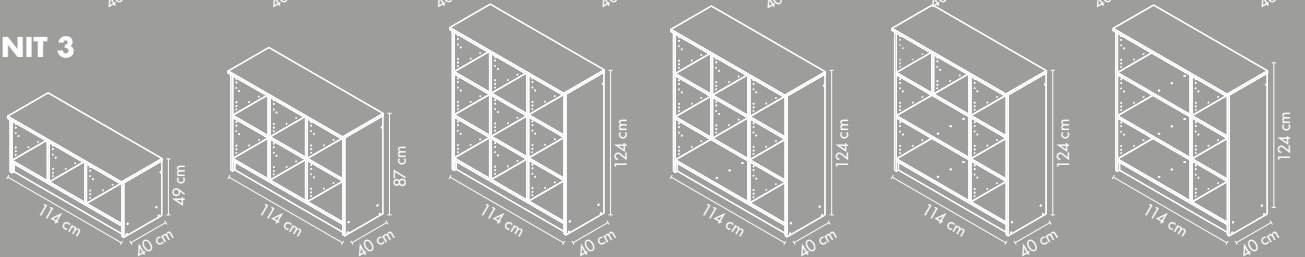

FEATURES



All accessories - trays, drawers, canopies, doors - sold separately

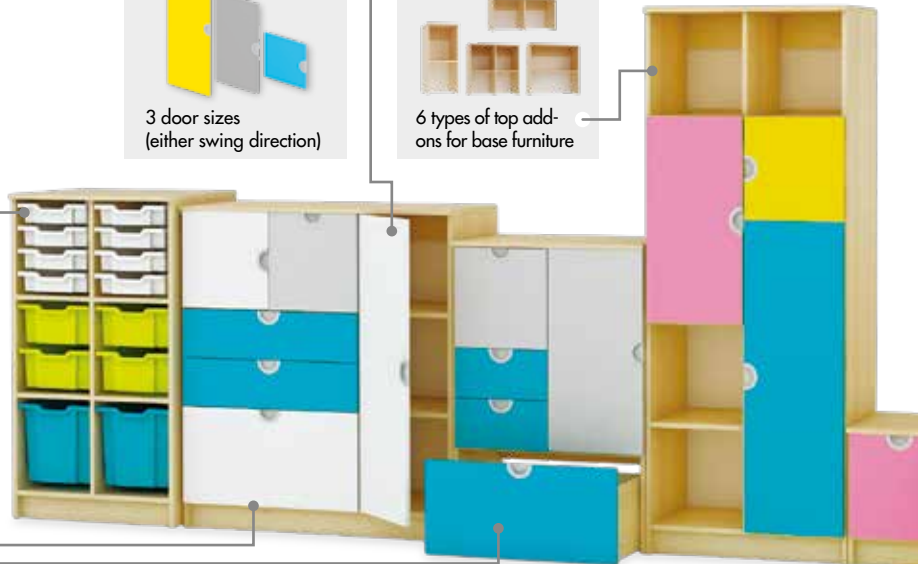
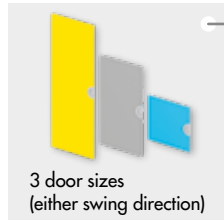
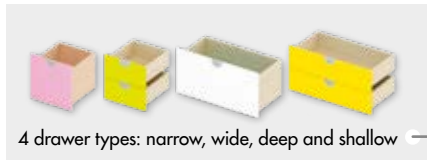

FOR CONTAINERS

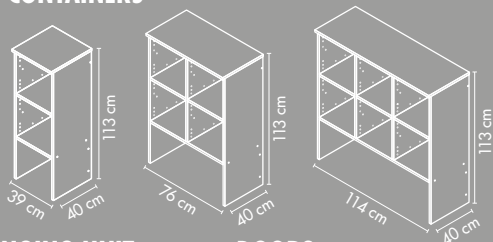

CANOPIES

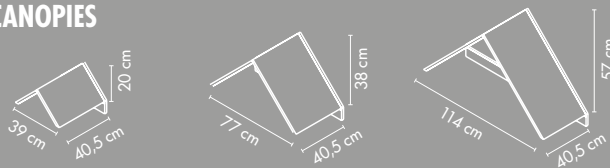

CHANGING UNIT

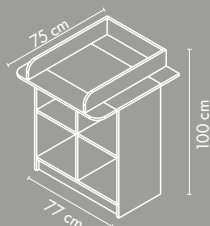

DOORS

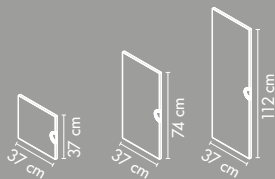

DRAWERS

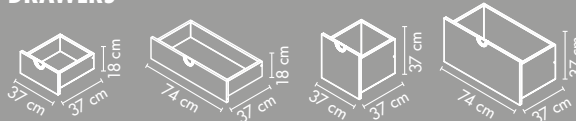

CONTAINERS

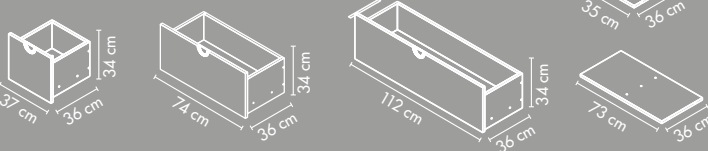

SHELVES

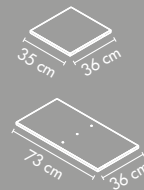

drawers and doors available in 6 colours



ergonomic plastic handles

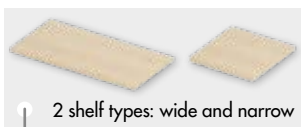

2 shelf types: wide and narrow



3 size canopies for furniture

30 basic modules



shallow drawer: 35 x 36 x 36 cm
deep drawer: 73 x 36 x 36 cm



BASIC MODULES

UNIT 1



Small 1
NC1101



Medium 2
NC1201



Tall 3
NC1301



ADD-ON

Add-on for the tall Cubo basic modules unit allows you to organize the space for taking care of the baby. Raised sides protect the baby from falling out. Our offer includes single and double add-ons as well as comfortable mattresses dedicated to them (sold separately).

Ready Configuration



Single add-on for the basic modules unit 1 tall 3
NC0201

- dim.: 39,2 x 38 x 37,4 cm;
- material: birch chipboard 18 mm



Double add-on for the basic modules unit 1 tall 3
NC0301

- dim.: 39,2 x 38 x 74,8 cm;
- material: birch chipboard 18 mm

UNIT 2



Small 2
NC2101



Medium 4
NC2201



Medium cabinet
NC2211



Medium 2s
NC2221



Tall 6
NC2301



Tall 4+1s
NC2311



Tall 2+2s
NC2321



Tall 3s
NC2331

ADD-ON + ANY UNIT 2 = EVEN MORE NEW ARRANGEMENTS

These units are NOT freestanding and needs to be attached to another piece of furniture (Unit 2).



Low 2
NC0401



Low 1s
NC0411



Tall 4/1
NC0501



Tall 2s
NC0521



UNIT 3



Small 3
NC3101



Medium 6
NC3201



Tall 9
NC3301



Tall 7+1s
NC3311



Tall 4+2s
NC3321



Tall 3+3s
NC3331

FOR CONTAINERS



Mala 2
NC1261



Mediuma 4
NC2261



Tall 6
NC3261



MATS FOR CABINETS

Practical and comfortable mattress in combination with Cubo basic modules unit creates a functional seat for nurseries, kindergartens and classrooms as well as therapy offices. It provides space for playing, learning, reading or relaxing, but will also work perfectly in cloakrooms and waiting rooms. This product is made of polyurethane foam with increased density and phthalate-free PVC fabric, which is easy to clean and disinfect. The mattress is attached to the seat base with Velcro. Available in two sizes and 6 colours.

To be attached by tape placed on the bottom of the mattresses



Small 2
NC2101



Small 3
NC3101



Sitting mattress for the small cabinet 2

- dim.: 77 x 41 x 3 cm; material: polyurethane foam, PVC fabric



Grey
NS3242



White
NS3243



Lime
NS3244



Marine
NS3245



Yellow
NS3246



Pink
NS3247

Sitting mattress for the small cabinet 3

- dim.: 114,5 x 41 x 3 cm; material: polyurethane foam, PVC fabric



Grey
NS3252



White
NS3253



Lime
NS3254



Marine
NS3255



Yellow
NS3256



Pink
NS3257

HANGING CABINETS

Practical hanging cabinets which complement the Cubo collection. They will allow you to create a functional space with plenty of room for storage.



Hanging cabinet 1. Cubo collection
NC7101

- dim.: 39 x 32 x 40 cm



Hanging cabinet 2. Cubo collection
NC7201

- dim.: 76 x 32 x 40 cm



Hanging cabinet 3. Cubo collection
NC7301

- dim.: 114 x 32 x 40 cm

Doors sold separately, available
in 6 colours on page 79





MOBILE CABINETS



Cubo mobile dress-up unit NC8011

This mobile cabinet for easy storage of theatre costumes has a bar for hangers and two top-open boxes for smaller elements of costumes.

- dim.: 120 x 50 x 120 cm;
- 2 boxes, bar, 5 castors (2 lockable);
- laminated particle board (birch), plastic, metal

bar for hangers

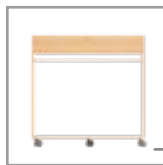

extra castor close to shelf



two top-open boxes for smaller elements

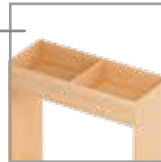

lockable castors

MOBILE CABINET FOR DRAWERS



fits narrow deep or shallow CUBO drawers



equipped with an open shelf and drawers with access on both sides



Cubo. Mobile cabinet for drawers NC4100

Mobile cabinet providing functional storage space for sport accessories, musical instruments, art&craft materials. It can also be used as a container for a

two-station desk. Equipped with an open shelf and drawers with access on both sides. Wheels make moving the cabinet with its contents easier.

- dim.: 76,6 x 72,6 x 86,7 cm (without wheels)



Drawers available on page 78





20 types of musical instruments MOBILE CABINET WITH MUSICAL INSTRUMENTS



Cubo. Mobile cabinet with musical instruments NC4200

Mobile cabinet providing functional storage space for sport accessories, musical instruments, art&craft materials. It can also be used as a container for a two-station desk. Equipped with an open shelf and white, grey and lime coloured drawers with access on both sides (drawers sold separately). Wheels make moving the cabinet with its contents easier.

- dim.: 76,6 x 72,2 x 86,7 cm (without wheels);
- material: birch-coloured chipboard;
- 4 plastic wheels;
- 4 drawers;
- 20 kinds of musical instruments

ART. CABINET



large open shelves for storing



convenient access both sides cabinets



fits narrow deep or shallow CUBO drawers

Drawers available on page 78



wheels make it easy to move



Cubo. Art Cabinet Turtle NC4001

Double-sided cabinet for art supplies. Equipped with open shelves for storing A3 and A4 brystols. Containers on the sides provide space for painting materials, paints and crayons. Spacious shelves enables safe

storage of items and articles that should not be easily accessible or require special storage. Wheels make it easy to move the cabinet to another place.

- dim.: 59 x 77 x 58 cm;
- material: birch-coloured chipboard;
- drawers sold separately



DRAWERS

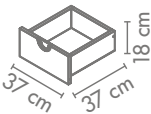

narrow shallow

• 2 pcs

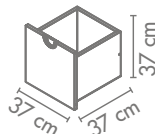

narrow deep

• 1 pc

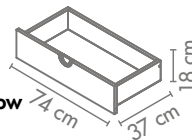





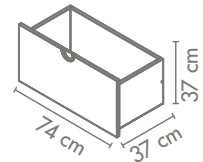

wide shallow

• 2 pcs



wide deep

• 1 pc

NC0012	NC0022		NC0032	NC0042
NC0013	NC0023		NC0033	NC0043
NC0014	NC0024		NC0034	NC0044
NC0015	NC0025		NC0035	NC0045
NC0016	NC0026		NC0036	NC0046
NC0017	NC0027		NC0037	NC0047

CONTAINERS



Wide
• 1 pc

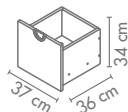

Medium
• 1 pc

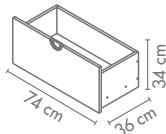

Narrow
• 1 pc

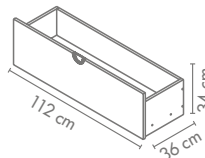

	NC9102
	NC9103
	NC9104
	NC9105
	NC9106
	NC9107

	NC9202
	NC9203
	NC9204
	NC9205
	NC9206
	NC9207

	NC9302
	NC9303
	NC9304
	NC9305
	NC9306
	NC9307

DOORS

		NC0092
		NC0093
		NC0094
		NC0095
		NC0096
		NC0097

Tall

- dim.: 112 x 37 cm;
- 1 pc

		NC0082
		NC0083
		NC0084
		NC0085
		NC0086
		NC0087

Medium

- dim.: 74 x 37 cm;
- 1 pc

		NC0072
		NC0073
		NC0074
		NC0075
		NC0076
		NC0077

Low

- dim.: 37 x 37 cm;
- 1 pc

SHELVES



Small shelf
NC0051

- dim.: 35 x 36 cm



Large shelf
NC0061

- dim.: 73 x 36 cm









CANOPIES

UNIT 1

Canopies are suitable only for basic units

- canopy, dim.: 39 x 40 x 19,6 cm;
- type: add-on;
- available in grey, white, lime, teal, yellow, rosy colours;
- 18 mm thick



	NC6112
	NC6113
	NC6114
	NC6115
	NC6116
	NC6117

Canopies combining functionality and style for the Cubo line furniture. They are perfect for designing interesting and practical interiors which encourage fun







and learning. The canopies are available in six colours and three sizes and can be attached to all Cubo units.

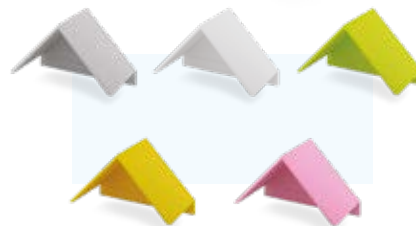

UNIT 2

- canopy with 1 niche;
- dim.: 76 x 40 x 38 cm;
- type: add-on; it is made of grey, white, lime, teal, yellow, rosy chipboard;
- 18 mm thick



	NC6212
	NC6213
	NC6214
	NC6215
	NC6216
	NC6217









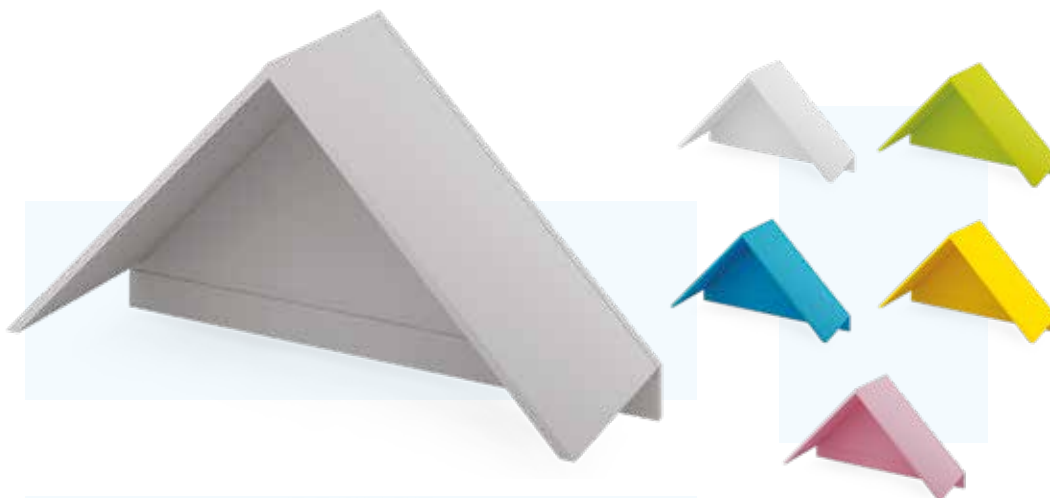

UNIT 3

- canopy with 1 niche;
- dim.: 114 x 40 x 57 cm;
- type: add-on; it is made of grey, white, lime, teal, yellow, rosy chipboard;
- 18 mm thick



	NC6312
	NC6313
	NC6314
	NC6315
	NC6316
	NC6317



READY FURNITURE



Modul 1
ZC1100

- dim.: 39 x 40 x 49 cm



Modul 2
ZC1200

- dim.: 39 x 40 x 97 cm



Modul 3
ZC1300

- dim.: 39 x 40 x 124 cm



Modul 7
ZC2200

- dim.: 76 x 40 x 87 cm



Modul 8
ZC2201

- dim.: 76 x 40 x 87 cm



Modul 9
ZC2300

- dim.: 76 x 40 x 124 cm



Modul 10
ZC2301

- dim.: 76 x 40 x 124 cm



Modul 6
ZC2602

- dim.: 76 x 40 x 113 cm



Modul 11
ZC2302

- dim.: 76 x 40 x 124 cm



Modul 4
ZC2600

- dim.: 76 x 40 x 113 cm



Modul 5
ZC2601

- dim.: 76 x 40 x 113 cm

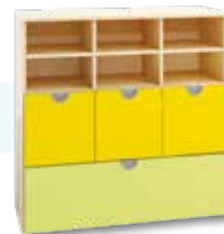

Modul 17
ZC3601

- dim.: 114 x 40 x 113 cm

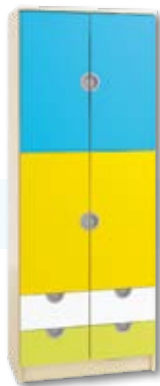

Modul 12
ZC2500

- dim.: 76 x 40 x 199 cm



Modul 13
ZC2501

- dim.: 76 x 40 x 199 cm



Desk
BC0001

- dim.: 115 x 48 x 77,5 cm



Modul 19
ZC3602

- dim.: 114 x 40 x 113 cm



Cuboo



Modul 14
ZC3100

- dim.: 114 x 40 x 49 cm



Modul 15
ZC3200

- dim.: 114 x 40 x 87 cm



Modul 21
ZC3301

- dim.: 114 x 40 x 124 cm



Modul 22
ZC3302

- dim.: 114 x 40 x 124 cm



Modul 16
ZC3201

- dim.: 114 x 40 x 87 cm



Modul 18
ZC3300

- dim.: 114 x 40 x 113 cm



Modul 23
ZC3303

- dim.: 114 x 40 x 124 cm



Modul 20
ZC3600

- dim.: 114 x 40 x 124 cm



Module 25
ZC2410

- dim.: 76 x 40 x 162 cm, 18 mm thick laminated board frame, pair of chipboard doors with white fronts, 18 mm thick tall drawer chipboard fronts in rosy and grey colour, plastic handles



Module 24
ZC3260

- dim.: 114 x 40 x 124 cm, 18 mm thick laminated board frame, colour: birch, 18 mm thick, tall chipboard drawer fronts in yellow, 18 mm thick front of the chipboard box in rosy colour, plastic handles

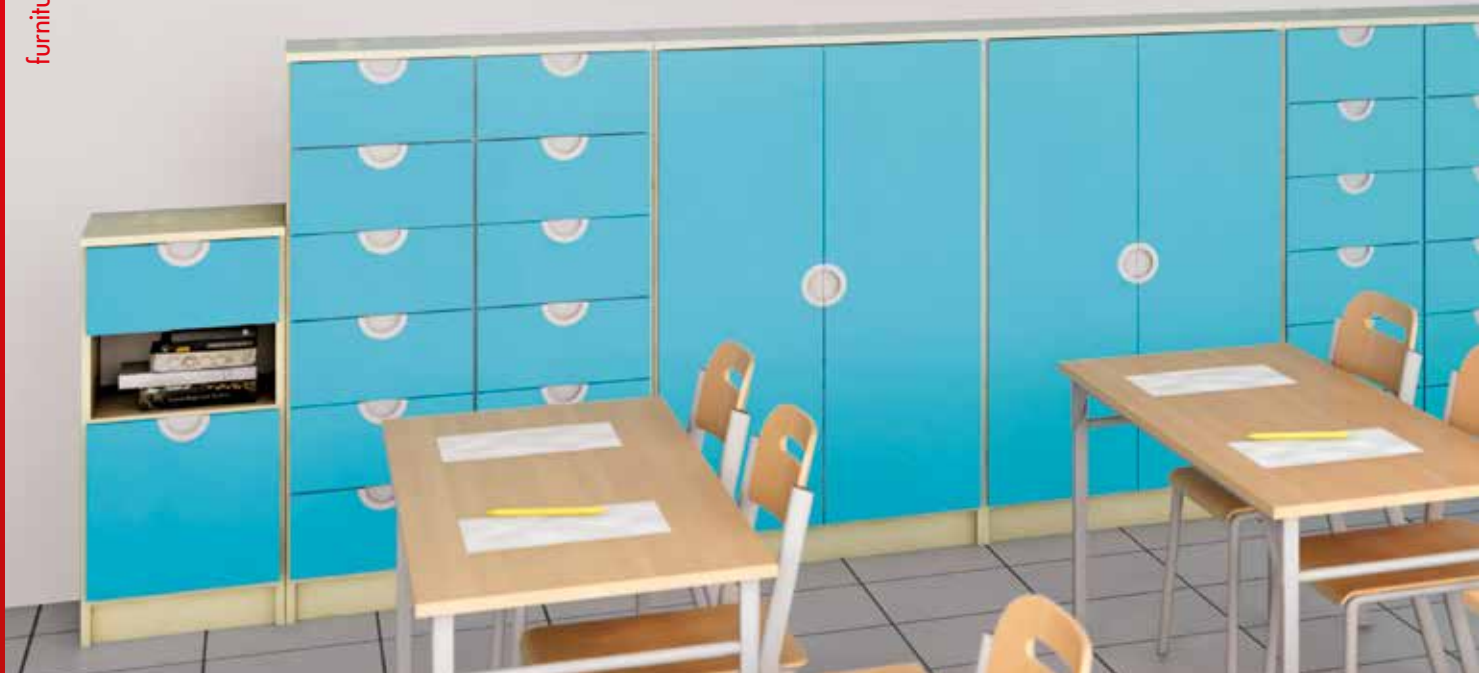

SETS

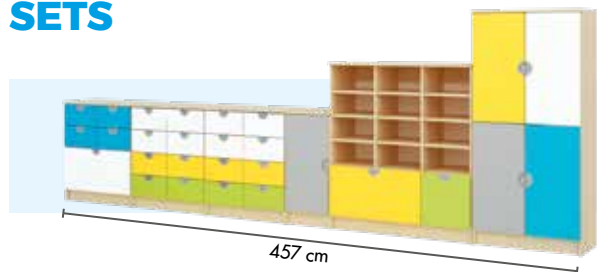

CUBO0001



CUBO0002

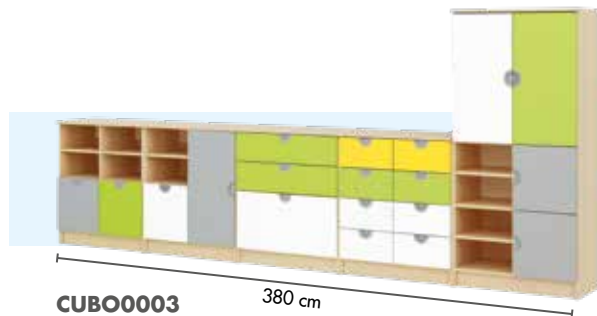

CUBO0003

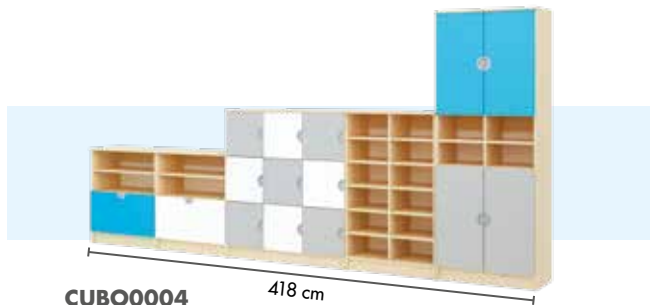

CUBO0004

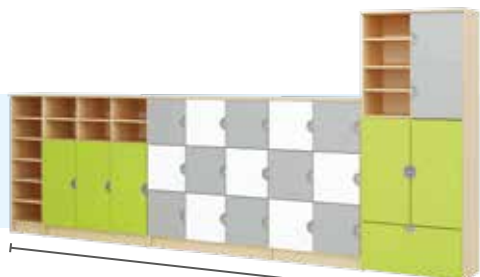

CUBO0005

419 cm

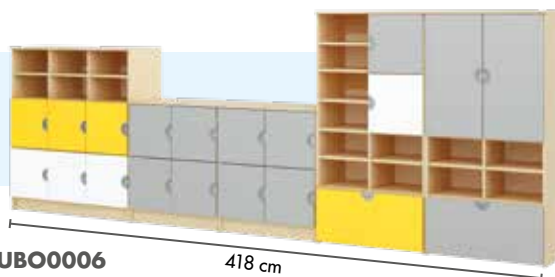

CUBO0006

418 cm



CUBO0007

382 cm

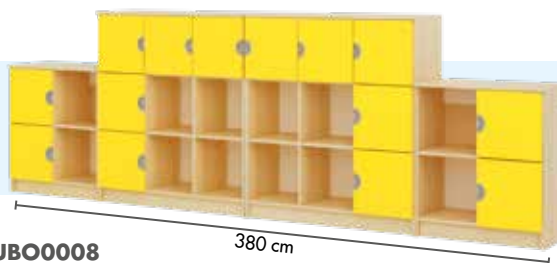

CUBO0008

380 cm

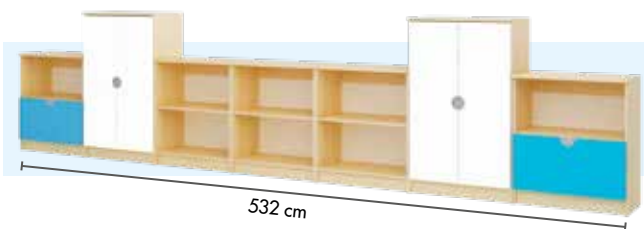

CUBO0009

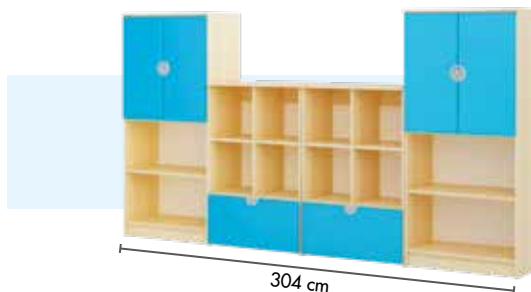

CUBO0010

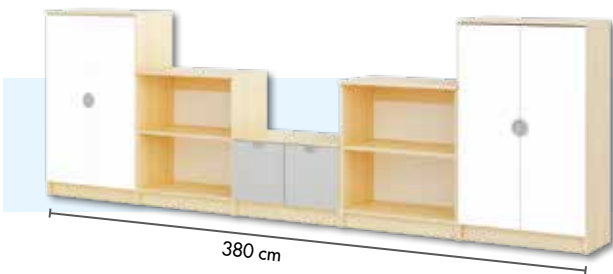

CUBO0011



CUBO0012

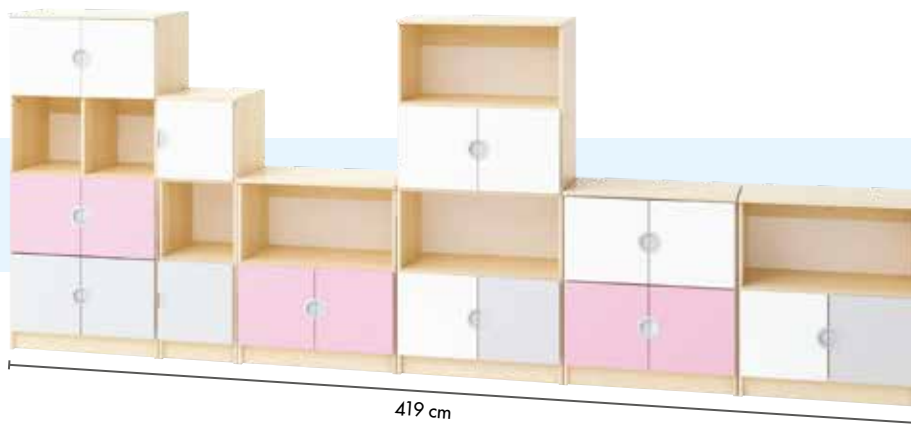

CUBO0013

419 cm

UNITS FOR PLASTIC TRAYS

CABINETS

- type: standalone; it is made of 18 mm thick chipboard in birch colour, dim.: 32,1 x 41,1 cm, made of 18 mm thick birch-coloured chipboard;
- possible equipment (sold separately): containers

CABINETS FOR PLASTIC TRAYS
ARE 5 CM DEEPER THAN
STANDARD CUBO CABINETS

Plastic trays available
on page 92



SMALL



Cabinet 1
NC1191

- dim.: 36 x 45 x 50 cm; birch



Cabinet 2
NC2191

- dim.: 70 x 45 x 50 cm; birch



Cabinet 3
NC3191

- dim.: 104 x 45 x 50 cm; birch

MEDIUM



Cabinet 2
NC1291

- dim.: 36 x 45 x 87 cm; birch



Cabinet 4
NC2291

- dim.: 70 x 45 x 87 cm; birch



Cabinet 6
NC3291

- dim.: 104 x 45 x 87 cm; birch

TALL



Cabinet 1
NC1391

- dim.: 36 x 45 x 125 cm; birch



Cabinet 6
NC2391

- dim.: 70 x 45 x 125 cm; birch



Cabinet 9
NC3391

- dim.: 104 x 45 x 125 cm; birch



TRAYS

Plastic containers for Cubo, Fresh and Modern line furniture. They are perfect for implementing creative storage ideas. The wide selection of colours and sizes allows you to create unique arrangements which can be easily modified at any time. All containers are made of durable material.

- in the shape of a rectangle; material: plastic; intended use: storage



Plastic runners included in the set !



3 pcs

	NS2356		NS2331
	NS2357		NS2330
	NS2358		NS2301
	NS2359		NS2300

SHALLOW

- dim.: 31 x 42 x 7 cm



4 pcs

	NS2383		NS2381
	NS2386		NS2382
	NS2384		NS2397
	NS2385		NS2396

MAXI

- dim.: 31 x 42 x 30 cm



1 pc

	NS2348		NS2352
	NS2349		NS2353
	NS2350		NS2355
	NS2351		NS2354



4 pcs

	NS2360		NS2333
	NS2361		NS2332
	NS2362		NS2303
	NS2363		NS2302



6 pcs

	NS2368		NS2335
	NS2369		NS2334
	NS2370		NS2305
	NS2371		NS2304

DEEP

- dim.: 31 x 42 x 16 cm

CABINETS FOR PLASTIC TRAYS ARE 5 CM DEEPER THAN STANDARD CUBO CABINETS



2 pcs

	NS2317		NS2315
	NS2320		NS2316
	NS2318		NS2327
	NS2319		NS2326



6 pcs

	NS2364		NS2337
	NS2365		NS2336
	NS2366		NS2307
	NS2367		NS2306



8 pcs

	NS2372		NS2339
	NS2373		NS2338
	NS2374		NS2309
	NS2375		NS2308

INSERTS

Inserts for plastic trays

- recommended for shallow trays
- polystyrene
- dim.: 40 x 275 x 388 mm
- thickness: 1,5 mm



- 4 compartments
NS1377



- 6 compartments
NS1376



- 8 compartments
NS1375



READY FURNITURE WITH TRAYS

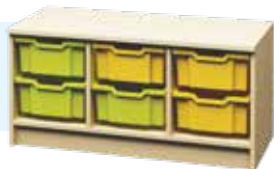

Module 26
ZC3101

- dim.: 104 x 45 x 50 cm



Module 27
ZC1202

- dim.: 36 x 45 x 87 cm



Module 28
ZC2203

- dim.: 70 x 45 x 87 cm



Module 29
ZC1304

- dim.: 35,9 x 45 x 124,6 cm



Module 30
ZC2305

- dim.: 70 x 45 x 125 cm



Module 31
ZC3306

- dim.: 104 x 45 x 125 cm

SETS

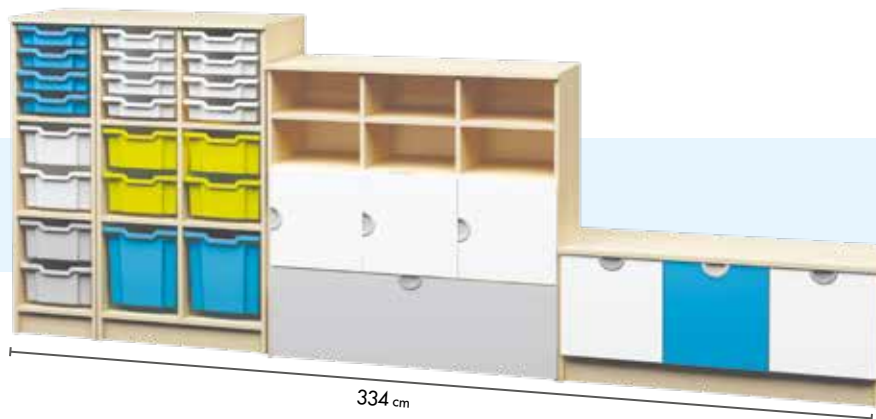

CUBO0015

334 cm



CUBO0014

434 cm

HIDING HOUSES

REGULAR

Specially designed for nursery and preschool rooms. An ideal base for play and a hiding place for those toddlers who need to quieten down or temporarily separate from the group. It is a cosy space to guarantee a feeling of security. The soft mattress inside is moulded so as to allow

the child to lie down or to sit. Because of its height the den requires attachment to a wall. The mattress comes in 2 colours and is sold separately.

- dim.: 153 x 54 x 149 cm;
- colour: birch, green, white, rosy, blue, grey;
- material: laminated particleboard 18 mm



**Cubo sensory den
NC0202**

- colour: birch, green, white, rosy, blue, grey

**Cubo. Calming Hiding House grey-white
NC0203**

- colour: white-grey

MATTRESS FOR THE HIDING HOUSE

- dim.: 126,4 x 50 x 58 cm (at highest point);
- material: foam, PVC fabric



- Grey
NS1202



- White
NS1203



- Lime
NS1204

MAXI

Children have their own world. Sometimes they need a place to relax, calm down, day dream or read a book. Especially if they spend a lot of time in kindergarten or school. This hiding-house gives them possibility both to isolate themselves for a while and learn to be alone, as well as to play and talk with peers. It can also help to build socio-emotional relations. Depending on the needs, we offer three models of hiding-houses with a

solid structure made of laminated chipboard. Each house is equipped with seats and wall panels made of polyurethane foam and phthalate-free PVC fabric, which is easy to clean. There is space under the seats for toys, backpacks or shoes. For the more demanding, we have prepared a version of the hiding-house with storing space for books, magazines or toyboxes.



With corner seats

NC0211

- dim.: 130 x 108 x 210 cm, 4 corner seats with 4 wall panels;
- material: chipboard, polyurethane foam, PVC fabric, colour: birch



With couches

NC0212

- dim.: 130 x 108 x 210 cm, 2 double sofas with wall panel;
- material: chipboard, polyurethane foam, PVC fabric, colour: birch



With a couch and a cabinet

NC0213

- dim.: 130 x 108 x 210 cm, 1 double seat sofa with wall panel, bookcase with 9 shelves; material: chipboard, polyurethane foam, PVC fabric, colour: birch

CHANGING UNITS

If you combine the presented elements from the Cubo line, you can create a changing unit which is unique and safe for the little ones. The mattresses available in different colours allow you to customise the piece of furniture in order to match your interior.



**Cubo Changing Unit
NC0300**

- changing unit on socle with 4 niches;
- dim.: 77 x 74,5 x 100 cm; type: standalone;
- it is made of 18 mm thick chipboard in birch colour

**Add-in for the Cubo Changing Unit
NC0302**

- add-on with 3 niches; type: add-on; it is made of birch-coloured chipboard, 18 mm thick; 3 shelves made of 18 mm thick chipboard, dim.: 13 x 16,6 cm, in birch colour



STAIRS FOR CHANGING UNIT

Stairs with railings designed for the Cubo changing unit (NC0300). They allow children to step right up on their own. While this solution gives a chance for toddlers to train their skill of climbing the stairs, it facilitates the work of caregivers.

- dim.: 49,2 x 70 x 85 cm;
- 4 steps;
- material: sides made of MDF board, 12 mm thick, in white;
- stairs made of chipboard, 18 mm thick



**- Blue
NC0303**



**- Birch
NC0304**

ERGONOMIC MATTRESS FOR THE CUBO CHANGING TABLE

Mattress made of polyurethane foam with increased density. Covered with durable, phthalate-free PVC fabric, which is easy to clean. Intended for daily baby care and changing diapers. Raised sides of the mattress increase safety during hygienic activities.

- dim.: 50 x 70 x 15 cm;
- material: polyurethane foam, phthalate-free PVC fabric;
- additional information: suitable for Cubo changing unit NC0300

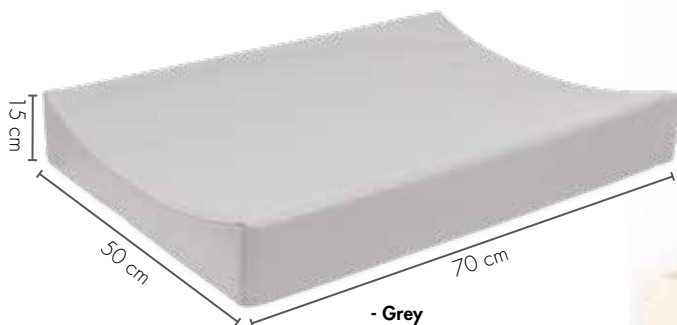

- Grey
NS3272



- White
NS3273



- Marine
NS3275



- Yellow
NS3276



- Lemon grass
NS3274



- Pink
NS3277

BEDDING CABINET

Cubo bed cabinet designed with the sleeping or lounging space in mind. Thanks to the wide selection of accessories in different colours, you can adjust your furniture piece so that it perfectly fits into the interior.

CABINET

Bed Cabinet NS2845

- wardrobe;
- dim.: 141 x 61 x 120 cm;
- type: standalone; it is made of 18 mm thick chipboard in birch colour;
- it is possible to buy additional equipment doors and curtain;
- the back is made of white MDF board, 3 mm thick



ADD ON

Bed and Bedding Cabinet NS2846

- wardrobe with 16 niches;
- dim.: 141 x 61 x 198,5 cm;
- type: standalone; it is made of 18 mm thick chipboard in birch colour;
- the wardrobe has 12 shelves made of MDF board, 6 mm thick, in white colour;
- it is possible to buy additional equipment: doors and curtain;
- the back is made of white MDF board, 3 mm thick



DOORS

	NC5102
	NC5103
	NC5104
	NC5105
	NC5106
	NC5107

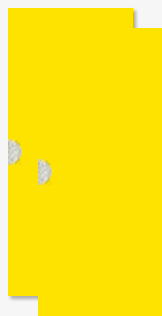

DOORS

	NC5002
	NC5003
	NC5004
	NC5005
	NC5006
	NC5007

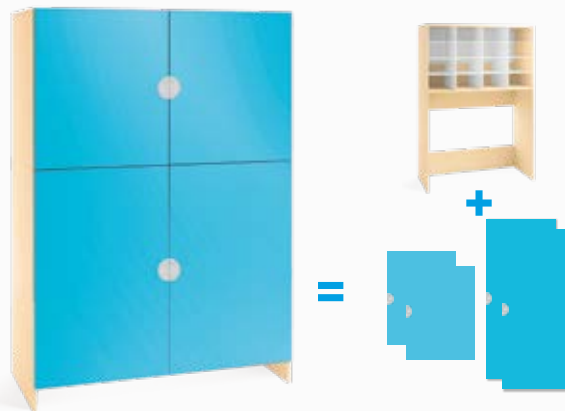



CLOAKROOMS



Cubo Cloakroom 3 NC8131

- dim.: 75 x 35 x 131 cm;
- 3 compartments, 3 yellow star-shaped triple hooks;
- shoe rack;
- laminated particle board (birch)



Cubo Cloakroom 6 NC8161

- dim.: 138 x 35 x 131 cm;
- 6 compartments, 6 yellow star-shaped triple hooks;
- shoe rack;
- laminated particle board (birch), metal, plastic

DOORS FOR CUBO CLOAKROOM UNIT

- 3 pcs (dim.: 21 x 21 cm);
- handle, laminated 18 mm particle board

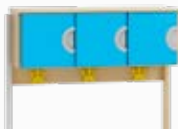

Grey
NC8232



White
NC8233



Lemon grass
NC8234



Blue
NC8235



Yellow
NC8236

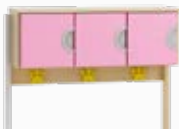

Pink
NC8237





CUSHIONS

Soft cushion made of high-quality phthalate-free PVC fabric. Outer material is easy to clean and disinfect. Filled with cut pieces of polyurethane foam which

provides comfortable support for the child's head. The cushion can be also used as a seat during playing on the floor. Available in different colour variants.

Complements furnitures from the Cubo series.

- dim.: 40 x 40 cm;
- material: PVC fabric, polyurethane foam cuttings



Grey
NS3262



White
NS3263



Lime
NS3264



Marine
NS3265



Yellow
NS3266



Pink
NS3267



Mix colour
NS3270



FRESH



Our furniture series Fresh allows for optimum adaptation of a room, while giving it lightness. This is possible thanks to the variety of wall cabinet and shelving types and all the cupboards are available in two sizes. Additionally, the legs and castors create an extra space which makes the room look larger, as well as providing easy access underneath for cleaning. The shelf units are available in several types and all the medium standing units in two width sizes.

The distinctive feature of the line are the colourful shelves; the distances between them allow for easy storage of documents and ring binders. The new version of Fresh furniture line helps arrange the classroom so as to display educational aids in a better way. Children may watch models and figures through the glass doors of cabinets to which, however, only the teacher has the keys. This line is particularly recommended for science classrooms, in which observation and

experimentation are the most commonly used teaching methods.

- 5 colour options: orange, green, white, grey and birch;
- two sizes of standing and hanging cabinets (92 and 47 cm);
- coloured shelves;
- plastic trays in 8 colours;
- handy handles (the colour matches that of the doors, drawers and shelves);
- easy assembly;
- sold with legs;
- plastic legs (orange, green or brown; 4 pieces, H 10 cm);
- accessories sold separately

BODY:

board: chipboard
thickness: 18 mm
colour: birch



base: legs/wheels

DOORS:

type: opened
surface: smooth
board: chipboard
thickness: 18 mm
colour:



type of handle:
plastic handle
lock: yes
board: glass

surface: smooth
thickness: 6 mm
type of handle:
metal handle
lock: yes

SHELVES:

board: chipboard
thickness: 18 mm
colour:



TRAYS:

material: plastic
colour:



LEGS:

material: plastic
colour:



WHEELS:

material: plastic and metal

UNITS

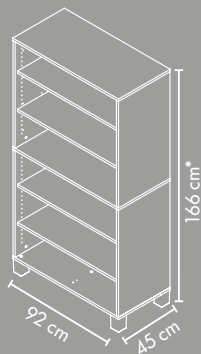

SHELVES

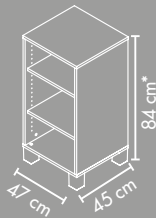
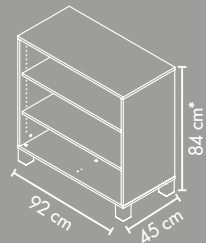
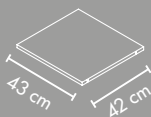
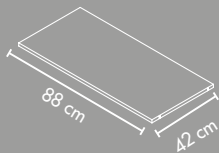

ACCESORIES



MODULES

*Height without legs or castors.

- in case of legs you should add 10 cm
- in case of castors you should add 10 cm

MOBILE UNIT

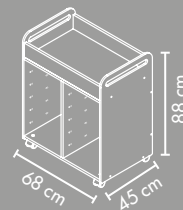

HANGING UNITS

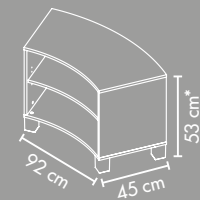
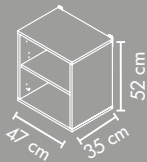
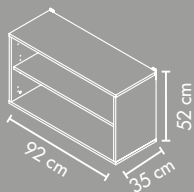

CORNER SHELVING UNITS

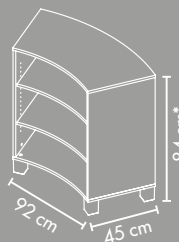

MAXI UNIT

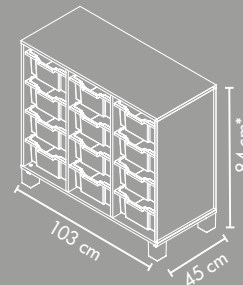

FEATURES

laminated body in birch finish



lockable glass door

adjustable shelf height

plastic trays are available in 8 colours: orange, grey, green, white, yellow, marine, pink and lime



fronts and handles in 5 colours: beige, orange, green, white and grey. Drawers with roller runners with a slide end lock



leg sets (in 3 colours) and lockable castors (sold separately)







doors in five colours with or without a lock

SMALL CABINETS







with shelves

	NM1001	orange
	NM1002	green
	NM1003	birch
	NM1004	white
	NM1005	grey







with door & shelves

	NM1011	orange
	NM1012	green
	NM1013	birch
	NM1014	white
	NM1015	grey



with drawers

	NM1021	orange
	NM1022	green
	NM1023	birch
	NM1024	white
	NM1025	grey







HANGING CABINETS

- dim.: 47 x 35 x 52 cm; body colour; birch; 1 shelf;
- material: laminated particle board 18 mm







with shelf

	NM5001	orange
	NM5002	green
	NM5003	birch
	NM5004	white
	NM5005	grey







with door & shelf

	NM5011	orange
	NM5012	green
	NM5013	birch
	NM5014	white
	NM5015	grey

- dim.: 92 x 35 x 52 cm; body colour; birch; 1 shelf;
- material: laminated particle board 18 mm







with shelf

	NM6001	orange
	NM6002	green
	NM6003	birch
	NM6004	white
	NM6005	grey



with door & shelf

	NM6011	orange
	NM6012	green
	NM6013	birch
	NM6014	white
	NM6015	grey



MEDIUM CABINETS

Available in units with deep or shallow trays, with or without doors. Shelves always

the same colour as the doors and drawers.

• dim.: 92 x 45 x 94 cm (height with legs)



with shelves

	NM2001	orange
	NM2002	green
	NM2003	birch
	NM2004	white
	NM2005	grey

with shelves

	NM2051	orange
	NM2052	green
	NM2053	birch
	NM2054	white
	NM2055	grey

with shelves

	NM2061	orange
	NM2062	green
	NM2063	birch
	NM2064	white
	NM2065	grey

with trays, doors & shelves

	NM2061B	orange
	NM2062B	green
	NM2063B	birch
	NM2064B	white
	NM2065B	grey



birch cabinets always with orange trays



birch cabinets always with orange trays



with trays & shelves

	NM2061P	orange
	NM2062P	green
	NM2063P	birch
	NM2064P	white
	NM2065P	grey

with doors & shelves

	NM2081	orange
	NM2082	green
	NM2083	birch
	NM2084	white
	NM2085	grey

with trays, doors & shelves

	NM2081B	orange
	NM2082B	green
	NM2083B	birch
	NM2084B	white
	NM2085B	grey

with trays, doors & shelves

	NM2081P	orange
	NM2082P	green
	NM2083P	birch
	NM2084P	white
	NM2085P	grey



In all medium cabinets castors can be mounted available on page 123

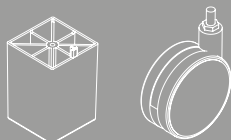

with doors & shelves

	NM2011	orange
	NM2012	green
	NM2013	birch
	NM2014	white
	NM2015	grey



with drawers

	NM2021	orange
	NM2022	green
	NM2023	birch
	NM2024	white
	NM2025	grey



with doors & shelves

	NM2041	orange
	NM2042	green
	NM2043	birch
	NM2044	white
	NM2045	grey



Space for 4 deep or 8 shallow trays

2 shallow trays yese up the same space as 1 deep.
The cabinets can hold various combinations trays.

- different types and colours



WIDE CABINETS



with trays

	NM4001B	orange
	NM4002B	green
	NM4004B	white
	NM4005B	grey



with trays

	NM4001P	orange
	NM4002P	green
	NM4004P	white
	NM4005P	grey

PLASTIC TRAYS

Plastic containers for Cubo, Fresh and Modern line furniture. They are perfect for implementing creative storage ideas. The wide selection of colours and sizes allows you to create unique arrangements which can be easily modified at any time. All containers are made of durable material.

- in the shape of a rectangle; material: plastic; intended use: storage



Plastic runners included in the set



3 pcs

	NS2356		NS2331
	NS2357		NS2330
	NS2358		NS2301
	NS2359		NS2300

MAXI

- dim.: 31 x 42 x 30 cm



1 pc

	NS2348		NS2352
	NS2349		NS2353
	NS2350		NS2355
	NS2351		NS2354

DEEP

- dim.: 31 x 42 x 16 cm



2 pcs

	NS2317		NS2315
	NS2320		NS2316
	NS2318		NS2327
	NS2319		NS2326



4 pcs

	NS2360		NS2333
	NS2361		NS2332
	NS2362		NS2303
	NS2363		NS2302



6 pcs

	NS2364		NS2337
	NS2365		NS2336
	NS2366		NS2307
	NS2367		NS2306

SHALLOW

- dim.: 31 x 42 x 7 cm



4 pcs

	NS2383		NS2381
	NS2386		NS2382
	NS2384		NS2397
	NS2385		NS2396



6 pcs

	NS2368		NS2335
	NS2369		NS2334
	NS2370		NS2305
	NS2371		NS2304



8 pcs

	NS2372		NS2339
	NS2373		NS2338
	NS2374		NS2309
	NS2375		NS2308



INSERTS

Inserts for plastic trays

- recommended for shallow trays
- polystyrene
- dim.: 40 x 275 x 388 mm
- thickness: 1,5 mm



- 4 compartments
NS1377



- 6 compartments
NS1376



- 8 compartments
NS1375

CORNER SHELVING UNITS

With these open-frame bookcases accessible from each side you will maximize the available floor space. Units can be combined into gently curved forms, thus adding a modern and creative flavour to the room. Available in two sizes and three colour versions of shelves.

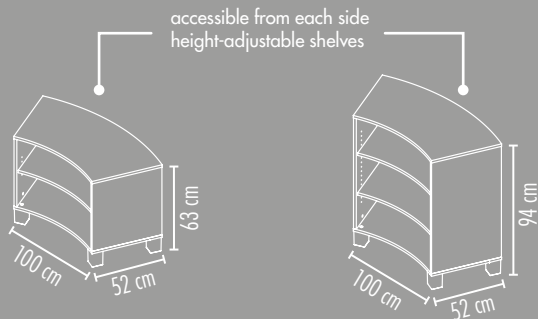











SMALL



BIG



	NM7071	orange
	NM7072	green
	NM7073	birch
	NM7074	white
	NM7075	grey

	NM7001	orange
	NM7002	green
	NM7003	birch
	NM7004	white
	NM7005	grey







SOFT SEATS

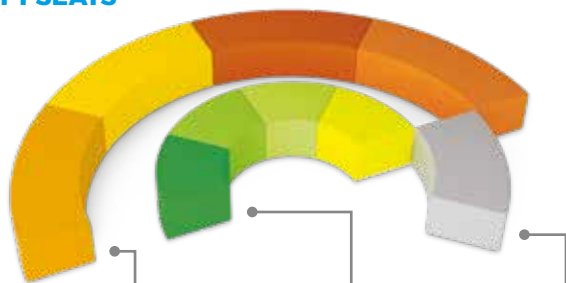

Foam 1 Sunny NS2180

- 4 pcs, 133 x 30 x 45 cm,
- total length: 528 cm

Foam 2 Green NS2179

- 4 pcs, 65,5 x 30 x 45 cm
- total length: 300 cm

Foam 3 Grey NS2181

- 1 pc: 100 x 30 x 45 cm

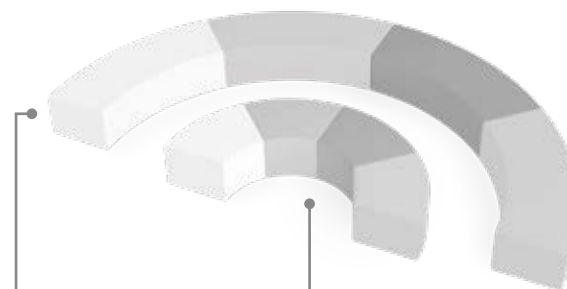

Foam 1 Black and White NS2259

- 4 pcs, 133 x 30 x 45 cm;
- total length: 528 cm

Foam 2 Black and White NS2260

- 4 pcs, 65,5 x 30 x 45 cm;
- total length: 300 cm



The set consists of: Foam 3 x2, Foam 2, NM7071 x2, NM7001



The set consists of: Foam 1, Foam 2, NM7072 x3, NM7002



The set consists of: Foam 1 x2, NM7072 x6, NM7002 x2



The set consists of: Foam 2 x2, NM7072 x2, NM70022 x6 + castors

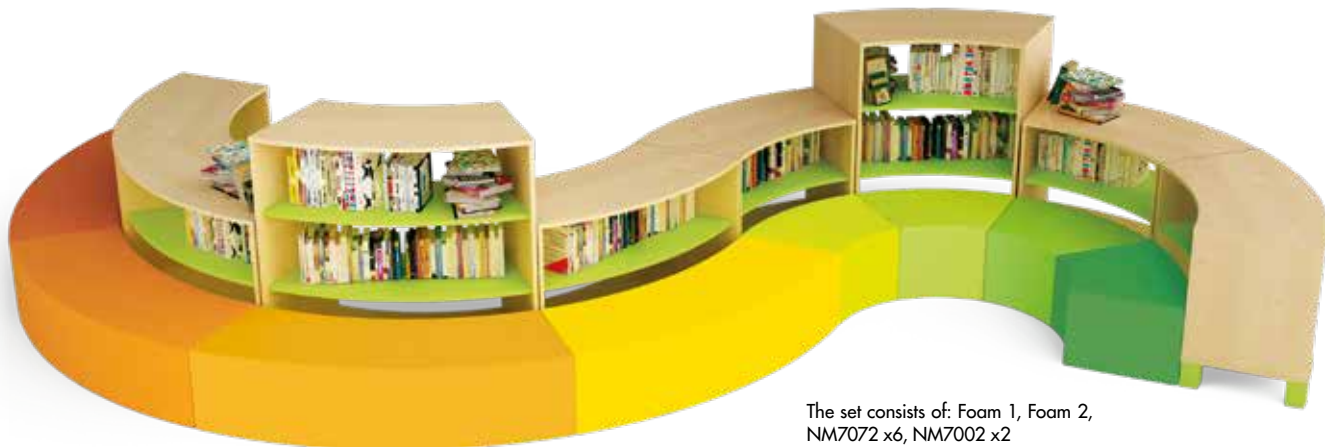

The set consists of: Foam 1, Foam 2, NM7072 x6, NM7002 x2

LIBRARY UNITS



Wall book display

• dim.: 92 x 17 x 105 cm

	NM9311	orange
	NM9312	green
	NM9314	white
	NM9315	grey

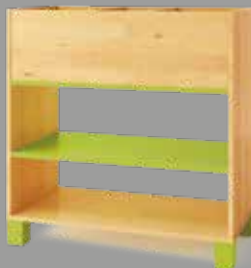

Bookcase

• dim.: 92 x 45 x 94 cm

	NM9201	orange
	NM9202	green
	NM9204	white
	NM9205	grey

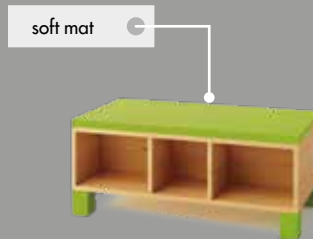

Bookcase

• dim.: 92 x 45 x 38 cm

	NM9401	orange
	NM9402	green
	NM9404	white
	NM9405	grey



Book Display

• dim.: 92 x 45 x 116 cm

	NM9331	orange
	NM9332	green
	NM9334	white
	NM9335	grey



Double sided boo display

• dim.: 92 x 45 x 116 cm

	NM9321	orange
	NM9322	green
	NM9324	white
	NM9325	grey



Book Display
NM9110

• dim.: 92 x 45 x 116 cm



Container
NM9120

• dim.: 86 x 45 x 33 cm

FRESH SNAKE

An element intended to enrich the bookcase series Fresh. The coloured poufs will make great seats for children to relax while listening to a story or reading a favourite book. The set of nine soft poufs can be used as a decoration in each room. The elements can also be joined together as puzzle pieces and so inspire children to play creatively in a playgroup or at school. All the elements are ergonomic and easy for children to carry around and arrange as they please, and they are safe thanks to no sharp edging. The cover is nice to the touch and easy to clean.

- particular elements can form a pouf around a box to match the bookcase Fresh (NM9500);
- it is possible to buy only four elements with which to form a cube (NM0010), a circle (NM0020) or an oval (NM0015)

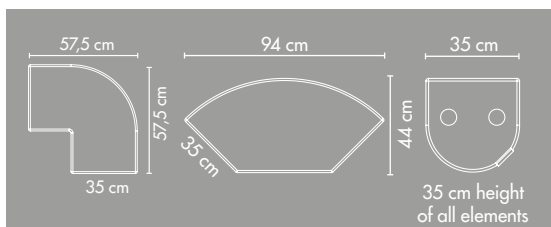

**Pouf – Oval
NM0015**

- 2 pcs, 58 x 58 x 35 cm in blue and green;
- 2 pcs, 67 x 67 x 35 cm in orange and green



**Pouf - Cube
NM0010**

- 4 pcs, 58 x 58 x 35 cm in orange, blue, green and red



**Pouf – Circle
NM0020**

- 4 pcs dim.: 67 x 67 x 35 cm in orange, blue, green and red



**Bookcase
NM9500**

- dim.: 45 x 45 x 49 cm

**Pouf – Snake's Head
NM0001**

- 1 pc dim.: 35 x 35 x 35 cm in yellow

**Foam seats – Snake
NM0100**

- 4 shapes 58 x 58 x 35 cm in orange, blue, green and red;
- 4 shapes 67 x 67 x 35 cm in blue, green and red;
- snake's head 35 x 35 x 35 cm in yellow



NM0020 + NS9500



NM0010 + NS9500

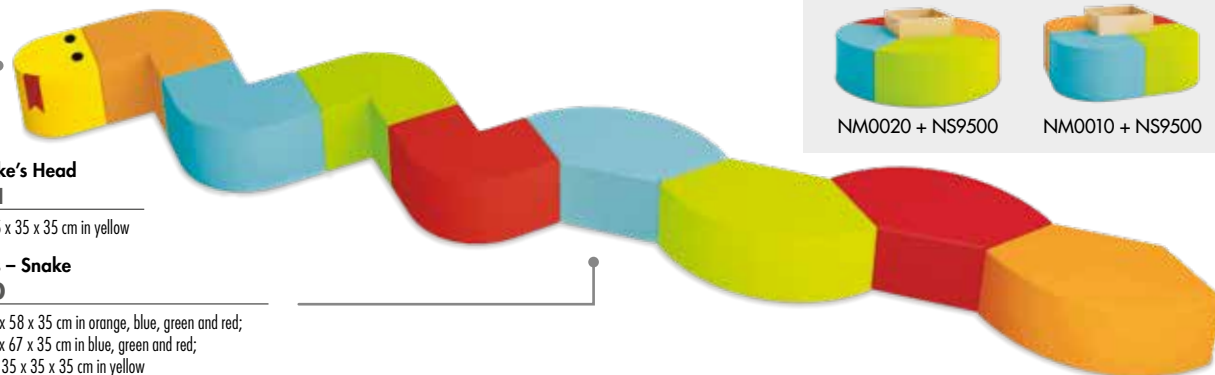

TALL CABINETS

Tall cabinets are a good storage place for educational aids or documents. All things that you want to keep safe yet handy should go into cabinets and drawers. Books are most handy on open shelves and aids will look their best behind glass lockable doors. With height-adjustable shelves you can make the most of the cabinet space. Things intended to be accessible to all are best placed on open shelves. Those used under the supervision of a teacher should be locked behind a glass door.

dim.: 92 x 45 x 176 cm (height with legs)



height-adjustable shelves



with shelves

	NM3001	orange
	NM3002	green
	NM3003	birch
	NM3004	white
	NM3005	grey



shelves always the same colour as the doors and drawers



glass lockable doors



with shelves & glass doors

	NM3301	orange
	NM3302	green
	NM3303	birch
	NM3304	white
	NM3305	grey



with shelves & double glass doors

	NM3331	orange
	NM3332	green
	NM3333	birch
	NM3334	white
	NM3335	grey



with drawers & shelves

	NM3021	orange
	NM3022	green
	NM3023	birch
	NM3024	white
	NM3025	grey



with drawers & glass doors

	NM3321	orange
	NM3322	green
	NM3323	birch
	NM3324	white
	NM3325	grey



with doors & shelves

with doors & shelves

with drawers,
doors & shelves

with shelves,
doors & glass doors

	NM3011	orange
	NM3012	green
	NM3013	birch
	NM3014	white
	NM3015	grey

	NM3111	orange
	NM3112	green
	NM3113	birch
	NM3114	white
	NM3115	grey

	NM3121	orange
	NM3122	green
	NM3123	birch
	NM3124	white
	NM3125	grey

	NM3311	orange
	NM3312	green
	NM3313	birch
	NM3314	white
	NM3315	grey

Version with lockable doors

Version with lockable doors

Version with lockable doors

Version with lockable doors

		NM3041	orange
		NM3042	green
		NM3043	birch
		NM3044	white
		NM3045	grey

		NM3441	orange
		NM3442	green
		NM3443	birch
		NM3444	white
		NM3445	grey

		NM3421	orange
		NM3422	green
		NM3423	birch
		NM3424	white
		NM3425	grey

		NM3341	orange
		NM3342	green
		NM3343	birch
		NM3344	white
		NM3345	grey



ACCESORIES

LEGS AND CASTORS



Castors
NJ0904

- 4 pcs, 2 with brakes;
- H 10 cm



Legs

- 4 pcs, dim.: 7 x 7 x 10 cm

	NJ0901	orange
	NJ0902	green
	NJ0903	birch



DOORS

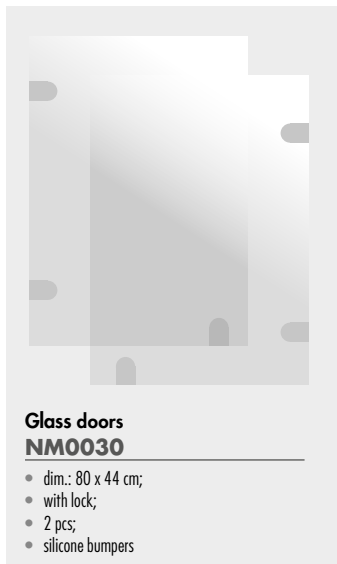

Glass doors
NM0030

- dim.: 80 x 44 cm;
- with lock;
- 2 pcs;
- silicone bumpers



SHELVES



Small shelves

- dim.: 43 x 42 cm, 2 pcs

	NM1201	orange
	NM1202	green
	NM1203	birch
	NM1204	grey
	NM1205	white



Big shelves

- dim.: 88 x 42 cm, 2 pcs

	NM2201	orange
	NM2202	green
	NM2203	birch
	NM2204	grey
	NM2205	white

height-adjustable shelves

Sold in 2 pcs same color







PRIMA

The central theme of the economy series Prima are muted colours and a wealth of combinations. Its formal minimalism and functionality make it a universal set of furniture, ideal for a classroom, teachers' room or the head's office.

The spacious cubby holes will accommodate educational aids, ring binders, books and

class registers. The open shelves are intended for the handiest objects and documents. The lockable units will be useful for important documents or aids with restricted access.

- one colour of the frame: birch or beech;
- two door versions: laminated board and glass - both lockable;
- ready-made sets available as seen;
- cabinet for registers;
- dimensions: 90 x 40 x 190 cm

TECHNICAL SPECIFICATION:

BODY:

board: chipboard
thickness: 18 mm
colour: birch/beech



base: board

SHELVES:

board: chipboard
thickness: 18 mm
colour: birch/beech



ADD-ON FOR REGISTERS:

board: MDF/HDF
surface: smooth
colour: white



DOORS:

type: opened
board: chipboard
thickness: 18 mm
surface: smooth
colour: birch/beech



type of handle: plastic
handle

lock: yes

board: glass
thickness: 6 mm
surface: smooth

type of handle: metal
handle

lock: yes

PRIMA FURNITURE

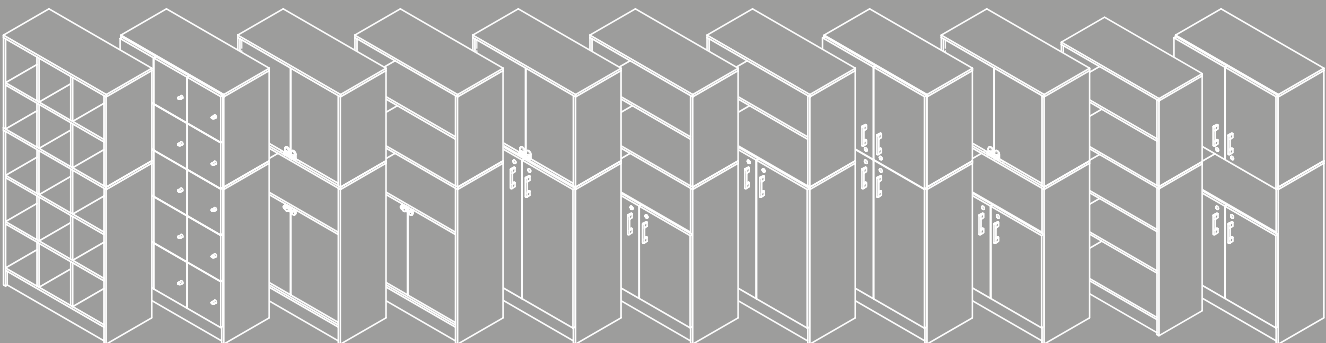
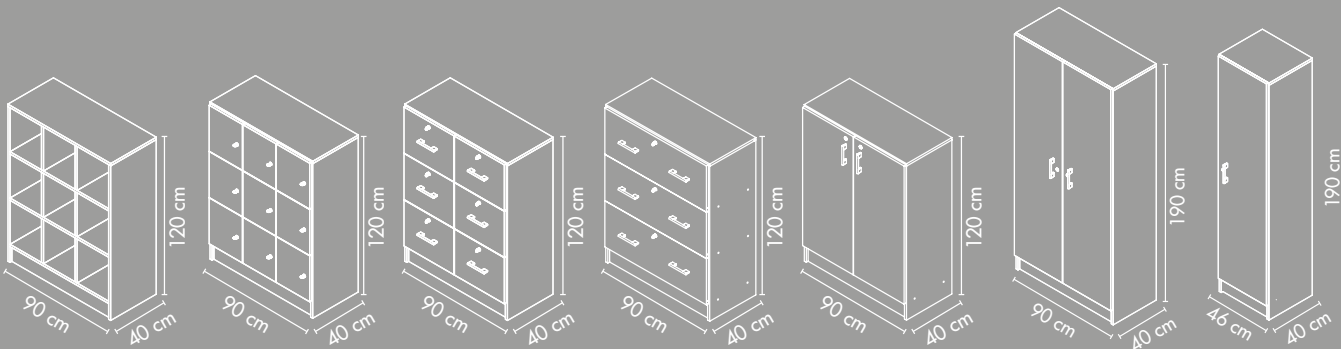
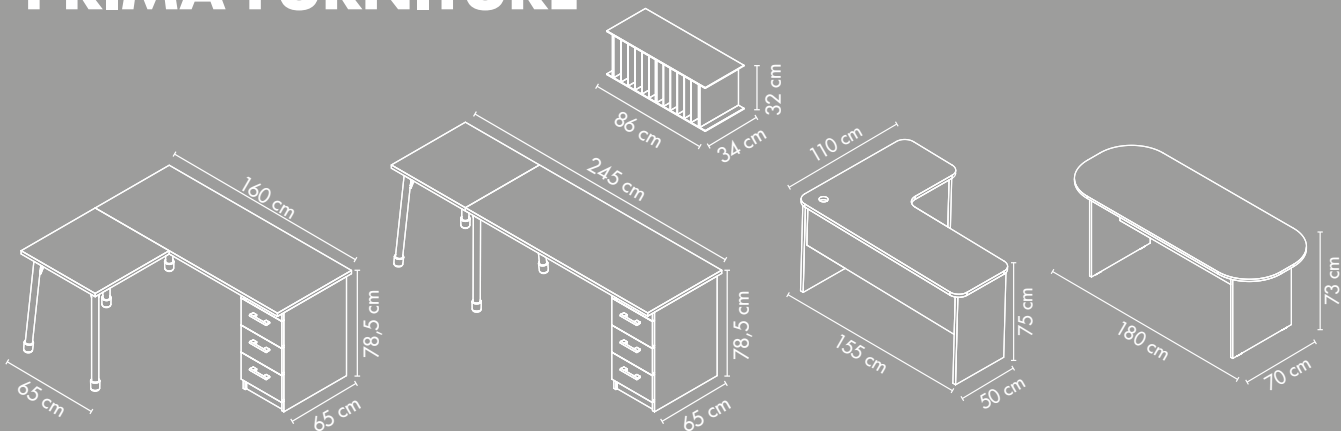

PRIMA

PRIMA FEATURES



spacious module for registers and documents - 14 compartments; can be mounted in cabinets with doors

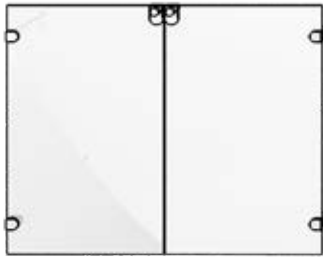

glass door can be mounted at the top or bottom of cabinet

H 190 cm

D 40 cm



90 cm

all doors with locks

smaller door can be mounted at the top or bottom of cabinet

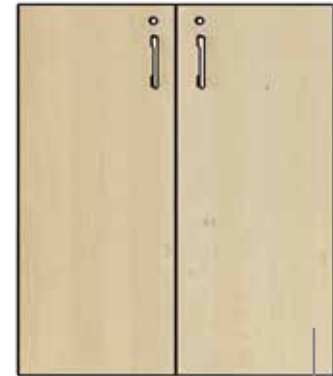
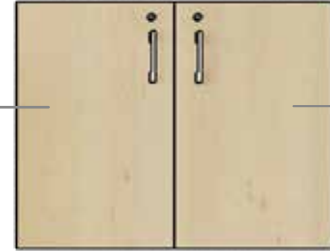

Large doors



LOCKER CABINETS

WITH DOORS



Storage locker 9 with doors

- dim.: 90 x 40 x 120 cm;
- 9 caches with locks, 28 x 39 x 33 cm each;
- material: laminated chipboard 18 mm

	birch	NB9331
	beech	NB9332
	birch-white	NB9333
	beech-white	NB9334



Storage locker 15 with doors

- dim.: 90 x 40 x 190 cm;
- 15 caches with locks, 28 x 39 x 33 cm each;
- material: laminated chipboard 18 mm

	birch	NB9351
	beech	NB9352
	birch-white	NB9353
	beech-white	NB9354

WITHOUT DOORS



Cubby hole unit 9

- dim.: 90 x 40 x 190 cm;
- 9 open cubby holes, 28 x 39 x 33 cm each;
- material: laminated chipboard 18 mm

	birch	NB9431
	beech	NB9432



Cubby hole unit 15

- dim.: 90 x 40 x 190 cm;
- 15 open cubby holes, 28 x 39 x 33 cm each;
- material: laminated chipboard 18 mm

	birch	NB9451
	beech	NB9452

Minimalist design combined with white colour and functionality makes the interior look original. Lockers with spacious shelves provide storage space for books while capacious cabinets can store teaching aids. Chests of drawers are perfect for keeping all necessary items in a given room. Single or double wardrobes provide space for clothes or personal belongings. The offer also includes desks with drawers and add-ons, which increase the surface of the tabletop. The calm white colour of the furniture can be a source of inspiration, it improves mood and creates a peaceful atmosphere. This series is well-suited for classrooms, science labs and teacher's room.

DOORS



Doors for the cubby hole unit 6

- 6 pcs, dim.: 35 x 29,2 cm, lock included;
- material: laminated chipboard 18 mm

	birch	NB0061
	beech	NB0062
	white	NB0063



Doors for the cubby hole unit 9

- 6 pcs, dim.: 35 x 29,2 cm, lock included;
- material: laminated chipboard 18 mm

	birch	NB0091
	beech	NB0092
	white	NB0093



Module for 14 class registers
NB3001

- 14 compartments; dim.: 86,5 x 34 x 33 cm



CHEST OF DRAWERS

A chest of drawer with ample space for documents, pupils' works or small teaching aids. The three or six drawers are equipped with convenient handles and locks for protection.

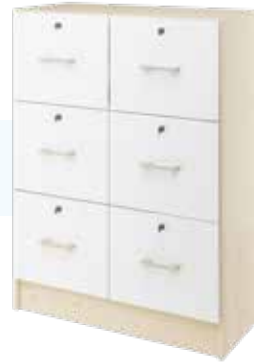

Wide chest of drawers

A chest of 3 drawers with wide drawers equipped with handles and locks. They can be used to safely store documents, assignments, or teaching aids.

- dim.: 90 x 40 x 120 cm;
- material: laminated chipboard, 18 mm;
- each drawer has got a lock



	birch	NB1201
	beech	NB1202
	birch-white	NB1203
	beech-white	NB1204

Chest of drawers

- dim.: 90 x 40 x 120 cm;
- drawer inside 36 x 33 x 26 cm

	birch	NB1101
	beech	NB1102
	birch-white	NB1103
	beech-white	NB1104

STORAGE



doors with a lock

3 shelves inside



Storage unit with doors

- dim.: 90 x 40 x 120 cm;
- 3 shelves;
- a pair of doors with a lock;
- material: laminated chipboard, 18 mm

	birch	NB1031
	beech	NB1032
	birch-white	NB1033
	beech-white	NB1034



TALL STORAGE

Minimalist design combined with white colour and functionality makes the interior look original. Lockers with spacious shelves provide storage space for books while capacious cabinets provide storage for teaching aids. Chests of drawers are perfect for keeping all necessary items in a given room. Single or double wardrobes provide space for clothes or personal belongings. The offer also includes desks with drawers and add-ons, which increase the surface of the tabletop. The calm white colour of the furniture can be a source of inspiration, it improves mood and creates a peaceful atmosphere. This series is well-suited for classrooms, science labs and teacher's room.



with shelves

- dim.: 90 x 190 x 40 cm

	birch	NB2001
	beech	NB2002



with shelves and wooden doors

- dim.: 90 x 190 x 40 cm

	birch	NB2011
	beech	NB2012
	birch-white	NB2013
	beech-white	NB2014



with large wooden doors

- dim.: 90 x 190 x 40 cm

	birch	NB2031
	beech	NB2032
	birch-white	NB2033
	beech-white	NB2034



with two pairs of doors and a shelf

- dim.: 90 x 190 x 40 cm

	birch	NB2111
	beech	NB2112
	birch-white	NB2113
	beech-white	NB2114



with two pairs of doors and shelves

- dim.: 90 x 190 x 40 cm

	birch	NB2131
	beech	NB2132
	birch-white	NB2133
	beech-white	NB2134



WITH GLASS DOORS



with shelves and glass doors

- dim.: 90 x 190 x 40 cm

	birch	NB2021
	beech	NB2022



with two pairs of glass doors and a shelf

- dim.: 90 x 190 x 40 cm

	birch	NB2221
	beech	NB2222



with a pair of doors, pair of glass doors and a shelf

- dim.: 90 x 190 x 40 cm

	birch	NB2211
	beech	NB2212
	birch-white	NB2213
	beech-white	NB2214



with a pair of doors and a pair of glass doors

- dim.: 90 x 190 x 40 cm

	birch	NB2231
	beech	NB2232
	birch-white	NB2233
	beech-white	NB2234

TALL STORAGE FOR MAPS

MAP STORAGE CABINET

Map storage cabinets complete the Prima furniture line. They provide functional storage space for maps and protect them from accidental damage. Thanks to the presented furniture pieces, it is possible to create a classroom which caters to the needs of students and teachers.

- dim.: 90 x 40 x 190,5 cm, with 4 niches;
- type: standalone;
- it is made of 18 mm thick chipboard in birch colour;
- the cabinet on a socle with 3 shelves, dim.: 86,5 x 38,6 cm, made of 18 mm thick chipboard / MDF board in in white/birch colour;
- four doors, dim.: 44,6 x 105,5 / 70 cm, made of 18 mm thick white chipboard;
- smooth surface;
- plastic grey handle;
- doors with a lock;
- storage space for 12 maps



storage space for 12 maps



	birch	NB2901
	beech	NB2902
	birch-white	NB2903
	beech-white	NB2904





WARDROBE



Small Wardrobe

• dim.: 46 x 40 x 190 cm

	birch	NB4041
	beech	NB4042



	birch-white	NB4043
	beech-white	NB4044



Large Wardrobe

• dim.: 90 x 40 x 190 cm

	birch	NB3041
	beech	NB3042

	birch-white	NB3043
	beech-white	NB3044





CONFERENCE TABLE



Conference table

- dim.: 70 x 180 x 73 cm

	birch	NB5001
	beech	NB5002







DESK



Prima desk right



- dim.: 155 x 110 x 75 cm

	birch	NB6201
	beech	NB6202



Prima desk left

- dim.: 155 x 110 x 75 cm

	birch	NB6101
	beech	NB6102

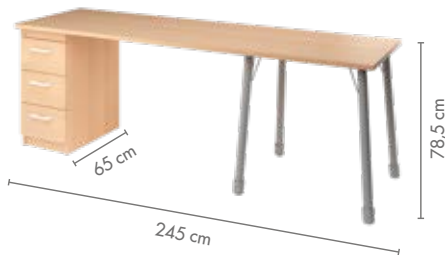



Prima desk with drawer

Big desk offering several options of assembly depending on the needs and room possibilities. It has 3 drawers closed with a central lock and an add-on which allows you to increase the work space.

- dim.: 160 x 65 x 78,5 cm;
- extension: 65 x 65 x 78,5 cm;
- drawer inside: 26 x 40 x 16 cm;
- material 18 and 25 mm particleboard;
- metal legs; requires assembly

	birch	NB6902
	beech	NB6901

	birch-white	NB6903
	beech-white	NB6904

MOBILE CABINETS

TROLLEY

Plastic trays available on page 92



Experiments require a lot of accessories that should be at hand and all of them can be stored inside this piece of furniture thanks to removable drawers. It will make delivering the instruments to the test stand safe and convenient. All it takes is to grab the handles and move the stroller to the desired location. It has enough space for 6 big or 12 small containers (sold separately).

- meas. dim.: 68,5 x 45 x 88 cm; 4 wheels with lock;
- material: grey or white MDF board, 12 mm thick



White
NM4034



Grey
NM4035



MULTIFUNCTIONAL MOBILE STAND

Universal stand for keeping rolled up vertical teaching aids, e.x.maps, boards or paper rolls. Equipped with wheels which are helpfull in moving the stand with it's content.

- dim.: 72 x 65 x 84 cm;
- material: 18 mm furniture board in birch colour, 12 mm MDF board in white/green colour, white/green wire;
- 4 wheels

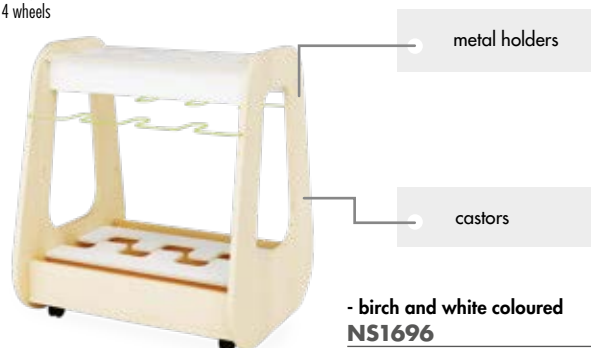



CLASSICAL monocolour

A proven and recognized line of furniture. It is very functional and allows unlimited combinations of colour arrangements, as well as a large display area. The containers, drawers and boxes help children to sort their school utensils and keep them tidy. Arranging a safe and comfortable interior is easier thanks to the wide variety of units and accessories. Decorative boards. The colourful boards will enliven every nursery classroom. The variety of colours and shapes stimulates children's imagination and encourages them to play on the surface of the furniture. Thanks

to their construction, cardboard trays hold a weight of up to 42 kgs, while remaining light and safe for children. Cardboard and wooden trays, which come in various colours, are aesthetic and very durable. Their dimensions fit the Classical series. All the elements are sold separately.

- five heights:
54, 74, 93, 112, 131 cm

Types of units available:

- with trays,
- with shelves,
- with trays and containers,
- with shelves and containers,
- with shelves and trays,

- with shelves + trays and containers,
- with compartments,
- with compartments and containers,
- corner and inside corner,
- tall storage units,
- bookcases

Extras (sold separately):

- doors,
- decorative boards,
- containers,
- shallow and deep wooden trays – 4 colours,
- shallow and deep cardboard trays – 4 colours,
- EKO shallow and deep cardboard trays,
- for trays, only we recommend NS0716 runners,
- the arrangements shown are only examples

BODY:

board: chipboard
thickness: 18 mm
colour: beech



base: board

SHELVES:

board: chipboard
thickness: 18 mm
colour: beech



height adjustment: no

board: HDF
thickness: 3,2 mm
colour: white



height adjustment: yes

DOORS:

type: opened
board: MDF
thickness: 12 mm

surface: smooth
colour:



type of handle: cutout
lock: yes

CONTAINERS:

board: chipboard/MDF
surface: smooth
frame colour: birch, beech



front colour:



DRAWERS:

material: beech, wood and plywood
colour:



material: cardboard
colour:



APPLICATIONS:

board: MDF
thickness: 12 mm
surface: milling
colour:



S

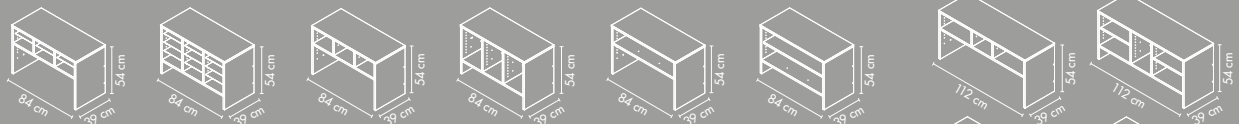

M

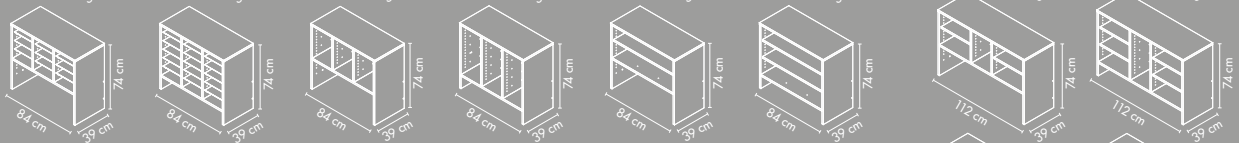

L

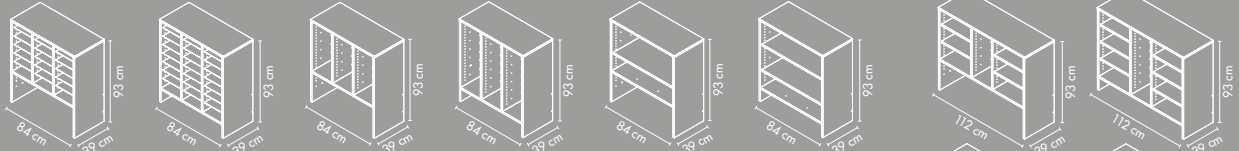

X

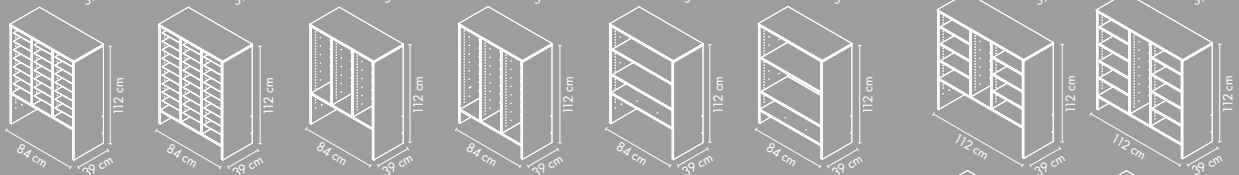

XL

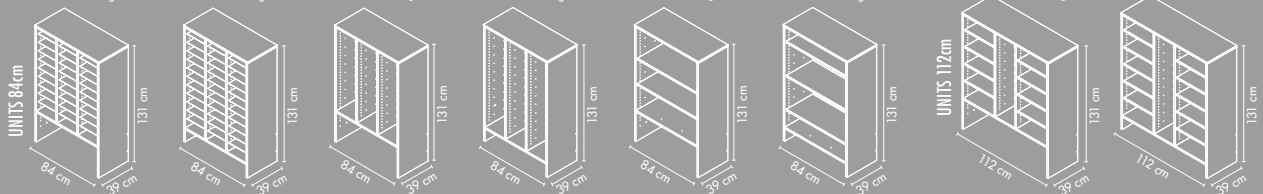

CLASSICAL SERIES FURNITURE

S

L

M

X

XL

CORNER UNITS

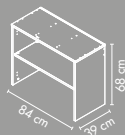

TALL SHELVING UNITS AND ADD-ON

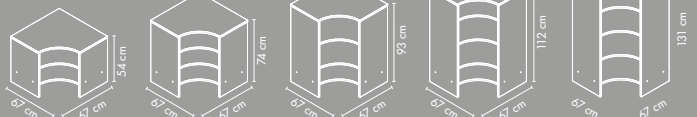

CORNER UNITS

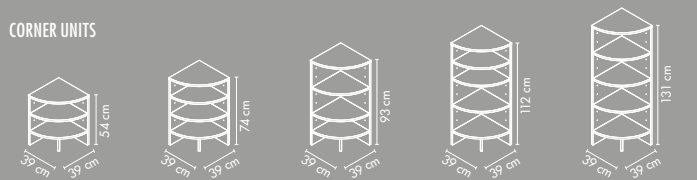
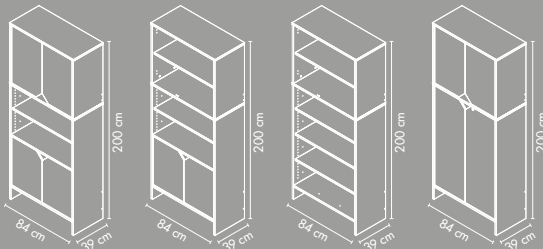

FEATURES

CLASSICAL monocolour

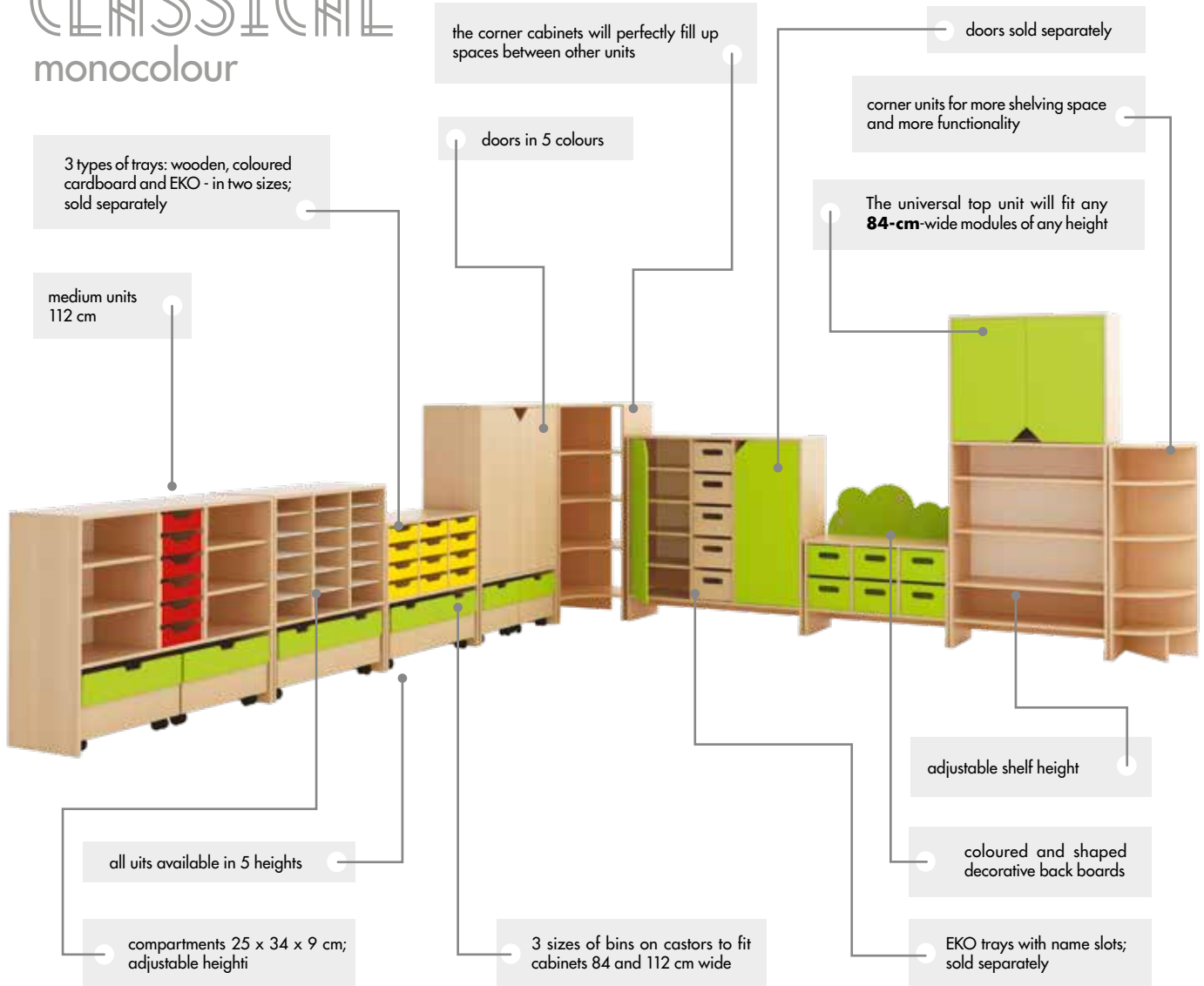

CLASSICAL

MONOCOLOUR READY FURNITURE

The Classic collection has been redesigned to keep up with modern trends. The new edition of this furniture line, combined with containers made of wood and cardboard in MONOCOLOUR, gives you the freedom to arrange any interior according to your needs. Thanks to the improved design, the Classic collection offers practical, high-quality furniture with a timeless and elegant form.



STORAGE UNITS 84 WITH CARDBOARD AND WOODEN TRAYS



* Cabinets sold without containers, choose for these models in the next pages which type and colors of containers you prefer.



WITH SHALLOW TRAYS



S		M		L		X		XL	
Cardboard	Wooden	Cardboard	Wooden	Cardboard	Wooden	Cardboard	Wooden	Cardboard	Wooden
NW0701-E7	NW0701-G7	NW0702-E7	NW0702-G7	NW0703-E7	NW0703-G7	NW0704-E7	NW0704-G7	NW0705-E7	NW0705-G7
NW0701-E1	NW0701-G1	NW0702-E1	NW0702-G1	NW0703-E1	NW0703-G1	NW0704-E1	NW0704-G1	NW0705-E1	NW0705-G1
NW0701-E2	NW0701-G2	NW0702-E2	NW0702-G2	NW0703-E2	NW0703-G2	NW0704-E2	NW0704-G2	NW0705-E2	NW0705-G2
NW0701-E3	NW0701-G3	NW0702-E3	NW0702-G3	NW0703-E3	NW0703-G3	NW0704-E3	NW0704-G3	NW0705-E3	NW0705-G3
NW0701-E4	NW0701-G4	NW0702-E4	NW0702-G4	NW0703-E4	NW0703-G4	NW0704-E4	NW0704-G4	NW0705-E4	NW0705-G4

WITH DEEP TRAYS



S		M		L		X		XL	
Cardboard	Wooden	Cardboard	Wooden	Cardboard	Wooden	Cardboard	Wooden	Cardboard	Wooden
NW0701-F7	NW0701-H7	NW0702-F7	NW0702-H7	NW0703-F7	NW0703-H7	NW0704-F7	NW0704-H7	NW0705-F7	NW0705-H7
NW0701-F1	NW0701-H1	NW0702-F1	NW0702-H1	NW0703-F1	NW0703-H1	NW0704-F1	NW0704-H1	NW0705-F1	NW0705-H1
NW0701-F2	NW0701-H2	NW0702-F2	NW0702-H2	NW0703-F2	NW0703-H2	NW0704-F2	NW0704-H2	NW0705-F2	NW0705-H2
NW0701-F3	NW0701-H3	NW0702-F3	NW0702-H3	NW0703-F3	NW0703-H3	NW0704-F3	NW0704-H3	NW0705-F3	NW0705-H3
NW0701-F4	NW0701-H4	NW0702-F4	NW0702-H4	NW0703-F4	NW0703-H4	NW0704-F4	NW0704-H4	NW0705-F4	NW0705-H4



STORAGE UNITS 84 WITH CARDBOARD AND WOODEN TRAYS + CONTAINERS ON CASTERS



* Cabinets sold without containers, choose for these models in the next pages which type and colors of containers you prefer.



WITH SHALLOW TRAYS



S		M		L		X		XL	
Cardboard	Wooden	Cardboard	Wooden	Cardboard	Wooden	Cardboard	Wooden	Cardboard	Wooden
NW0801-I7	NW0801-K7	NW0802-I7	NW0802-K7	NW0803-I7	NW0803-K7	NW0804-I7	NW0804-K7	NW0805-I7	NW0805-K7
NW0801-I1	NW0801-K1	NW0802-I1	NW0802-K1	NW0803-I1	NW0803-K1	NW0804-I1	NW0804-K1	NW0805-I1	NW0805-K1
NW0801-I2	NW0801-K2	NW0802-I2	NW0802-K2	NW0803-I2	NW0803-K2	NW0804-I2	NW0804-K2	NW0805-I2	NW0805-K2
NW0801-I3	NW0801-K3	NW0802-I3	NW0802-K3	NW0803-I3	NW0803-K3	NW0804-I3	NW0804-K3	NW0805-I3	NW0805-K3
NW0801-I4	NW0801-K4	NW0802-I4	NW0802-K4	NW0803-I4	NW0803-K4	NW0804-I4	NW0804-K4	NW0805-I4	NW0805-K4

WITH DEEP TRAYS



S		M		L		X		XL	
Cardboard	Wooden	Cardboard	Wooden	Cardboard	Wooden	Cardboard	Wooden	Cardboard	Wooden
NW0801-J7	NW0801-L7	NW0802-J7	NW0802-L7	NW0803-J7	NW0803-L7	NW0804-J7	NW0804-L7	NW0805-J7	NW0805-L7
NW0801-J1	NW0801-L1	NW0802-J1	NW0802-L1	NW0803-J1	NW0803-L1	NW0804-J1	NW0804-L1	NW0805-J1	NW0805-L1
NW0801-J2	NW0801-L2	NW0802-J2	NW0802-L2	NW0803-J2	NW0803-L2	NW0804-J2	NW0804-L2	NW0805-J2	NW0805-L2
NW0801-J3	NW0801-L3	NW0802-J3	NW0802-L3	NW0803-J3	NW0803-L3	NW0804-J3	NW0804-L3	NW0805-J3	NW0805-L3
NW0801-J4	NW0801-L4	NW0802-J4	NW0802-L4	NW0803-J4	NW0803-L4	NW0804-J4	NW0804-L4	NW0805-J4	NW0805-L4

STORAGE UNITS 84 WITH SHELVES



* Cabinets sold without containers, choose for these models in the next pages which type and colors of containers you prefer.



WITH SHELVES AND DOORS



S	M	L	X	XL
NW0711-B7	NW0712-B7	NW0713-B7	NW0714-B7	NW0715-B7
NW0711-B1	NW0712-B1	NW0713-B1	NW0714-B1	NW0715-B1
NW0711-B2	NW0712-B2	NW0713-B2	NW0714-B2	NW0715-B2
NW0711-B3	NW0712-B3	NW0713-B3	NW0714-B3	NW0715-B3
NW0711-B4	NW0712-B4	NW0713-B4	NW0714-B4	NW0715-B4

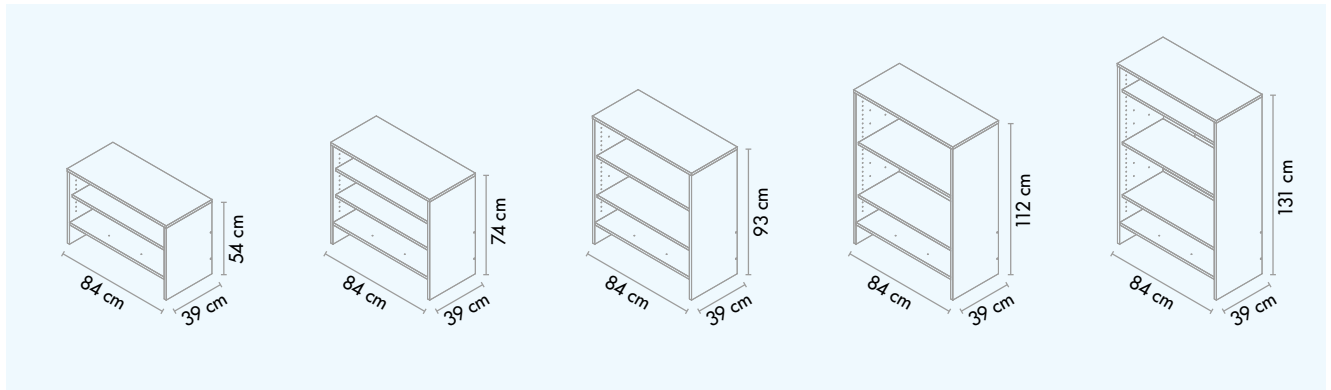

STORAGE UNITS 84 WITH SHELVES FOR CONTAINERS



* Cabinets sold without containers, choose for these models in the next pages which type and colors of containers you prefer.



WITH SHELVES AND CONTAINERS

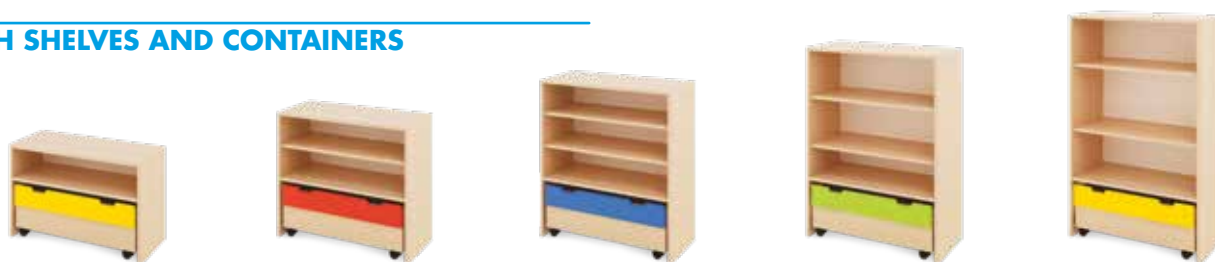

S	M	L	X	XL
NW0811-C7	NW0812-C7	NW0813-C7	NW0814-C7	NW0815-C7
NW0811-C1	NW0812-C1	NW0813-C1	NW0814-C1	NW0815-C1
NW0811-C2	NW0812-C2	NW0813-C2	NW0814-C2	NW0815-C2
NW0811-C3	NW0812-C3	NW0813-C3	NW0814-C3	NW0815-C3
NW0811-C4	NW0812-C4	NW0813-C4	NW0814-C4	NW0815-C4

WITH SHELVES, DOORS AND CONTAINERS



M	L	X	XL
NW0812-D7	NW0813-D7	NW0814-D7	NW0815-D7
NW0812-D1	NW0813-D1	NW0814-D1	NW0815-D1
NW0812-D2	NW0813-D2	NW0814-D2	NW0815-D2
NW0812-D3	NW0813-D3	NW0814-D3	NW0815-D3
NW0812-D4	NW0813-D4	NW0814-D4	NW0815-D4



STORAGE UNITS 84 WITH COMPARTMENTS



S

NW0731



M

NW0732



L

NW0733



X

NW0734



XL

NW0735

STORAGE UNITS 84 WITH COMPARTMENTS FOR CONTAINERS

* Cabinets sold without containers, choose for these models in the next pages which type and colors of containers you prefer.



S

NW0831 *



M

NW0832 *



L

NW0833 *



X

NW0834 *



XL

NW0835 *

STORAGE UNITS 84 WITH COMPARTMENTS AND CONTAINERS



S

NW0831-N1



M

NW0832-N1



L

NW0833-N1



X

NW0834-N1



XL

NW0835-N1

NW0831-N2

NW0832-N2

NW0833-N2

NW0834-N2

NW0835-N2

NW0831-N3

NW0832-N3

NW0833-N3

NW0834-N3

NW0835-N3

NW0831-N4

NW0832-N4

NW0833-N4

NW0834-N4

NW0835-N4

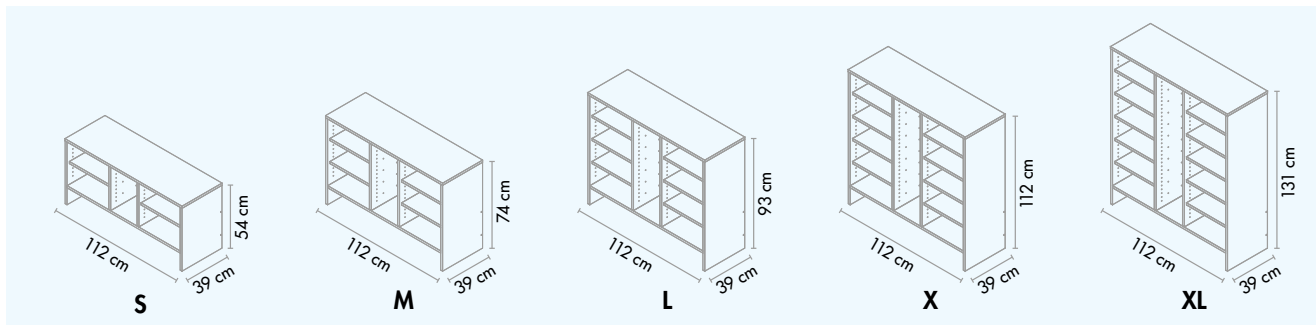

WITH DEEP TRAYS



S		M		L		X		XL	
Cardboard	Wooden	Cardboard	Wooden	Cardboard	Wooden	Cardboard	Wooden	Cardboard	Wooden
NW0721-XF7	NW0721-XH7	NW0722-XF7	NW0722-XH7	NW0723-XF7	NW0723-XH7	NW0724-XF7	NW0724-XH7	NW0725-XF7	NW0725-XH7
NW0721-XF1	NW0721-XH1	NW0722-XF1	NW0722-XH1	NW0723-XF1	NW0723-XH1	NW0724-XF1	NW0724-XH1	NW0725-XF1	NW0725-XH1
NW0721-XF2	NW0721-XH2	NW0722-XF2	NW0722-XH2	NW0723-XF2	NW0723-XH2	NW0724-XF2	NW0724-XH2	NW0725-XF2	NW0725-XH2
NW0721-XF3	NW0721-XH3	NW0722-XF3	NW0722-XH3	NW0723-XF3	NW0723-XH3	NW0724-XF3	NW0724-XH3	NW0725-XF3	NW0725-XH3
NW0721-XF4	NW0721-XH4	NW0722-XF4	NW0722-XH4	NW0723-XF4	NW0723-XH4	NW0724-XF4	NW0724-XH4	NW0725-XF4	NW0725-XH4

WITH DEEP TRAYS AND DOORS



S		M		L		X		XL	
Cardboard	Wooden	Cardboard	Wooden	Cardboard	Wooden	Cardboard	Wooden	Cardboard	Wooden
NW0721-ZF7	NW0721-ZH7	NW0722-ZF7	NW0722-ZH7	NW0723-ZF7	NW0723-ZH7	NW0724-ZF7	NW0724-ZH7	NW0725-ZF7	NW0725-ZH7
NW0721-ZF1	NW0721-ZH1	NW0722-ZF1	NW0722-ZH1	NW0723-ZF1	NW0723-ZH1	NW0724-ZF1	NW0724-ZH1	NW0725-ZF1	NW0725-ZH1
NW0721-ZF2	NW0721-ZH2	NW0722-ZF2	NW0722-ZH2	NW0723-ZF2	NW0723-ZH2	NW0724-ZF2	NW0724-ZH2	NW0725-ZF2	NW0725-ZH2
NW0721-ZF3	NW0721-ZH3	NW0722-ZF3	NW0722-ZH3	NW0723-ZF3	NW0723-ZH3	NW0724-ZF3	NW0724-ZH3	NW0725-ZF3	NW0725-ZH3
NW0721-ZF4	NW0721-ZH4	NW0722-ZF4	NW0722-ZH4	NW0723-ZF4	NW0723-ZH4	NW0724-ZF4	NW0724-ZH4	NW0725-ZF4	NW0725-ZH4

STORAGE UNITS I12 WITH CARDBOARD AND WOODEN TRAYS



* Cabinets sold without containers, choose for these models in the next pages which type and colors of containers you prefer.



WITH SHALLOW TRAYS

S		M		L		X		XL	
Cardboard	Wooden	Cardboard	Wooden	Cardboard	Wooden	Cardboard	Wooden	Cardboard	Wooden
NW0721-XE7	NW0721-XG7	NW0722-XE7	NW0722-XG7	NW0723-XE7	NW0723-XG7	NW0724-XE7	NW0724-XG7	NW0725-XE7	NW0725-XG7
NW0721-XE1	NW0721-XG1	NW0722-XE1	NW0722-XG1	NW0723-XE1	NW0723-XG1	NW0724-XE1	NW0724-XG1	NW0725-XE1	NW0725-XG1
NW0721-XE2	NW0721-XG2	NW0722-XE2	NW0722-XG2	NW0723-XE2	NW0723-XG2	NW0724-XE2	NW0724-XG2	NW0725-XE2	NW0725-XG2
NW0721-XE3	NW0721-XG3	NW0722-XE3	NW0722-XG3	NW0723-XE3	NW0723-XG3	NW0724-XE3	NW0724-XG3	NW0725-XE3	NW0725-XG3
NW0721-XE4	NW0721-XG4	NW0722-XE4	NW0722-XG4	NW0723-XE4	NW0723-XG4	NW0724-XE4	NW0724-XG4	NW0725-XE4	NW0725-XG4

WITH SHALLOW TRAYS

S		M		L		X		XL	
Cardboard	Wooden	Cardboard	Wooden	Cardboard	Wooden	Cardboard	Wooden	Cardboard	Wooden
NW0721-ZE7	NW0721-ZG7	NW0722-ZE7	NW0722-ZG7	NW0723-ZE7	NW0723-ZG7	NW0724-ZE7	NW0724-ZG7	NW0725-ZE7	NW0725-ZG7
NW0721-ZE1	NW0721-ZG1	NW0722-ZE1	NW0722-ZG1	NW0723-ZE1	NW0723-ZG1	NW0724-ZE1	NW0724-ZG1	NW0725-ZE1	NW0725-ZG1
NW0721-ZE2	NW0721-ZG2	NW0722-ZE2	NW0722-ZG2	NW0723-ZE2	NW0723-ZG2	NW0724-ZE2	NW0724-ZG2	NW0725-ZE2	NW0725-ZG2
NW0721-ZE3	NW0721-ZG3	NW0722-ZE3	NW0722-ZG3	NW0723-ZE3	NW0723-ZG3	NW0724-ZE3	NW0724-ZG3	NW0725-ZE3	NW0725-ZG3
NW0721-ZE4	NW0721-ZG4	NW0722-ZE4	NW0722-ZG4	NW0723-ZE4	NW0723-ZG4	NW0724-ZE4	NW0724-ZG4	NW0725-ZE4	NW0725-ZG4

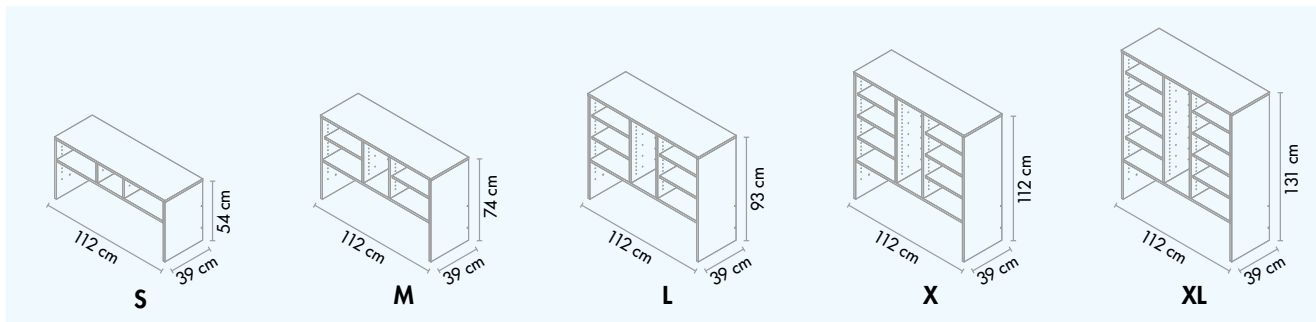

WITH DEEP TRAYS AND CONTAINERS

S		M		L		X		XL	
Cardboard	Wooden	Cardboard	Wooden	Cardboard	Wooden	Cardboard	Wooden	Cardboard	Wooden
NW0821-XJ7	NW0821-XL7	NW0822-XJ7	NW0822-XL7	NW0823-XJ7	NW0823-XL7	NW0824-XJ7	NW0824-XL7	NW0825-XJ7	NW0825-XL7
NW0821-XJ1	NW0821-XL1	NW0822-XJ1	NW0822-XL1	NW0823-XJ1	NW0823-XL1	NW0824-XJ1	NW0824-XL1	NW0825-XJ1	NW0825-XL1
NW0821-XJ2	NW0821-XL2	NW0822-XJ2	NW0822-XL2	NW0823-XJ2	NW0823-XL2	NW0824-XJ2	NW0824-XL2	NW0825-XJ2	NW0825-XL2
NW0821-XJ3	NW0821-XL3	NW0822-XJ3	NW0822-XL3	NW0823-XJ3	NW0823-XL3	NW0824-XJ3	NW0824-XL3	NW0825-XJ3	NW0825-XL3
NW0821-XJ4	NW0821-XL4	NW0822-XJ4	NW0822-XL4	NW0823-XJ4	NW0823-XL4	NW0824-XJ4	NW0824-XL4	NW0825-XJ4	NW0825-XL4

WITH DEEP TRAYS, DOORS AND CONTAINERS

M		L		X		XL	
Cardboard	Wooden	Cardboard	Wooden	Cardboard	Wooden	Cardboard	Wooden
NW0822-ZJ7	NW0822-ZL7	NW0823-ZJ7	NW0823-ZL7	NW0824-ZJ7	NW0824-ZL7	NW0825-ZJ7	NW0825-ZL7
NW0822-ZJ1	NW0822-ZL1	NW0823-ZJ1	NW0823-ZL1	NW0824-ZJ1	NW0824-ZL1	NW0825-ZJ1	NW0825-ZL1
NW0822-ZJ2	NW0822-ZL2	NW0823-ZJ2	NW0823-ZL2	NW0824-ZJ2	NW0824-ZL2	NW0825-ZJ2	NW0825-ZL2
NW0822-ZJ3	NW0822-ZL3	NW0823-ZJ3	NW0823-ZL3	NW0824-ZJ3	NW0824-ZL3	NW0825-ZJ3	NW0825-ZL3
NW0822-ZJ4	NW0822-ZL4	NW0823-ZJ4	NW0823-ZL4	NW0824-ZJ4	NW0824-ZL4	NW0825-ZJ4	NW0825-ZL4

STORAGE UNITS 112 WITH TRAYS AND CONTAINERS



* Cabinets sold without containers, choose for these models in the next pages which type and colors of containers you prefer.



WITH SHALLOW TRAYS AND CONTAINERS

S		M		L		X		XL	
Cardboard	Wooden	Cardboard	Wooden	Cardboard	Wooden	Cardboard	Wooden	Cardboard	Wooden
NW0821-X17	NW0821-XK7	NW0822-X17	NW0822-XK7	NW0823-X17	NW0823-XK7	NW0824-X17	NW0824-XK7	NW0825-X17	NW0825-XK7
NW0821-X11	NW0821-XK1	NW0822-X11	NW0822-XK1	NW0823-X11	NW0823-XK1	NW0824-X11	NW0824-XK1	NW0825-X11	NW0825-XK1
NW0821-X12	NW0821-XK2	NW0822-X12	NW0822-XK2	NW0823-X12	NW0823-XK2	NW0824-X12	NW0824-XK2	NW0825-X12	NW0825-XK2
NW0821-X13	NW0821-XK3	NW0822-X13	NW0822-XK3	NW0823-X13	NW0823-XK3	NW0824-X13	NW0824-XK3	NW0825-X13	NW0825-XK3
NW0821-X14	NW0821-XK4	NW0822-X14	NW0822-XK4	NW0823-X14	NW0823-XK4	NW0824-X14	NW0824-XK4	NW0825-X14	NW0825-XK4

WITH SHALLOW TRAYS, DOORS AND CONTAINERS

M		L		X		XL	
Cardboard	Wooden	Cardboard	Wooden	Cardboard	Wooden	Cardboard	Wooden
NW0822-Z17	NW0822-ZK7	NW0823-Z17	NW0823-ZK7	NW0824-Z17	NW0824-ZK7	NW0825-Z17	NW0825-ZK7
NW0822-Z11	NW0822-ZK1	NW0823-Z11	NW0823-ZK1	NW0824-Z11	NW0824-ZK1	NW0825-Z11	NW0825-ZK1
NW0822-Z12	NW0822-ZK2	NW0823-Z12	NW0823-ZK2	NW0824-Z12	NW0824-ZK2	NW0825-Z12	NW0825-ZK2
NW0822-Z13	NW0822-ZK3	NW0823-Z13	NW0823-ZK3	NW0824-Z13	NW0824-ZK3	NW0825-Z13	NW0825-ZK3
NW0822-Z14	NW0822-ZK4	NW0823-Z14	NW0823-ZK4	NW0824-Z14	NW0824-ZK4	NW0825-Z14	NW0825-ZK4

TALL STORAGE

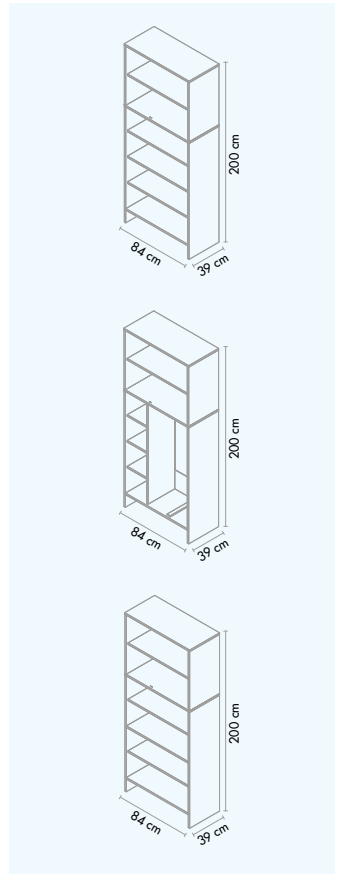
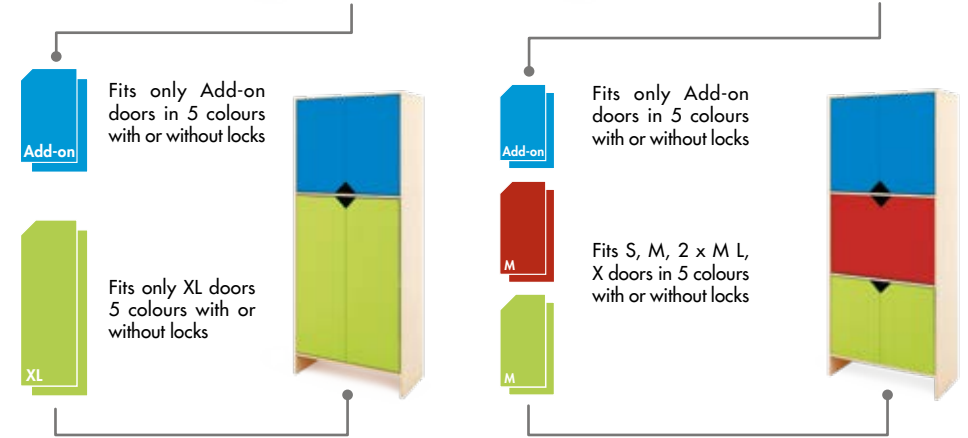

WITH DOORS XL

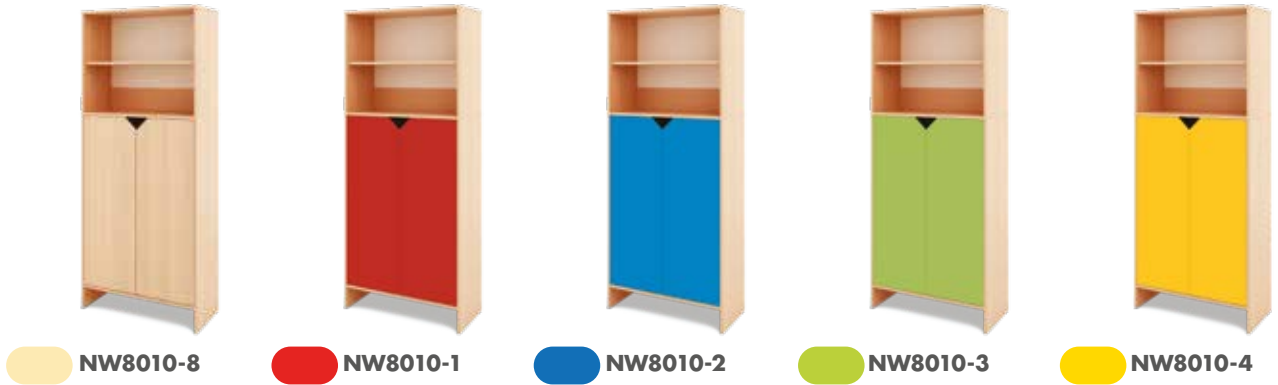

WITH DOORS ADD-ON AND XL



NW8020-8



NW8020-1



NW8020-2



NW8020-3



NW8020-4

WITH DOORS M



NW8021-8



NW8021-1



NW8021-2



NW8021-3



NW8021-4

WITH DOORS ADD-ON AND M



NW8022-8



NW8022-1



NW8022-2



NW8022-3



NW8022-4

ADD-ON

Each 84cm cabinet can be extended with this unit.

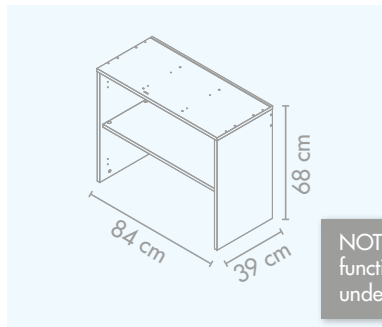

NOT A STANDALONE UNIT
functional only with a base unit underneath



Add-on NW0001

- dim.: 84 x 39,5 x 65,5 cm;
- doors sold separately

HOW DOES ADD-ONS WORK?



DOORS

sold in 2 pcs set

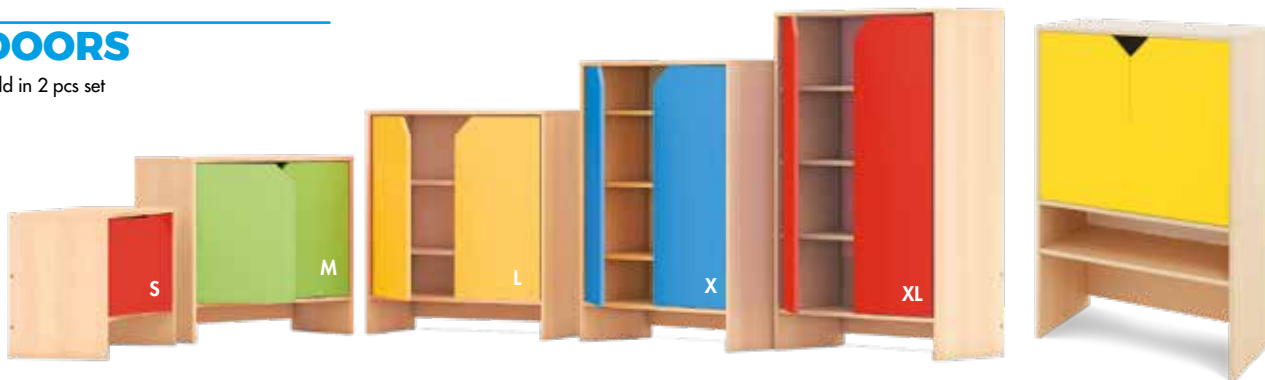

	S	M	L	X	XL	for add-on
with lock	40 x 36 cm	40 x 55 cm	40 x 75 cm	40 x 94 cm	40 x 113 cm	39,5 x 65,5 cm
	NW0411Z	NW0421Z	NW0431Z	NW0441Z	NW0451Z	NW0461Z
	NW0412Z	NW0422Z	NW0432Z	NW0442Z	NW0452Z	NW0462Z
	NW0413Z	NW0423Z	NW0433Z	NW0443Z	NW0453Z	NW0463Z
	NW0414Z	NW0424Z	NW0434Z	NW0444Z	NW0454Z	NW0464Z
	NW0521Z	NW0522Z	NW0523Z	NW0524Z	NW0525Z	NW0526Z

	S	M	L	X	XL	for add-on
without lock	40 x 36 cm	40 x 55 cm	40 x 75 cm	40 x 94 cm	40 x 113 cm	39,5 x 65,5 cm
	NW0411	NW0421	NW0431	NW0441	NW0451	NW0461
	NW0412	NW0422	NW0432	NW0442	NW0452	NW0462
	NW0413	NW0423	NW0433	NW0443	NW0453	NW0463
	NW0414	NW0424	NW0434	NW0444	NW0454	NW0464
	NW0521	NW0522	NW0523	NW0524	NW0525	NW0526





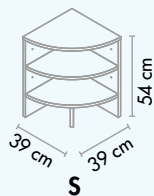

S

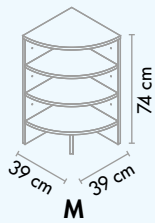

M

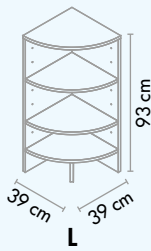

L

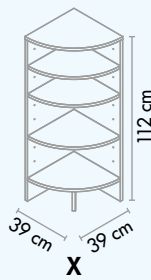

X

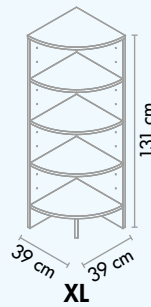

XL

INSIDE CORNER SHELVING UNIT



S

NW0761



M

NW0762



L

NW0763



X

NW0764



XL

NW0765

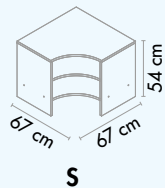

S

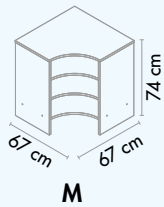

M

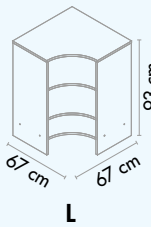

L

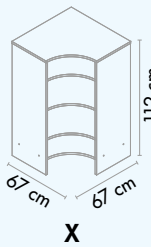

X

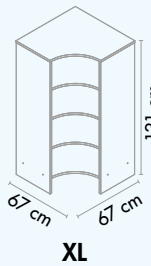

XL

CORNER SHELVING UNIT



S

NW0751



M

NW0752



L

NW0753



X

NW0754



XL

NW0755

CONTAINERS



Small container for 84 cm units
dim.: 35 x 35 x 30 cm

S

NW0631

NW0632

NW0633

NW0634



Medium container for 112 cm units
dim.: 53 x 35 x 30 cm

M

NW0621

NW0622

NW0623

NW0624



Large container for 84 cm units
dim.: 77 x 35 x 30 cm

L

NW0611

NW0612

NW0613

NW0614

RUNNERS



Runners
NS0716

- 12 pcs;
- L 29 cm



DECORATIVE BOARDS



Fence
NS8104

- W 84 cm



Tree
NS8107

- W 84 cm

HANGING SHELF



Hanging shelf
NS0556

- dim.: 60 x 32 x 50 cm;
- colour: beech



Sunflower. Decorative board
NS8109

- dim.: 60 x 34 cm

TRAYS

Trays available in colours:



WOODEN

- material: beech wood;
- requires assembly;
- small dim.: 25 x 35 x 8 cm;
- big dim.: 25 x 35 x 17 cm



Small 1 pc

	NS7931
	NS7932
	NS7933
	NS7934
	NS7930



Small 6 pcs

	MW06-01
	MW06-02
	MW06-03
	MW06-04
	MW06-07



Small 12 pcs

	MW12-01
	MW12-02
	MW12-03
	MW12-04
	MW12-07



Big 1 pc

	NS7911
	NS7912
	NS7913
	NS7914
	NS7910



Big 3 pcs

	DW03-01
	DW03-02
	DW03-03
	DW03-04
	DW03-07



Big 6 pcs

	DW06-01
	DW06-02
	DW06-03
	DW06-04
	DW06-07



Big 9 pcs

	DW09-01
	DW09-02
	DW09-03
	DW09-04
	DW09-07





CARDBOARD

- material: cardboard;
- requires assembly
- small dim.: 25 x 35 x 8 cm
- big dim.: 25 x 35 x 17 cm

MIX COLOUR

Small 12 pc



	NS1714

Big 8 pc



	NS1715

Big 8 pc



	NS0718
--	--------



MONOCOLOUR SETS



Small 6 pcs

	MK06-01
	MK06-02
	MK06-03
	MK06-04
	MK06-07



Small 12 pcs

	MK12-01
	MK12-02
	MK12-03
	MK12-04
	NS0717



Big 6 pcs

	DK06-01
	DK06-02
	DK06-03
	DK06-04
	DK06-07



Big 12 pcs

	DK12-01
	DK12-02
	DK12-03
	DK12-04
	DK12-07





MO DE RN



The Modern series combines functionality with modern design.

Particularly, the units can be adjusted to various rooms and different expectations from older and younger users. Five cabinet sizes, optional doors and top sections, a large display area, space for trays selected individually for size and colour - all these features make this set very practical and easy to use. The modern colour scheme will create bright atmosphere in every room.

- 5 heights of standard cabinets:
57 cm, 76 cm, 95 cm, 114 cm, 134 cm;
- 5 heights of cabinets with top extensions:
131 cm, 150 cm, 169 cm, 188 cm, 208 cm;

Extras:

- plastic trays (deep, shallow and maxi);
- cardboard trays (deep and shallow);
- doors to cabinets and upper sections;
- locks for selected models

TECHNICAL SPECIFICATION:

BODY:

board: chipboard
thickness: 18 mm
colour: birch



base: board

ADD-ON:

board: chipboard
thickness: 18 mm
colour:



SHELVES:

board: chipboard
thickness: 18 mm
colour: birch



height
adjustment: yes

board: HDF
thickness: 3,2 mm
colour: white



height
adjustment: yes

DOORS:

type: opened
board: MDF
thickness: 12 mm
surface: smooth
colour:



type of handle:
cutout
lock: yes

TRAYS:

material: plastic
colour:



material:
cardboard
colour:



FURNITURE OF MODERN SERIES

CORNER

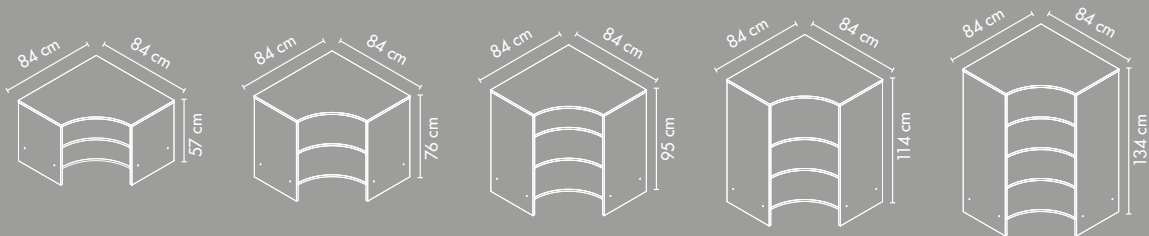

SHELF

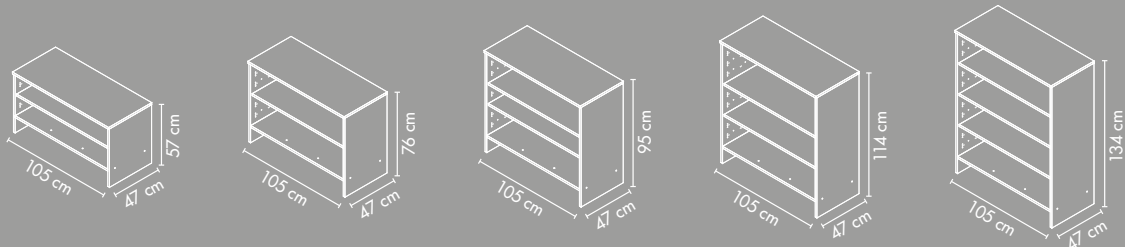

TRAYS

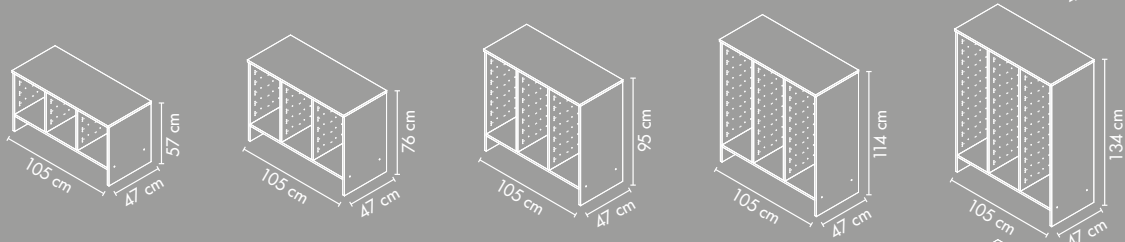

COMPARTMENTS

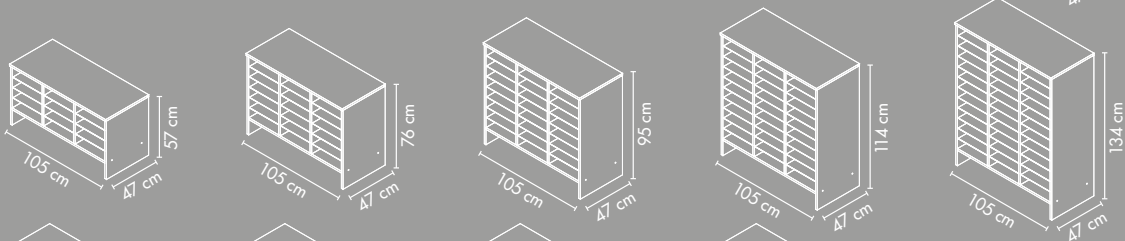

TALL CABINETS

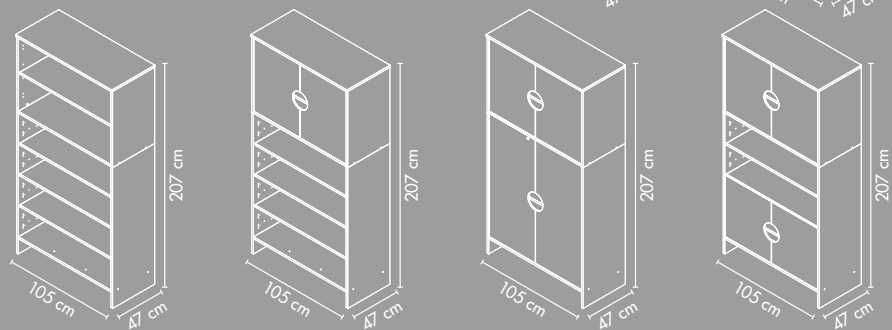

ADD-ON

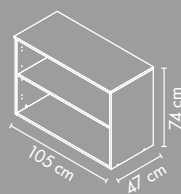

FEATURES

each type available in 5 heights



optional door in two colours, sold separately

The upper section is not a separate unit; the shelf is functional after the top section is assembled.

universal top unit to fit all units in the series irrespective of their sizes (except the corner units)

top unit in white, grey, orange or green only



Lock on door
ND2485, ND2475,
NS2455 i NS2465



colour:
birchwood



corner unit

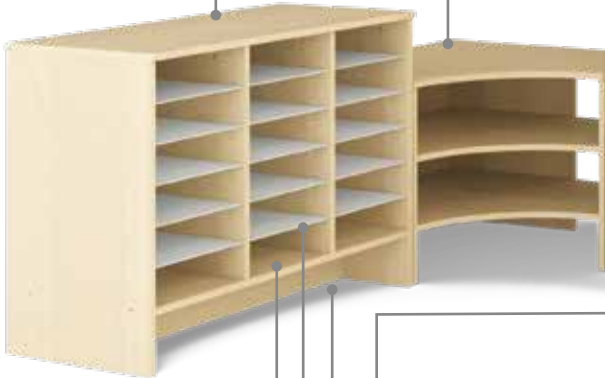

compartment size:
32 x 42 x 9 cm

doors sold separately

adjustable shelf height;
optional extra shelves NS2490

4 types of trays;
all sold separately

medium shelving unit

deep unit 47 cm



UNITS WITH SHELVES

doors sold separately



S
NS2401



M
NS2402



L
NS2403



X
NS2404



XL
NS2405



SHELF



Shelf
NS2490

• dim.: 100 x 42 cm



DOORS

The furniture series "Modern" combines functionality with the latest trends in interior design. It offers not only a wide range of cabinet heights to choose from but also the possibility of installing doors, add-ons and containers. These solutions allow you to

arrange the interior according to your needs. The use of classic white and grey colour favors cognitive activity and makes the space more peaceful. Light, natural colours are a safe choice for interior design in various styles. They work well with different materials and surfaces.



sold in pairs



Doors ND2485, ND2475,
NS2455 and NS2465
sold with a lock



S



M



L



X



XL

	white	ND2471	ND2472	ND2473	ND2474	ND2475
	grey	ND2481	ND2482	ND2483	ND2484	ND2485
	orange	NS2451	NS2452	NS2453	NS2454	NS2455
	green	NS2461	NS2462	NS2463	NS2464	NS2465

UNITS WITH COMPARTMENTS

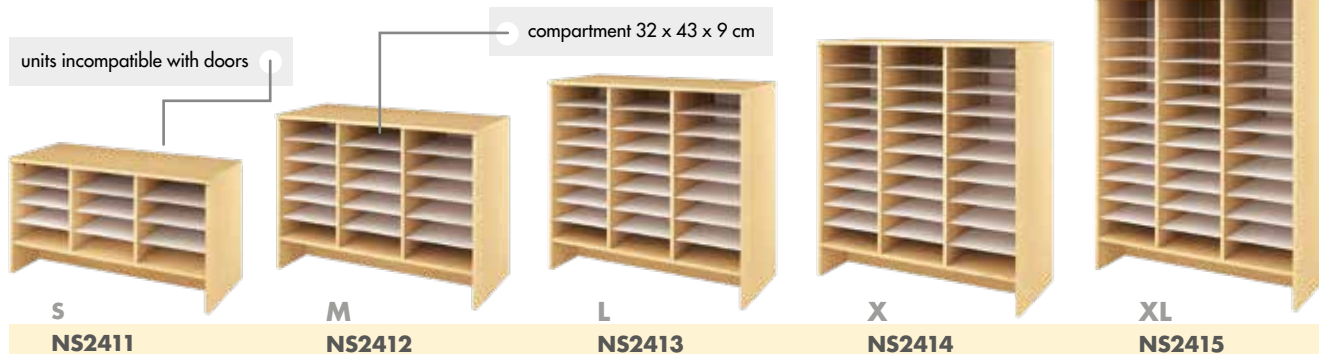

UNITS FOR TRAYS



ADD-ON

Fits all units in the series (except corner ones) to provide even more storage area

- not standalone; available in 4 colours;
- material: white laminated chipboard, 18 mm thick



	white	ND2443
	grey	ND2444
	orange	NS2441
	green	NS2442

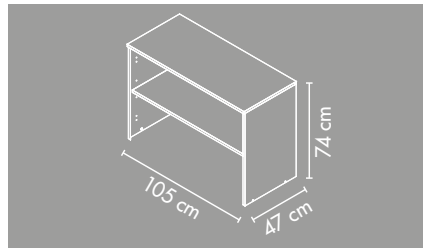

NOT A STANDALONE UNIT
functional only with a base
unit underneath



HOW DOES IT WORK?



DOORS



Doors for add-on

- dim.: 49,5 x 69 cm;
- sold in pairs

	white	ND2476
	grey	ND2486
	orange	NS2456
	green	NS2466



TRAYS

Plastic containers for Cubo, Fresh and Modern line furniture. They are perfect for implementing creative storage ideas. The wide selection of colours and sizes allows you to create unique arrangements which can be easily modified at any time. All containers are made of durable material.

- in the shape of a rectangle; material: plastic; intended use: storage



MAXI

• dim.: 31 x 42 x 30 cm



1 pc

	NS2348		NS2352
	NS2349		NS2353
	NS2350		NS2355
	NS2351		NS2354

DEEP

• dim.: 31 x 42 x 16 cm



2 pcs

	NS2317		NS2315
	NS2320		NS2316
	NS2318		NS2327
	NS2319		NS2326

PLASTIC

Plastic runners included in the set



3 pcs

	NS2356		NS2331
	NS2357		NS2330
	NS2358		NS2301
	NS2359		NS2300



4 pcs

	NS2360		NS2333
	NS2361		NS2332
	NS2362		NS2303
	NS2363		NS2302



6 pcs

	NS2364		NS2337
	NS2365		NS2336
	NS2366		NS2307
	NS2367		NS2306

SHALLOW

• dim.: 31 x 42 x 7 cm



4 pcs

	NS2383		NS2381
	NS2386		NS2382
	NS2384		NS2397
	NS2385		NS2396



6 pcs

	NS2368		NS2335
	NS2369		NS2334
	NS2370		NS2305
	NS2371		NS2304



8 pcs



	NS2372		NS2339
	NS2373		NS2338
	NS2374		NS2309
	NS2375		NS2308

CARDBOARD



deep 4 pcs



- dim.: 42 x 31 x 15 cm;
- the set comes with runners

	NS2478	orange
	NS2479	green



shallow 8 pcs





- dim.: 42 x 31 x 7 cm;
- the set comes with runners

	NS2476	orange
	NS2477	green



deep 6 pcs





- dim.: 42 x 31 x 15 cm;
- the set comes with runners

	ML2474	marine
	ML2473	grey
	NS2473	orange
	NS2474	green



shallow 12 pcs

- dim.: 42 x 31 x 7 cm;
- the set comes with runners

	ML2472	marine
	ML2471	grey
	NS2471	orange
	NS2472	green

INSERTS

Inserts for plastic trays

- recommended for shallow trays;
- polystyrene;
- dim.: 40 x 275 x 388 mm;
- thickness: 1,5 mm



- 4 compartments
NS1377



- 6 compartments
NS1376







- 8 compartments
NS1375



TALL CABINETS







Shelving unit

	NS2431	orange
	NS2432	green
	ND0070	white
	ND0080	grey







Shelving unit with 2 doors

	NS2435	orange
	NS2436	green
	ND0072	white
	ND0082	grey







Shelving unit with door

	NS2433	orange
	NS2434	green
	ND0071	white
	ND0081	grey



Shelving unit with 2 door

	NS2437	orange
	NS2438	green
	ND0073	white
	ND0083	grey



MOBILE CABINET



top for chemical and biological accessories



4 castors with brakes included

trays sold separately

Science Cart NM4033

Experiments require accessories. This unit will hold them all in trays. Transportation is easy - just grab the handles and move the cart to its destination.

- dim.: 68,5 x 45 x 88 cm;
- will hold 6 large or 12 small trays (sold separately);
- castors with brakes

TREASURE ISLAND

The basic module can be equipped with accessories (sold separately). The bays can hold shelves or trays. Optional doors (in 4 colours) can be mounted on wide-angle hinges. Another useful accessory is a city road play mat (on which to construct houses and drive toy cars)

- small island dim: 83 x 83 x 53 cm (with castors); top 76 x 76 cm, 4 castors with brakes;
- maxi island dim.: 124 x 83 x 53 cm (with castors); top 76 x 117 cm, 5 castors with brakes

4 types of trays; alternatively shelves

basic module always in birch

All elements sold separately



rounded corners

4 castors with brake

doors in 4 colours; wide angle hinges (270°)

large play area top 76 x 76 cm (optional mat HK0007)

Treasure Island NS2409

- basic module for configurations;
- birch finish;
- 4 castors with brakes





**City road rollover
HK0007**

- dim.: 75 x 75 cm;
- antislip bottom

**Maxi treasure island
NS2410**

- basis for configurations;
- dim.: 124 x 83 x 53 cm (with castors);
- top: 76 x 117 cm;
- 5 lockable castors



DOORS AND SHELVES FOR TREASURE ISLAND



	NS2487	orange
	NS2488	green



	NS2467	white
	NS2468	grey

**Maxi city road rollover
HK0014**

fits Maxi Treasure Island (NS2410)

- dim.: 75 x 115 cm;
- antislip bottom

MOBILE CHEST

A practical box with a lid and on castors for easy storage of sports equipment indoors. Padlockable.

- dim.: 138 x 63 x 70 cm



**Chest for sports equipment
NS2906**

- MDF chipboard in grey and orange



**Chest for sports accessories
ML2906**

- MDF chipboard in marmara blue and and grey





EXCLUSIVE

Modern furniture collection ideal for creating any workspace in educational institutions. The furniture's system helps to arrange headmaster's office and secretariats functionally and aesthetically. This collection is also well suited for arranging open or regular office spaces and conference rooms. Practical desks with storage space for documents and other accessories ensure optimal working conditions. They are equipped with several innovative solutions which allow users to adjust them to individual preferences and the nature of work. Reception desks characterised by simple construction and sweeping forms endow elegant and welcoming interiors. A perfect addition to every office is a round coffee table which is also available in our offer. For storing, we recommend spacious chests of drawers, cabinets and two-door wardrobes. This solid furniture line was made of durable chipboard, 18 and 25 mm thick. Simple shapes and versatile colours inspired by natural birch wood combined with subtle white fronts bring harmony into the interior, stimulate creativity and favour decision-making.

FRAME

chipboard
thick 25 mm
base: chipboard
colour birch



DOOR

chipboard
thick 18 mm
smooth surface
no lock
colour:



birch



white

SHELVES

chipboard
thick 25 mm
colour birch



HANDLES

aluminium handles



board MDF
thick 6 i 12 mm
colour white



EXCLUSIVE LINE

CABINETS

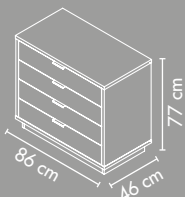
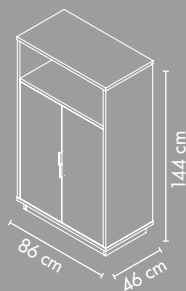
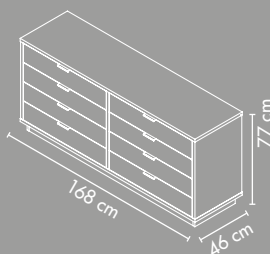
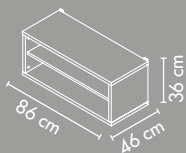
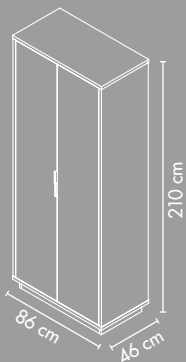

CHEST OF DRAWERS

HEADMASTER'S DESK

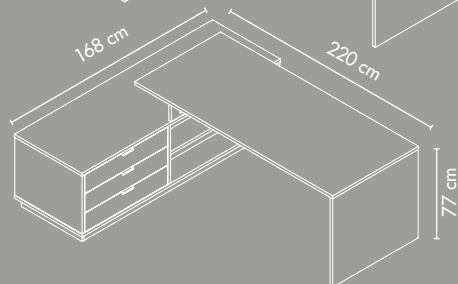
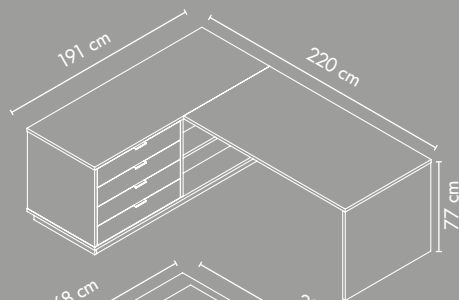

RECEPTION DESK

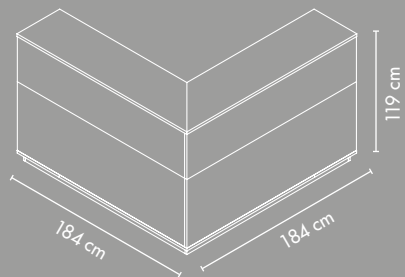

TABLE

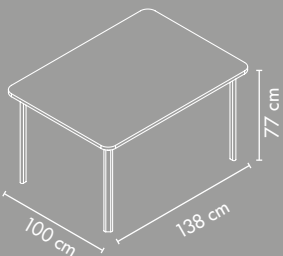
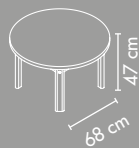

EXCLUSIVE

CHEST OF DRAWERS

- material: frame made of chipboard, 25 mm thick;
- drawer fronts made of chipboard, 18 mm thick



Chest of drawers

- dim.: 85,5 x 45,5 x 77 cm;
- 4 shelves

	birch	EXC1291
	birch and white	EXC1293



Maxi ches of drawers

- dim.: 168 x 45,5 x 77 cm;
- 8 shelves

	birch	EXC2291
	birch and white	EXC2293

SHELVES



Hanging shelf

- dim.: 85,5 x 35,5 x 36 cm;
- material: chipboard, 25 mm thick

	birch	EXC3101
--	--------------	----------------

CABINETS

- material: frame made of chipboard, 25 mm thick;
- doors made of chipboard, 18 mm thick



Wardrobe

- dim.: 85,5 x 45,5 x 210 cm;
- two-door wardrobe equipped with a rod and a shelf

	birch	EXC1661
	birch and white	EXC1663



Medium cabinet with a pair of doors

- dim.: 85,5 x 45,5 x 143,5 cm;
- an open shelf, 3 shelves with a pair of doors

	birch	EXC1431
	birch and white	EXC1433



Tall cabinet

- dim.: 85,5 x 45,5 x 210 cm;
- 6 open shelves; material: chipboard, 25 mm thick

	birch	EXC1601
--	--------------	----------------



RECEPTION DESKS



Reception desk

- dim.: 183,5 x 183,5 x 119 cm;
- 2 containers with 3 drawers, 4 dividers;
- material: frame made of chipboard, 25 mm thick;
- table top made of chipboard, 25 mm thick;
- dividers, drawer fronts and soles are made of chipboard, 18 mm thick



	birch	EXC9001
	birch and white	EXC9003



DESKS

- material: frame made of chipboard, 25 mm thick;
- drawer fronts made of chipboard, 18 mm thick;
- tabletop made of chipboard, 25 mm thick



Headmaster's desk with raised table top and drawers

- dim.: 220 x 190,5 x 77 cm;
- 6 drawers, 4 open shelves

	birch	EXC5281
	birch and white	EXC5283



Headmaster's desk with drawers

- dim.: 220 x 168 x 77 cm;
- 8 drawers, 4 open shelves;

	birch	EXC5291
	birch and white	EXC5293

CONFERENCE AND COFFEE TABLES

- material: tabletop made of chipboard, 25 mm thick;
- socles made of chipboard, 18 mm thick



Table top for the conference table

- dim.: 138 x 100 x 77 cm



	birch	EXC8261
	birch and white	EXC8263



Table top for the conference table

- dim.: 68 x 68 x 46,5 cm

	birch	EXC8111
	birch and white	EXC8113

WOODEN ERGO LEGS

SETS

- legs with a trapezoidal cross-section with rounded edges;
- material: solid beech wood



4 pcs

NS0053 height 2 (51 cm)

NS0076 height 6 (76 cm)







TRAIN



Train. A chain of storage units imitating a train (engine + carriages). Its length is limited only by the size of the room. The fancy shapes and multicoloured finish turn the room into a fantasy world. A very functional set which provides a lot of space for display and storage. The cupboards are made of white laminate. The doors, drawers applications in delicate pastel colours add liveliness to the whole interior.

BODY:

board: chipboard
colour: white



thickness: 18 mm
base: board

DOORS:

type: opened
board: chipboard
surface: smooth
colours:



thickness: 12 mm
type of handle: wooden

ADD-ONS:

board: MDF
surface: smooth
thickness: 12 mm
colours:

**DRAWERS:**

board: chipboard / MDF
front colours:

SHELVES:

board: chipboard
thickness: 18 mm
colour: white



TRAIN FURNITURE

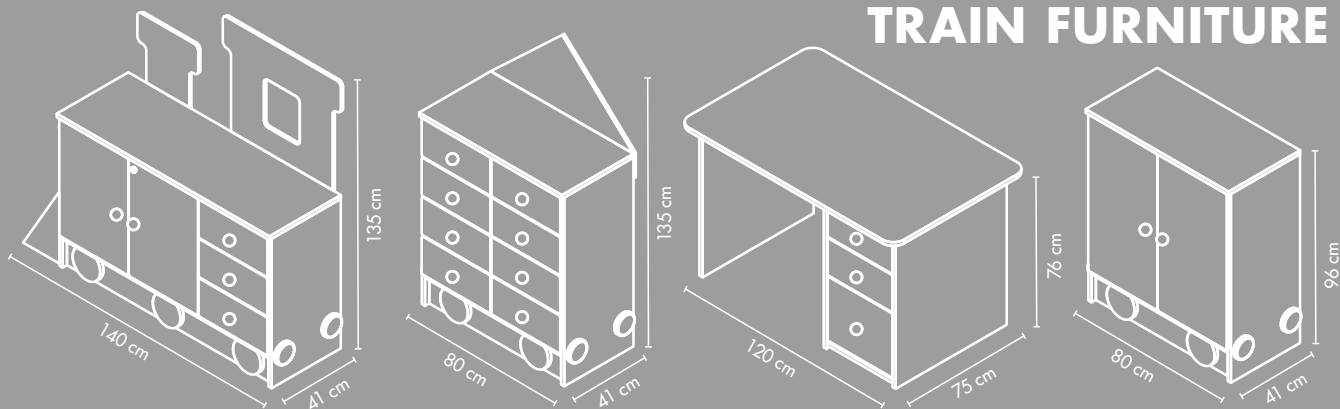

FEATURES



colourful decorative back panels



wheel imitations with all modules in the series

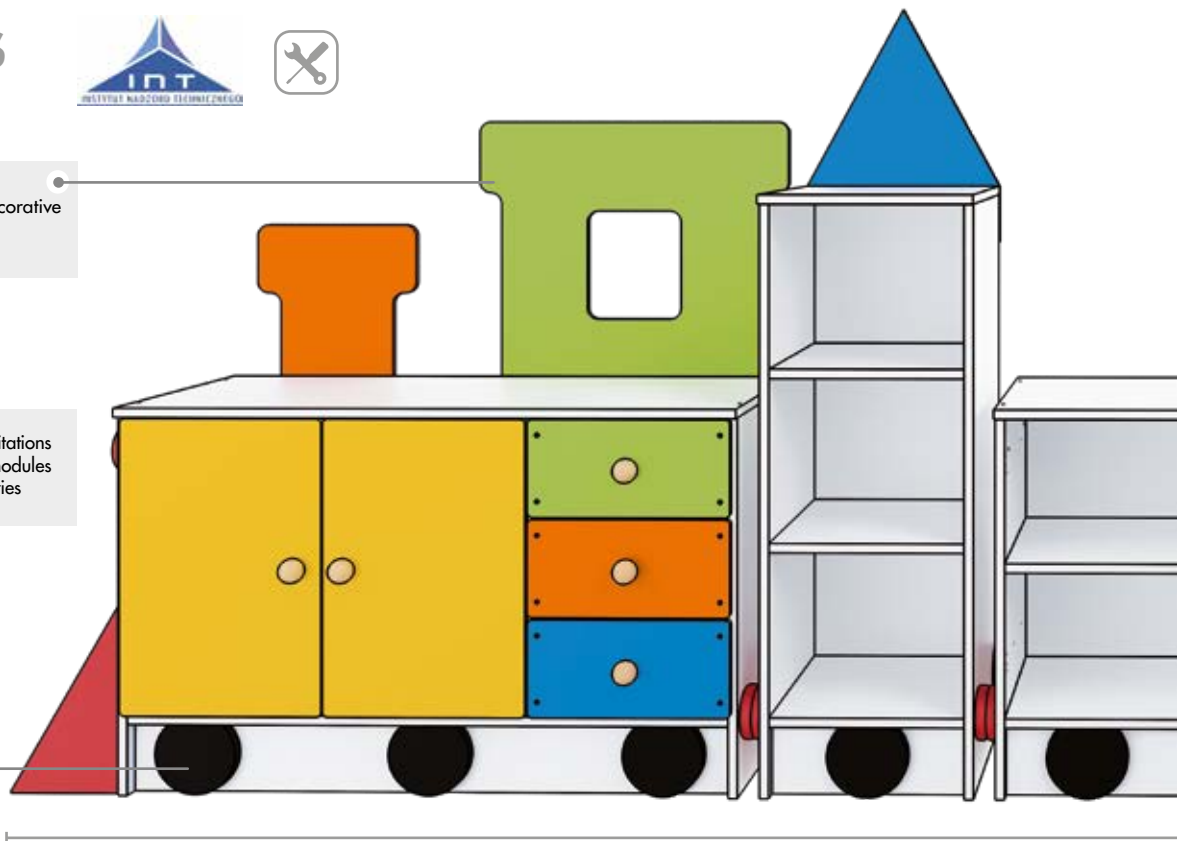

4,4 m

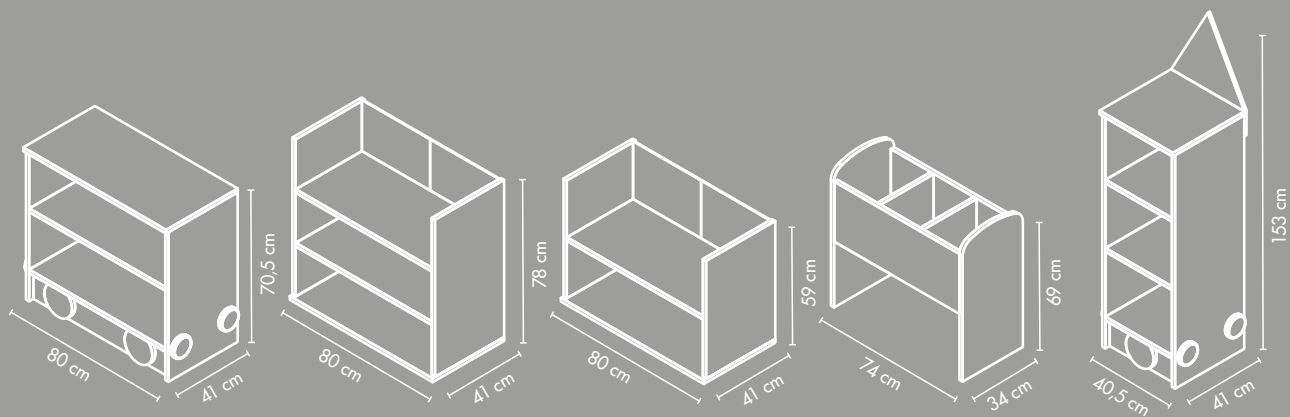

buffer imitations
sold separately



spacious drawers
with a safety stop



CABINETS

foam bumper and front light imitations come with the engine

furniture heights measured with the back panel

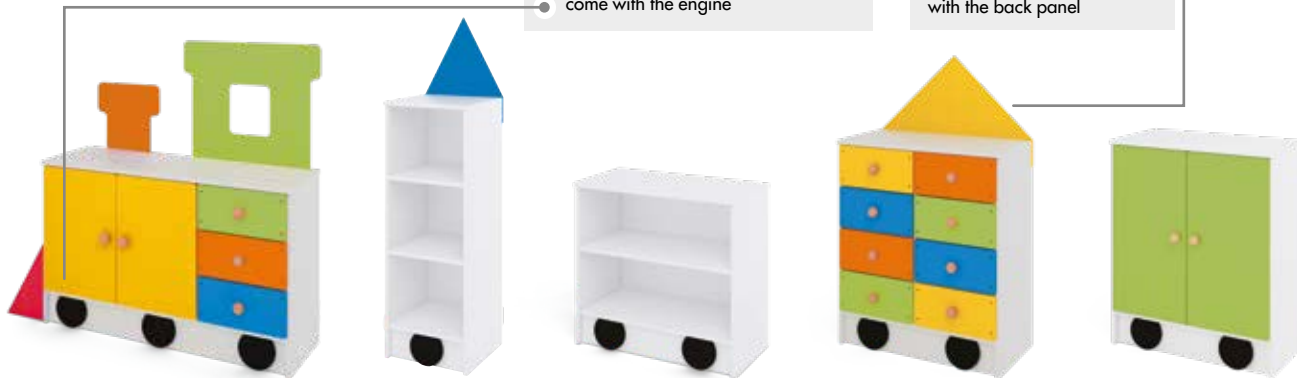

**Engine
NS0239**

- dim.: 111 x 41 x 135 cm

**Carriage 3
NS0242**

- dim.: 40,5 x 41 x 153 cm

**Carriage 4
NS0243**

- dim.: 80 x 41 x 70,5 cm

**Carriage 1
NS0240**

- dim.: 80 x 41 x 135 cm

**Carriage 2
NS0241**

- dim.: 80 x 41 x 96 cm;
- 2 shelves inside

SETS

**Train Set
NS0256**

- engine + 4 carriages;
- total length: 4,4 m with buffers

TRAIN SET

total length: 440 cm with buffers

The set consists of:

- Engine, Carriage 1, Carriage 2, Carriage 3, Carriage 4



4,4 m

DESK

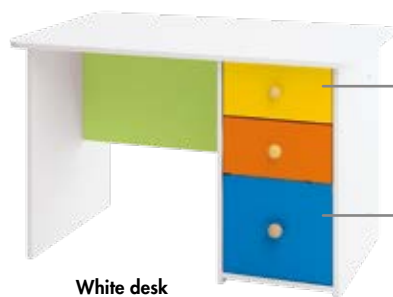

• small drawer
dim.: 32 x 42 x 16 cm

• large drawer
dim.: 32 x 42 x 29 cm

White desk
NS0257

- dim.: 120 x 75 x 76 cm

ACCESORIES



Buffers
LO0049

- 2 pcs



SHELVES



Dark blue
NS1773

- dim.: 90 x 22 x 43 cm



Mint
NS1772

- dim.: 90 x 22 x 43 cm



Shelf sun
NS8110

- dim.: 70 x 16 x 57 cm



Shelf grass
NS8111

- dim.: 82 x 16 x 36 cm

TRAIN ADD-ON



Low add-on
NS1243

A low add-on module with a pair of doors and handles.

- dim.: 80 x 40 x 59,2 cm; 2 white shelves;
- body: laminated chipboard 18 mm (white);
- fronts: MDF board 12 mm (yellow)



Low add-on module
NS1244

A low add-on module.

- dim.: 80 x 40 x 59,2 cm;
- 2 white shelves;
- body: laminated chipboard 18 mm (white)



Tall add-on
NS1241

A tall add-on module with a pair of doors and handles.

- dim.: 80 x 40 x 78,2 cm; 2 white shelves;
- body: laminated chipboard 18 mm (white);
- fronts: MDF board 12 mm (green)



Tall add-on module
NS1242

A tall add-on module.

- dim.: 80 x 40 x 78,2 cm; 2 white shelves;
- body: laminated chipboard 18 mm (white);
- fronts: MDF board 12 mm (green)



12 NEW FURNITURE





SCREENS

Colourful, aesthetic room screens. Their sizes and designs will make any space look more accessible, friendly, and interesting. To divide a bigger room, for example to create thematic corners, teacher may want to choose short room

screens which will allow them to keep an eye on children while they play. Additionally, the screens can be used as playpens.

- fabric – cotton, plywood frames and MDF legs



SHORT



blue
NS0092

- dim.: 83 x 68,5 cm



green
NS0093

- dim.: 83 x 68,5 cm



orange
NS0091

- dim.: 83 x 68,5 cm



yellow
NS0094

- dim.: 83 x 68,5 cm



**Set of short screens
NS9500**

- low partitions 91 x 37 x 75,5 cm (different colours) – 7 pcs;
- connectors 60°, 2 sets;
- straight connectors, 2 sets

colours in the set



**Screen tulip
NS0905**

- dim.: 90 x 77 cm



**Screen sunflowers
NS0903**

- dim.: 90 x 77 cm



TALL

• dim.: 90 x 167 cm



5 different size pockets

5 balloons with holes



Screen Caterpillar
NS1951

Two types of fastenings and a zipper. Pockets of various sizes for storage.

Screen Balloons
NS1952

A screen with 5 balloon pictures. Each has a hole through which to throw small balls or bean bags.



3 pockets

5 boat shaped pockets



Screen Clouds
NS1953

A screen with 3 bag-like pockets

Screen Sailing boats
NS1954

A screen with 5 sailing boat-shaped pockets varying in size, colour and the number of buttons.





Colourful theatre
NS1955

It features drawable curtains and large pockets for storing puppets or smaller props. A long pocket for displaying the title of the play and the actors' names.



ACCESSORIES

SCREEN CONNECTORS



Straight
NS0956

- 2 pcs;
- join screens at one line



60°
NS0957

- 2 pcs;
- join screens at angle 120°



90°
NS0958

- 2 pcs;
- join screens at angle 90°

LIBRARY









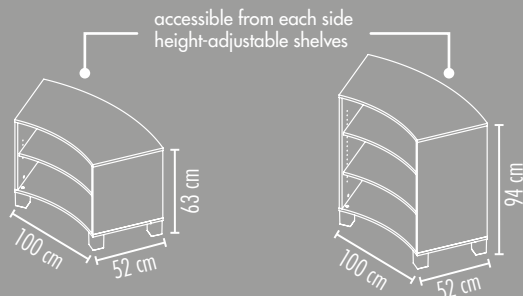

FRESH

CORNER UNITS





With these open-frame bookcases accessible from each side you will maximize the available floor space. Units can be combined into gently curved forms, thus adding a modern and creative flavour to the room. Available in two sizes and three colour versions of shelves.



Small

	NM7071	orange
	NM7072	green
	NM7073	birch
	NM7074	white
	NM7075	grey

Big

	NM7001	orange
	NM7002	green
	NM7003	birch
	NM7004	white
	NM7005	grey

FRESH FOAM

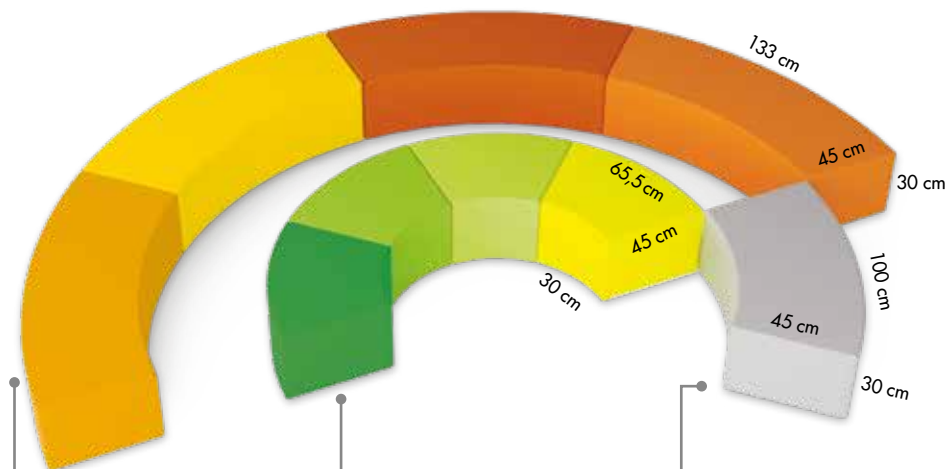

**Foam 1 Sunny
NS2180**

- 4 pcs, 133 x 30 x 45 cm;
- total length: 528 cm

**Foam 2 Green
NS2179**

- 4 pcs, 65,5 x 30 x 45 cm;
- total length: 300 cm

**Foam 3 Grey
NS2181**

- 1 pc: 100 x 30 x 45 cm

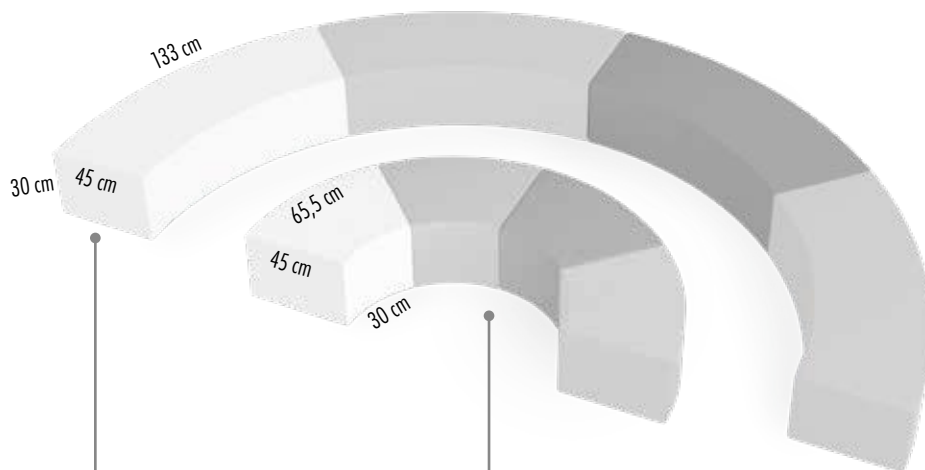

**Foam 1 Black and White
NS2259**

- 4 pcs, 133 x 30 x 45 cm;
- total length: 528 cm

**Foam 2 Black and White
NS2260**

- 4 pcs, 65,5 x 30 x 45 cm;
- total length: 300 cm







Wall book display

• dim.: 92 x 17 x 105 cm

	NM9311	orange
	NM9312	green
	NM9314	white
	NM9315	grey



Bookcase

• dim.: 92 x 45 x 94 cm

	NM9201	orange
	NM9202	green
	NM9204	white
	NM9205	grey

foam mat



Bookcase

• dim.: 92 x 45 x 38 cm

	NM9401	orange
	NM9402	green
	NM9404	white
	NM9405	grey



Book Display

• dim.: 92 x 45 x 116 cm

	NM9331	orange
	NM9332	green
	NM9334	white
	NM9335	grey



Double sided book display

• dim.: 92 x 45 x 116 cm

	NM9321	orange
	NM9322	green
	NM9324	white
	NM9325	grey



**Book Display
NM9110**

• dim.: 92 x 45 x 116 cm



**Container
NM9120**

• dim.: 86 x 45 x 33 cm



**Bookcase
NM9500**

• dim.: 45 x 45 x 49 cm

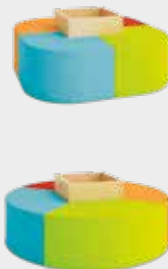

Legs

• 4 pcs; 7 x 7 x 10 cm

	NJ0901	orange
	NJ0902	green
	NJ0903	beige



**Castors
NJ0904**

• 4 pcs; 2 with brakes;
• H 10 cm



FRESH SNAKE

An element intended to enrich the bookcase series Fresh. The coloured poufs will make great seats for children to relax while listening to a story or reading a favourite book. The set of nine soft poufs can be used as a decoration in each room. The elements can also be joined together as puzzle pieces and so inspire children to play creatively in a playgroup or at school. All the elements are ergonomic and easy for children to carry around and arrange as they please, and they are safe thanks to no sharp edging. The cover is nice to the touch and easy to clean.

- particular elements can form a pouf around a box to match the bookcase Fresh (NM9500);
- it is possible to buy only four elements with which to form a cube (NM0010), a circle (NM0020) or an oval (NM0015)

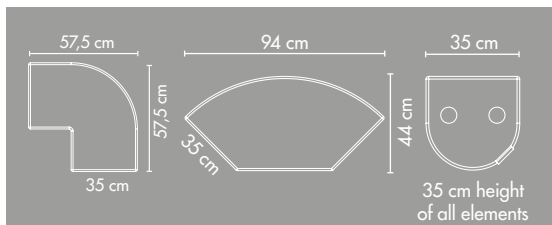

**Pouf – Oval
NM0015**

- 2 pieces dim.: 58 x 58 x 35 cm in blue and green,
- 2 pieces dim.: 67 x 67 x 35 cm in orange and green



**Pouf - Cube
NM0010**

- 4 pcs dim.: 58 x 58 x 35 cm in orange, blue, green and red



**Pouf – Circle
NM0020**

- 4 pcs dim.: 67 x 67 x 35 cm in orange, blue, green and red

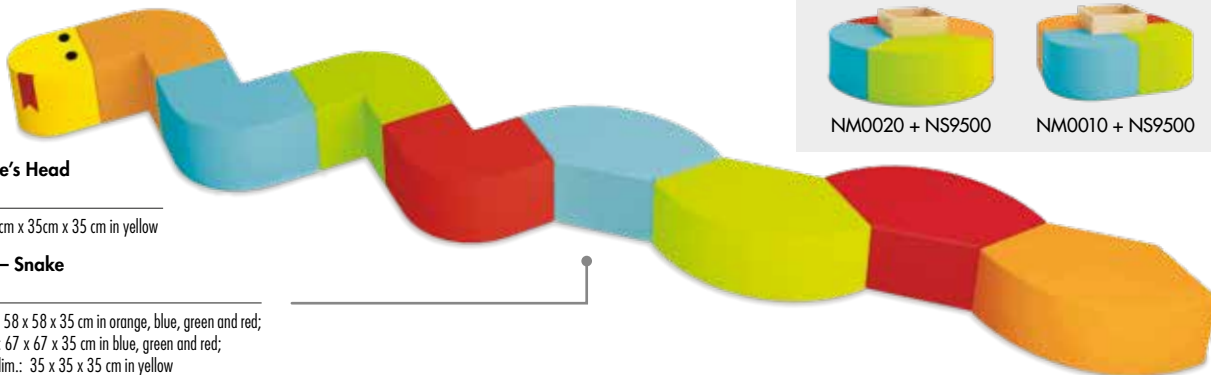

**Pouf – Snake's Head
NM0001**

- 1 pc; dim.: 35cm x 35cm x 35 cm in yellow

**Foam seats – Snake
NM0100**

- 4 shapes dim.: 58 x 58 x 35 cm in orange, blue, green and red;
- 4 shapes dim.: 67 x 67 x 35 cm in blue, green and red;
- snake's head dim.: 35 x 35 x 35 cm in yellow

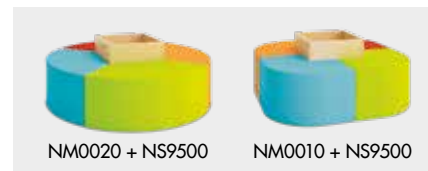

WITH POUFS

Book storage unit with poufs

Double-sided unit with compartments for books, two poufs and two containers on casters. Laminated chipboard. Colour: birchwood. Safe rounded edges.

- book container, 2 containers on wheels, 2 poufs

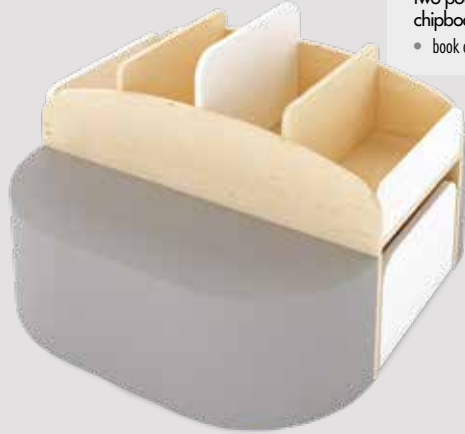

with grey poufs and birch & white boxes
NS9741

with orange poufs and birch & green boxes
NS1741

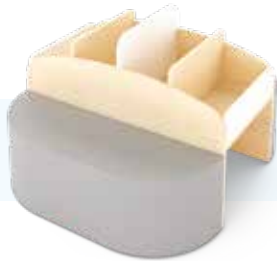

Book container with poufs

- container: dim.: 50 x 92 x 64 cm;
- poufs: dim.: 44 x 45 x 28 cm

NS9742

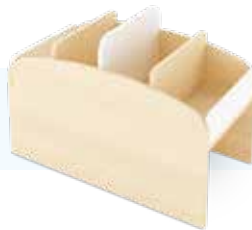

Book container

A bookcase unit with 4 compartments and space for two boxes underneath

- dim.: 50 x 92 x 64 cm

NS9743



Containers on wheels

- 2 pcs;
- dim.: 44 x 45 x 28 cm

NS9744



Rounded poufs

- 2 pcs;
- dim.: 30 x 92 x 30 cm

NS9745



NS1742

NS1743

NS1744

NS1745

BOOK CONTAINER

This child-friendly furniture will be an ideal central point of the reading corner but it can easily make a handy storage space for games, building blocks and other toys. It is easily accessible from each side and the comfortable pouffes add to its functionality. It will be useful both in nurseries and daycares.

- 3 colours; dim.: 74 x 34 x 69 cm



Beech
NS1706

- dim.: 74 x 34 x 69 cm



Birch
NS1707

- dim.: 74 x 34 x 69 cm



White
NS1708

- dim.: 74 x 34 x 69 cm



Poufs for container
NS1709

- 2 pcs, dim.: 35 x 35 x 30 cm



BEECH BOOK DISPLAYS



doublesided:
3 display tiers on one side
3 shelves on the other



**Small double-sided
NS0877**

• dim.: 90 x 40 x 102 cm

doublesided:
4 display tiers on one side
4 shelves on the other



**Tall double-sided
NS0878**

• dim.: 90 x 40 x 115 cm

wall-mounted



**Wall mounted
NS1721**

• dim.: 94 x 20 x 130 cm

BIRCH BOOK DISPLAYS



Double sided & mobile container set NS1484

- dim.: 95 x 42 x 30 cm;
- NS1481 – 102 x 45 x 125 cm



wall-mounted or free-standing
4 tiers of shelves



Wall mounted NS1483

- dim.: 92 x 16 x 124 cm

Book & Mobile containers set NS1485

- dim.: 95 x 42 x 30 cm;
- NS0279 – 102 x 42 x 70 cm



compartments with movable dividers



Book container NS0279

- dim.: 102 x 42 x 70 cm

Double sided NS1481

- dim.: 102 x 45 x 125 cm



double-sided



storage cart with compartments;
supplement for NS1481 or NS0279



Mobile container NS1482

- dim.: 95 x 42 x 30 cm

BOOKCASE LETTER

for storing books, games, toys; ideal for theme corners. Sides made of laminate; 5 deep pockets

- dim.: 72 x 34 x 92 cm



5 deep pockets
heavy-duty polyester fabric

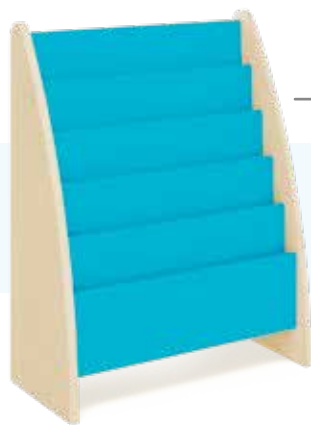

Turquoise
NS2719



Grey
NS1719



Green
NS1705



SCHOOL BOOK STORAGE

FREESTANDING UNITS

The units have a sturdy metal frame. The shelves are made of laminated chipboard and have stops to protect books from sliding down. Versions available: single-module double-sided (NLO491), triple-module double-sided (NLO493), double-sided extensions (NLO492). Intended for schools and other educational institutions.

- dim.: 254 x 49 x 189 cm;
- 36 shelves



Single module; double-sided
NLO491

- dim.: 87 x 49 x 189 cm;
- 12 shelves H 31 cm

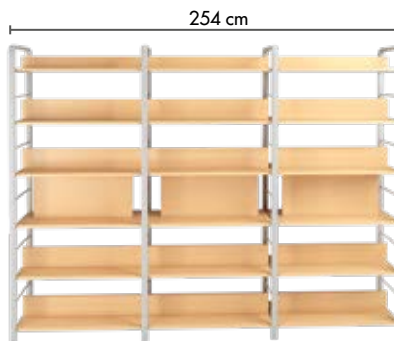

3 modules; double-sided
NLO493

- dim.: 254 x 49 x 189 cm;
- 36 shelves H 31 cm



Double-sided add-on
NLO492

- dim.: 85 x 49 x 189 cm;
- 12 shelves H 31 cm

WALL UNITS

The units have a sturdy metal frame. The shelves are made of laminated chipboard and have stops to protect books from sliding down. Versions available: single-module double-sided (NLO341), triple-module double-sided (NLO343), double-sided extensions (NLO342). Intended for schools and other educational institutions.

- dim.: 85 x 34 x 189 cm;
- 36 shelves



Single module
NLO341

- dim.: 87 x 34 x 189 cm;
- 6 shelves H 31 cm

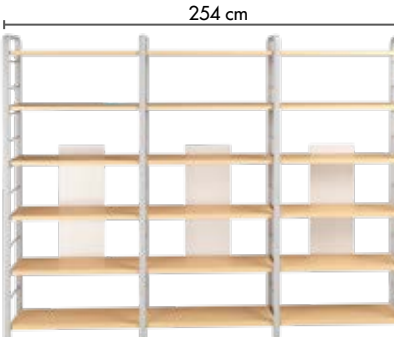

3 modules
NLO343

- dim.: 254 x 34 x 189 cm;
- 18 shelves H 31 cm



Add-on
NLO342

- dim.: 85 x 34 x 189 cm;
- 6 shelves H 31 cm

TALL BOOK CABINETS

TALL FRESH CABINET

- dim.: 92 x 45 x 176 cm (with legs);
- body colour: birch;
- 5 adjustable shelves;
- 4 legs (beige);
- laminated particleboard 18 mm, plastic

height-adjustable shelves



- with birch shelves
NM3003



- with white shelves
NM3004



- with grey shelves
NM3005

TALL PRIMA CABINET

- dim.: 90 x 40 x 190 cm



- with birch shelves
NB2001



- with beech shelves
NB2002







DISPLAY UNITS



Apple
NS0433

• dim.: 116 x 55 x 118 cm

W 116 cm
D 55 cm
H 118 cm



Frog
NS0906

• dim.: 108 x 47 x 120 cm

W 108 cm
D 47 cm
H 120 cm





Sun
NS0473

- dim.: 180 x 61 x 140 cm

W 180 cm
D 61 cm
H 140 cm



Owl
NS0907

- dim.: 116 x 40 x 120 cm

W 116 cm
D 40 cm
H 120 cm



Pear
NS0432

- dim.: 105 x 54 x 160 cm;
- with leaf

W 105 cm
D 54 cm
H 160 cm



Junior Pear
NS1826

- dim.: 90 x 45 x 140 cm;
- with leaf

S 90 cm
D 45 cm
H 140 cm



Apple Tree
SK0003

- dim.: 132 x 65 x 150 cm

W 132 cm
D 65 cm
H 150 cm



Corner Apple Tree
SK0004

- dim.: 65 x 65 x 150 cm

W 65 cm
D 65 cm
H 150 cm



MULTIFUNCTION CABINETS

FOR MUSICAL INSTRUMENT

MOBILE CABINET WITH MUSICAL INSTRUMENTS

Cubo. Mobile cabinet with musical instruments NC4200

Mobile cabinet providing functional storage space for sport accessories, musical instruments, art&craft materials. It can also be used as a container for a two-station desk. Equipped with an open shelf and white, grey and lime coloured drawers with access on both sides (drawers sold separately). Wheels make moving the cabinet with its contents easier.

- dim.: 76,6 x 72,2 x 86,7 cm (without wheels);
- material: birch-coloured chipboard
- 4 plastic wheels;
- 4 drawers (lemon grass and grey);
- 20 kinds of musical instruments



MOBILE CABINET FOR DRAWERS



equipped with an open shelf and drawers with access on both sides



fits narrow deep or shallow CUBO drawers

Cubo. Mobile cabinet for drawers NC4100



















Mobile cabinet providing functional storage space for sport accessories, musical instruments, art&craft materials. It can also be used as a container for a

two-station desk. Equipped with an open shelf and drawers with access on both sides. Wheels make moving the cabinet with its contents easier.

- dim.: 76,6 x 72,6 x 86,7 cm (without wheels)





 Claves (4 pcs)	 Xylophone (2 pcs)	 Wooden handle with 5 bells (2 pcs)	 Triangle (3 pcs)
 Guiro (1 pc)	 Bell with a handle (8 pcs)	 Drum 25 cm (1 pc)	 Wooden colorful maracas (2 pcs)
 Tone block (1 pc)	 Handle with cymbals (1 pcs)	 Bells for wrist crankle (2 pcs)	 Acoustic box (2 pcs)
 Wooden maracas (2 pcs)	 Waist bang (1 pc)	 Tambourine with membrane 21 cm (1 pc)	 Wooden maracas eggs (2 pcs)
 Shaker with grater (1 pc)	 Wooden castanets (2 pcs)	 Cymbals (2 pcs)	 Tambourine 21 cm (1 pc)
 Castanets with handle (1 pc)	42 INSTRUMENT IN SET (21 TYPES OF INSTRUMENTS)		



**Music trolley
PG9015**

Intended for children's instruments.

- dim.: 90 x 55 x 40 cm; only furniture

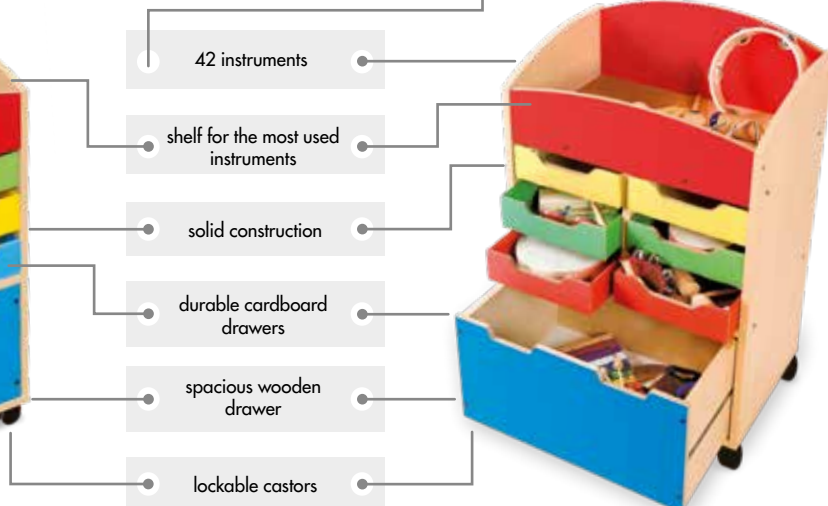

**Music trolley with instruments
PG9016**

Intended for children's instruments.

- dim.: 90 x 55 x 40 cm

FOR ART & CRAFT ACCESSORIES



large open shelves for storing



convenient accesson both sides cabinets



fits narrow deep or shallow CUBO drawers



Drawers sold separately and available on page 78



wheels make it easy to move



Cubo. Art Cabinet Turtle NC4001

Double-sided cabinet for art supplies. Equipped with open shelves for storing A3 and A4 brystols. Containers on the sides provide space for painting materials, paints and crayons. Spacious shelves enables safe

storage of items and articles that should not be easily accessible or require special storage. Wheels make it easy to move the cabinet to another place.

- dim.: 59 x 77 x 58 cm;
- material: birch-coloured chipboard;
- drawers sold separately

EXAMPLE ARRANGEMENT



NC4001

+



NC0013

+



NC0027

=



front



back



two-sided

space for large bottles of paint and glue



5 mobility castors, including 2 with a lock facility

Art. Cabinets Cubo NC4000

A double-sided mobile cabinet from the Cubo series for art materials. The cabinet has 3 tiers and 4 types of shelves:

- a large open shelf dim.: 77 x 38 x 10 cm;
- a small open shelf dim.: 36 x 38 x 10 cm;
- 9 shelves with colour dividers, dim.: 36 x 17 x 36 cm;
- 2 cabinet shelves dim.: 36 x 35 x 36 cm;
- whole unit dim.: 114 x 39 x 87 cm;
- framework: laminated particle board in birch colour;
- dividers: laminated particle board in turquoise, key lime or grey colour;
- 5 castors (including 2 with a lock facility);
- sold without art & craft materials



rounded corners

shelves for papers and art works

large drawer



Shelving unit Rainbow NS0464

A practical cabinet for sorting and storing art materials and accessories - on open shelves or in closed compartments or drawers. The whole consists of:

- an open top shelf dim.: 98 x 33 x 20 cm;
- a medium shelf dim.: 60 x 33 x 15 cm;
- 2 small shelves dim.: 29 x 33 x 30 cm;
- a compartment with a door dim.: 30 x 33 x 30 cm;
- a drawer dim.: 58 x 33 x 30 cm;
- the unit is made of laminated 18 mm chipboard in birch effect;
- the coloured elements are made of MDF and compartments of HDF;
- total dim.: 98 x 33 x 102 cm

Colourful and functional cupboards are a convenient way of organizing and storing all kinds of art materials. The variety of drawers, containers and cabinets guarantees efficient use of space. Besides, they are easy to use and they help reduce the load in schoolchildren's backpacks. Storage units on castors help move and organize classroom tools and materials according to current needs.



**Mobile activity table
NS0594**

- dim.: 62,5 x 42 x 67 cm;
- sold without accessories



**Art cabinet on wheels
NS0781**

- dim.: 80 x 75 x 40 cm;
- sold without accessories

UNIVERSAL

A mobile cabinet for storing and keeping in order various art materials on shelves or in all-purpose trays. Storage space for large-size cardboard.

- a small open shelf;
- a large open shelf;
- 2 large cabinet shelves;
- 4 plastic trays (1 deep, 3 shallow);
- 2 long bins for paint bottles;
- dim.: of the cabinet without bins : 98 x 45 x 76 cm;
- dim.: of the cabinet with bins : 98 x 58 x 76 cm

Materials:

- framework: laminated particle board in birch colour;
- fronts: MDF board in green colour; milled;
- 4 castors (including 2 with a lock facility)



long bins for paint bottles

large open shelf

4 castors, including 2 with a lock facility

4 plastic trays:
1 deep and
3 shallow

**- without accessories
NS0782**



**- with accessories
NS0783**

Contains:

- white drawing paper 250 pcs;
- white technical drawing paper A3 100 pcs;
- colour paper mix 25 pcs;
- craft tissue paper 30 pcs;
- class pack long crayons 300 pcs;

- tempera 1l 6 pcs;
- sponge brushes 4 pcs;
- brushes standard mix 24 pcs;
- plasticine classpack 180 sticks;
- vinilic glue 1l 1 pc;
- chenille stems 100 pcs

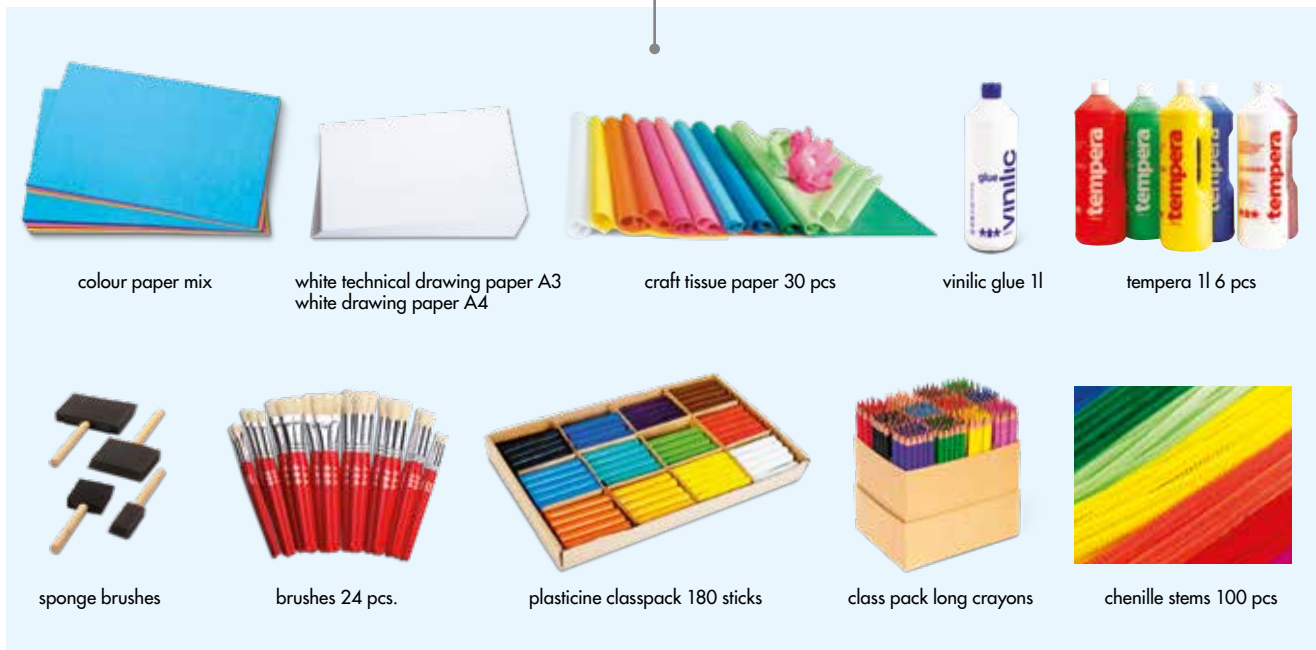

colour paper mix

white technical drawing paper A3
white drawing paper A4

craft tissue paper 30 pcs

vinilic glue 1l

tempera 1l 6 pcs

sponge brushes

brushes 24 pcs.

plasticine classpack 180 sticks

class pack long crayons

chenille stems 100 pcs

MULTIFUNCTIONAL MOBILE STAND

Universal stand for keeping rolled up vertical teaching aids, e.x.maps, boards or paper rolls. Equipped with wheels which are helpful in moving the stand with it's content.

- dim.: 72 x 65 x 84 cm;
- material: 18 mm furniture board in birch colour, 12 mm MDF board in white/green colour, white/green wire;
- 4 wheels

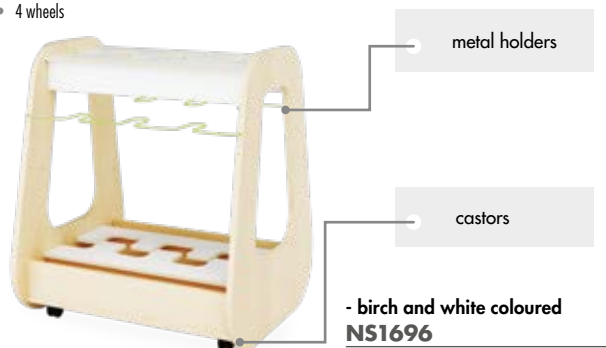

DRYERS

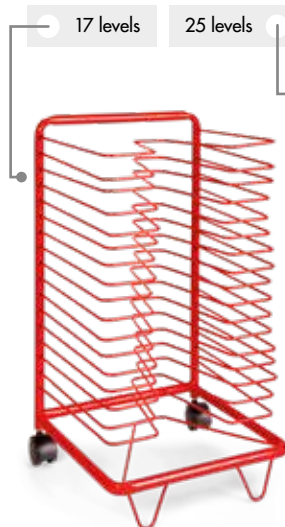

**Small-sized
MT5455**

- 17 levels;
- dim.: 43 x 33 x 65 cm



**Large-sized
MT5457**

- 25 levels;
- dim.: 43 x 33 x 90 cm

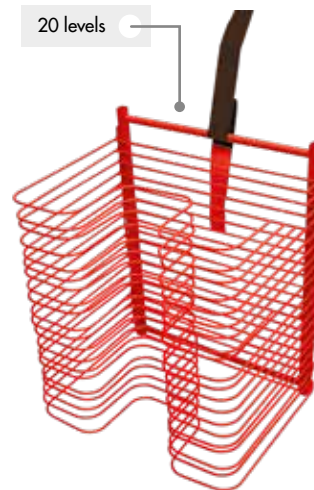

**Wall drying rack. Red
MT5460**

Wall drying rack for drying children's paintings.

- 20 levels;
- dim.: 50 x 40 x 62 cm

EASELS



Multipurpose stand NS0578

Serves as a play corner; with accessories can be used as a puppet theatre (NS0580).

- glass painting corner (NS0581) or market stall (NS0579);
- dim.: 84 x 51 x 113,5 cm

Glazed frame NS0581

Used with the multipurpose stand NS0578 to create an art corner.



Double easel NS1728

- double-sided, foldable, for 2 persons;
- 2 trays included;
- H 121 cm, boards 65 x 65 cm



**Four-person easel
NS1729**

- foldable, double-sided;
- accommodates 4 persons (4 trays);
- H 121 cm, boards dim.: 130 x 65 cm

4 trays
included



**Wall easel
NS0308**

- dim.: 198 x 108 x 17 cm;
- sold without trays



**Double-sided easel
NS0309**

- large-sized, double-sided, serves for 6 children;
- dim.: 200 x 70 x 95 cm
- sold without trays

TRAYS FOR EASEL



**3 trays for Wall easel
NS0314**

- size: 60 x 12 x 8 cm



**6 trays for Double-sided easel
NS0315**

- size: 60 x 12 x 8 cm

FOR COSTUMES



**Cubo mobile dress-up unit
NC8011**

This mobile cabinet for easy storage of theatre costumes has a bar for hangers and two top-open boxes for smaller elements of costumes.

- dim.: 120 x 50 x 120 cm;
- 2 boxes, bar, 5 castors (2 lockable);
- laminated particle board (birch), plastic, metal

bar for hangers

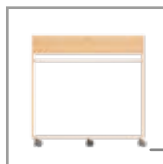

extra castor close to shlev

two top-open boxes
for smaller elements

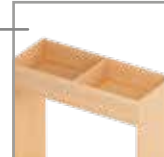

lockable castors

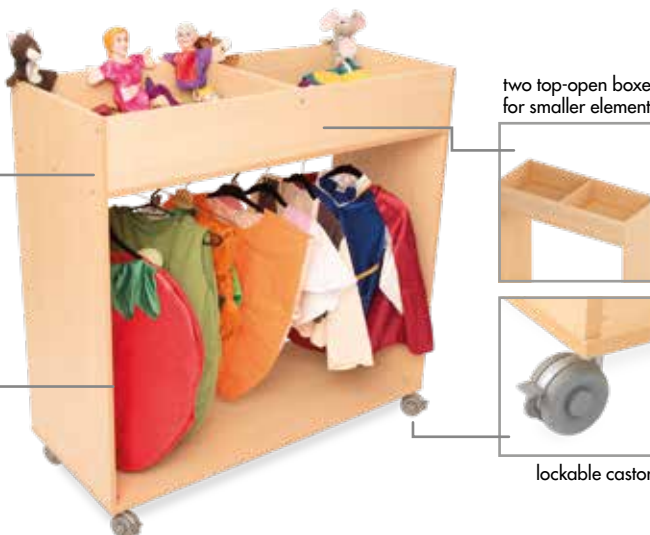

FOR SPORT ACCESSORIES



over 100
elements

on wheels

- without accesories

NS0943A

- without accesories
- dim.: 90 x 60 x 80 cm

- with accesories

NS0944A

- contains different accesories (13 types),
- dim.: 90 x 60 x 80 cm



FOR CONSTRUCTION BRICKS



8 types
of building blocks

1336 pieces



transparent plastic
trays with lids

4 castors



Mobile Storage unit with plastic containers and bricks NS4444

A mobile storage unit with 4 castors (2 with locks).

- 8 plastic containers with lids;
- 8 sets of bricks, 1336 pieces;
- cabinet size: 34 x 34 x 97 cm;
- containers in random colours (blue, green or white);
- all bricks come with worksheets which are available separately



Worksheets for building blocks NS4445

- set of worksheets for 7 types of building blocks;
- 168 cards;
- 3 sets of instructions for Morphon Junior Starter blocks;
- worksheets size: 11,5 x 11,5 cm



**Set of worksheets for mobile maxi cabinet
NS4447**

- 384 pcs: 24 worksheets in each set;
- worksheet size: 11,5 x 11,5 cm;
- every set is in cardboard packaging



Bricks sets included:

NS4004		NS4096	
NS4079		NS4016	
NS4112		NS4005	
NS4105		NS4007	
NS4100		NS4013	
NS4208		VO0786	
NS4098		NS4301	
NS4104		NS4106	

**Maxi mobile cabinet
with bricks and plastic containers
NS4446**

Mobile maxi cabinet made of birch-coloured laminated board. Transparent containers included in the set make maintaining order and hygienic storage of toys in kindergartens and school common rooms much easier. Rich selection of various types of bricks placed in separate containers is also included. It is suitable for group or individual work. Plastic wheels with a lock allow the user to quickly and easily move the furniture to the center of the room or to another place.

- dim.: 65,6 x 34,3 x 97,1 cm;
- 16 sets of bricks, 2041 pieces;
- material: birch-coloured laminated board, 18 mm thick, white furniture board, 12 mm thick;
- 16 transparent containers with plastic lids with dim.: 37 x 10 x 30 cm in green, blue, colorless;
- bricks sets: NS4004 Sprockets, NS4079 Connecting building blocks, NS4112 Basic blocks with printing, NS4105 Arrows, NS4100 Klik bricks, NS4208 Tower bricks, NS4098 Cubes, NS4104 Hedgehogs mobile, NS4096 Hexi, NS4016 Wraps, NS4005 People Acrobats, NS4007 Modules, NS4013 Windows, VO0786 Magnetic bricks, NS4301 Neopuzzle. Full figures and windows, NS4106 Molecules



**ECO. Storage cabinet with bricks and worksheets
NS4000**

- 8 large cardboard containers;
- 8 types of building blocks, over 1200 pieces;
- 8 sets of worksheets;
- cabinet made of chipboard laminated in birch colour size: 56 x 38 x 94 cm;
- over 1200 pieces



over 1200 pieces



8 types
of building blocks



8 sets
of worksheets

MAP HANGERS

You can store more than one map on the hooks. On the back of each map there are two labels with the name and type of the map. Thanks to this each one can be easily located and identified without the need of unrolling it.



**Map rack
ANW440**

- dim.: 100 x 55 x 130 cm

for 40 maps

Light practical stands are ideal for storing and presenting maps and wall charts, especially in schools and colleges. They help organize space functionally and economically. Wall racks help store in order maps and charts in large numbers and in perfect order. The stands are made of metal rods and profiles and fixed to a base with legs or on castors.

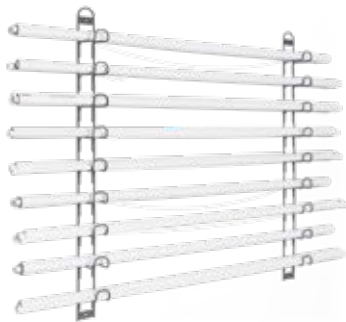

**Wall mounted
ANW200**

- 2 pcs; dim.: 8 x 13 x 120 cm;
- place for 18 maps



**Map stand
ANW600**

- height max.: 220 cm

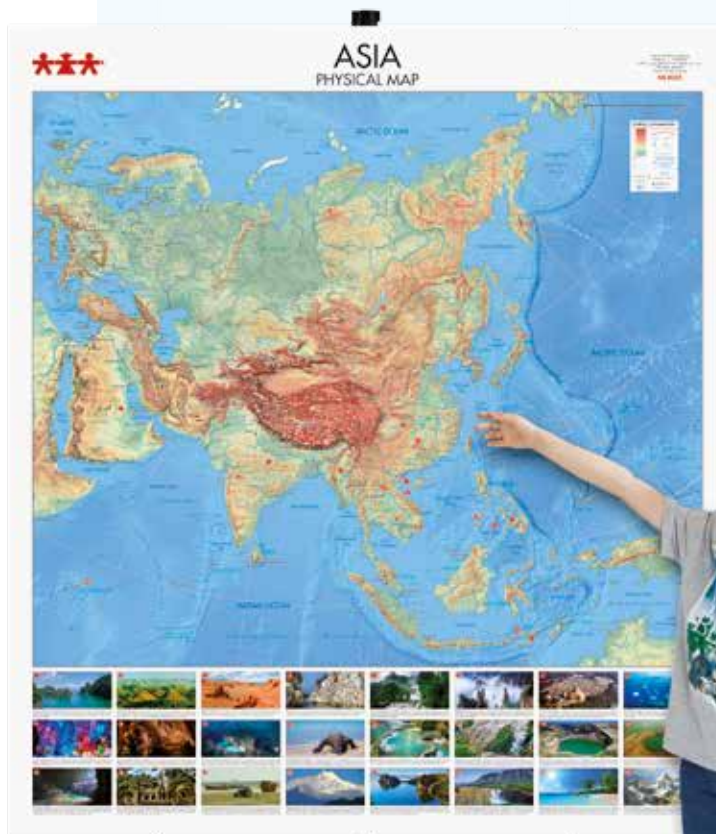

3D PRINTER CABINETS

3D print is slowly becoming a standard in schools. Thanks to this new technology of three-dimensional print, the process of learning is much more interesting and much easier to understand. To fully take advantage of the possibilities which 3D print provides, good quality accessories and a 3D printer are necessary. Among the selected products, you can find high quality filaments and a specially designed printer stand with a cabinet



Cabinet for 3D printers and filaments BAL0001

Cabinet for the printer and filaments. It is made of furniture board, 18 mm thick, in birch colour and MDF board, 12 mm thick, in grey colour. The stand is equipped with 6 deep plastic containers, 3 white and 3 grey, as well as a pair of doors

with a lock. Inside the stand, there are two shelves. 3 filament holders and 2 side limiters for the printer are placed on the back wall. Beige plastic legs, 5 pcs, can be replaced with furniture castors, sold separately – NJ0904.

- dim of the stand: 103,7 x 57 x 181,8 cm;
- tabletop height: 104 cm



Cabinet for 3D printers and filaments BAL0002

Cabinet made of birch and grey chipboard with three hooks for filaments. A pair of lockable doors. Lockable cabinet inside has a shelf. The furniture

has five legs for strength and stability of the structure. The set includes three plastic containers with lids in a color mix.

- dim.: 92 x 53,2 x 173 cm;
- top height: 101 cm

3D Printer available
on page 735



MANIPULATIVE CORNERS



Manipulative school bus NS9087

A bus made of plywood offering many options of creative and engaging manipulative play. Among the movable parts, there are colourful, big gears, colourful rotating elements with mirrors on the other side, differently shaped labyrinths, a steering wheel and

a gearbox. Additionally, the bus is equipped with textural fragments and mirrors. Inside, there is a comfortable and soft seat in grey colour attached with Velcro. This manipulative bus awakens curiosity in children thanks to the movable parts and it develops their imagination through playtime involving roleplay.

• dim.: 110 x 65 x 70 cm



Manipulative castle NS9088

A castle made of plywood offering many options of creative and engaging manipulative play. Among the movable parts, there are gears, an opening window with the possibility of closing it, rotating elements, differently shaped labyrinths

and a mesh above the castle's entrance. Additionally, the castle is equipped with textural fragments and mirrors which stimulate the sense of sight. This manipulative castle awakens curiosity in children thanks to the movable parts and it develops their imagination through playtime involving roleplay.

• dim.: 75 x 110 x 75 cm





Castle – manipulative walls
NS1717

A tower-shaped activity corner with 4 different panels on 4 walls: a flower with a safe mirror, a puzzle piece with a square maze, a puzzle piece with a triangular maze, a double-handed maze Snails.

- dim.: 72 x 72 x 134 cm

4 different panels
on 4 walls



**Manipulative mushroom with hat
NS0436**

A play corner in the form of a mushroom equipped with numerous manipulative accessories, such as spatial mazes, wooden blocks, laced tapestries and mirrors. You can hide under the hat or take

it off and put it on the floor, thus creating a mini-slide, or turn it upside down as a soft saucer to learn balance.

- dimensions: 120 x 120 x 130 cm;
- material: structure made of hardwood plywood 18 mm thick, hat made of polyurethane foam and PVC fabric, accessories made of PVC, metal, cotton fabric and wood

**Bear Interactive Kiosk
NS1716**

Multimedia kiosk is a bear-shaped stand for a tablet intended specially for children. The furniture will perfectly fill the space in play corners and provide educational entertainment for the youngest. The kiosk, equipped with an easy-to-use tablet, has been very carefully designed. The white framework is made of laminated chipboard, with the bear-shaped front made of MDF board.

- dim.: 90 x 40 x 130 cm



ROLE PLAY

WOODEN KITCHEN



MALUCH KITCHEN



**Workshop
NS0265**

A play corner for small do-it-yourselfers. The station is equipped with a wall with 3 small outlets and 12 large screw holes. On the tabletop there is a container in which work tools can be stored. The workshop has a lockable cabinet with two niches, on the other side there is space for 3 plastic containers. A vice was attached to the left side.

- set includes: table, 6 screws, attached vice, transparent plastic containers with lids 3 pcs in lime, blue and white;
- dim.: 56 x 38 x 78 cm;
- material: MDF board in mint color, chipboard in birch colour, additional elements made of wood;
- age: 3+



**Fridge
NS0264**

The fridge is divided into the deep-freeze (upper part) and the cooler. Both parts open independently.

- size: 38 x 36 x 78 cm



**Shelf unit
NS0262**

- size: 48 x 38 x 48 cm (58 cm with application)



**Washing Machine
NS0261**

- size: 48 x 38 x 48 cm (68 cm with application)



**Kitchen
NS0260**

- size: 68 x 38 x 48 cm (90 cm with application)



MINT KITCHEN



Mint kitchen shelves
NSO289

- dim.: 88 x 13 x 103 cm; type: standalone; the frame is made of 18 mm thick hardwood plywoo; the corner has got 2 chipboard shelves in birch colour, each 12 mm thick



Mint sink unit
NSO287

- dim.: 104 x 37 x 56 cm; unit with a plastic sink



Mint washing machine
NSO288

- dim.: 104 x 37 x 56 cm; additional wooden iron



Kitchen combo unit mint
NSO290

- dim.: 104 x 37 x 56 cm; 3 gas rings and openable oven



**Market stall
NS0465**

- dim.: 80 x 80 x 120 cm;
- made of pinewood varnished

**Market stall roof
NS0579**

- red denim;
- fits multipurpose stand NS0578

**Multipurpose stand
NS0578**

- serves as a play corner;
- made of chipboard laminated in beech colour;
- with accessories can be used as a puppet theatre (NS0580);
- glass painting corner (NS0581) or market stall (NS0579);
- dim.: 84 x 51 x 113,5 cm



**Market stall
NS1837**

- dim.: 123 x 82 x 81 cm;
- made of chipboard laminated;
- fabric roof

TABLES



EKOSTEEL

WITH METAL LEGS

A rich selection of table tops designed specifically to fit into school interiors. The presented styles differ by shape, size and colouring. When combined with metal legs (sold separately) of different heights, they create a comfortable workspace adjusted to the age and height of the user. Thanks to the special connecting elements (NTH0001), the table tops can be combined in various configurations. This solution guarantees freedom and comfort of work for many users. Each table top is made of laminated chipboard, 25 mm thick, with multiplex edge. In our offer, we present table tops in ten shapes and ten colours.

TYPE OF TABLE

tops and legs sold separately

AVAILABLE SHAPES OF TOPS

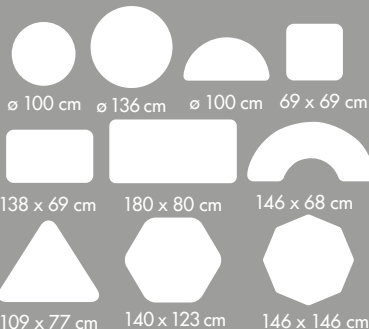

TOP

laminated board (25 mm)
top available in colours:



edges available in colours:

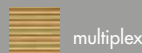

LEGS

non adjustable: 2 (53 cm), 3 (59 cm), 4 (64 cm), 5 (71 cm), 6 (76 cm)
regulated height: 1-3 (46-59 cm), 3-6 (59-76 cm)
metal
circular cross-section – \varnothing 48 mm

NORMS AND CERTIFICATES

PN-EN 1729-1:2007
INT CERT



only banana shape







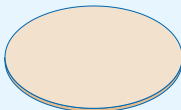

240
Legs available
on page

ROUND TOP

- ø 100 cm



- tabletop dim.: ø 100 cm; round-shaped;
- it is made of laminated chipboard, 25 mm thick, in white, red, blue, green, yellow, grey, mint, beech, birch colour, with 2 mm thick PVC edge banding in multiplex colour

white		NTH1000
red		NTH1001
blue		NTH1002
green		NTH1003
yellow		NTH1004
grey		NTH1005
mint		NTH1007
beech		NTH1008
birch		NTH1009







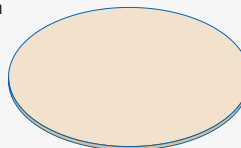



BIG ROUND TOP

- ø 136 cm



- tabletop dim.: ø 136 cm; round-shaped;
- it is made of laminated chipboard, 25 mm thick, in white, red, blue, green, yellow, grey, mint, beech, birch colour, with 2 mm thick PVC edge banding in multiplex colour

white		NTH3000
red		NTH3001
blue		NTH3002
green		NTH3003
yellow		NTH3004
grey		NTH3005
mint		NTH3007
beech		NTH3008
birch		NTH3009







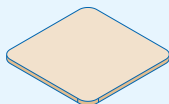



SQUARE TOP

- dim.: 69 x 69 cm



- tabletop dim.: 69 x 69 cm; square-shaped;
- it is made of laminated chipboard, 25 mm thick, in white, red, blue, green, yellow, grey, mint, beech, birch colour, with 2 mm thick PVC edge banding in multiplex colour

white		NTH4000
red		NTH4001
blue		NTH4002
green		NTH4003
yellow		NTH4004
grey		NTH4005
mint		NTH4007
beech		NTH4008
birch		NTH4009







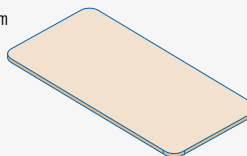



RECTANGULAR TOP

- dim.: 138 x 69 cm



- tabletop dim.: 138 x 69 cm; rectangular-shaped;
- it is made of laminated chipboard, 25 mm thick, in white, red, blue, green, yellow, grey, mint, beech, birch colour, with 2 mm thick PVC edge banding in multiplex colour









white		NTH2000
red		NTH2001
blue		NTH2002
green		NTH2003
yellow		NTH2004
grey		NTH2005
mint		NTH2007
beech		NTH2008
birch		NTH2009



BIG RECTANGULAR TOP

• dim.: 180 x 80 cm

- tabletop dim.: 180 x 80 cm; rectangular-shaped;
- it is made of laminated chipboard, 25 mm thick, in white, red, blue, green, yellow, grey, mint, beech, birch colour, with 2 mm thick PVC edge banding in multiplex colour

white		NTH7100
red		NTH7101
blue		NTH7102
green		NTH7103
yellow		NTH7104
grey		NTH7105
mint		NTH7107
beech		NTH7108
birch		NTH7109









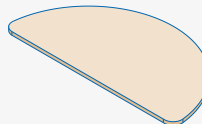

SEMI CIRCLE TOP

• dim.: 138 x 68 cm

- tabletop dim.: 138 x 68 cm; semicircle-shaped;
- it is made of laminated chipboard, 25 mm thick, in white, red, blue, green, yellow, grey, mint, beech, birch colour, with 2 mm thick PVC edge banding in multiplex colour











white		NTH9000
red		NTH9001
blue		NTH9002
green		NTH9003
yellow		NTH9004
grey		NTH9005
mint		NTH9007
beech		NTH9008
birch		NTH9009



TRIANGULAR TOP

• dim.: 109 x 77 cm

white		NTH7200
red		NTH7201
blue		NTH7202
green		NTH7203
yellow		NTH7204
grey		NTH7205
mint		NTH7207
beech		NTH7208
birch		NTH7209

- tabletop dim.: 109 x 77 cm; triangle-shaped;
- it is made of laminated chipboard, 25 mm thick, in white, red, blue, green, yellow, grey, mint, beech, birch colour, with 2 mm thick PVC edge banding in multiplex colour







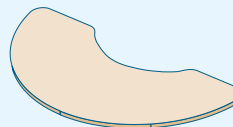





BANANA TOP

• dim.: 146 x 68 x 2,5 cm



- tabletop dim.: 146 x 68 x 2,5 cm;
- it is made of laminated chipboard, 25 mm thick, in white, red, blue, green, yellow, grey, mint, beech, birch, marine colour;
- banana-shaped with rounded edges;
- edge banding made of PVC, 1 mm thick, in multiplex colour

white		NTH5000
red		NTH5001
blue		NTH5002
green		NTH5003
yellow		NTH5004
grey		NTH5005
mint		NTH5007
beech		NTH5008
birch		NTH5009
marine		NTH5010



HEXAGONAL TOP

• dim.: 140 x 140 cm

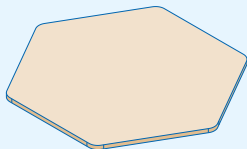

- tabletop dim.: 140 x 140 cm; hexagon-shaped;
- it is made of laminated chipboard, 25 mm thick, in white, red, blue, green, yellow, grey, mint, beech, birch colour, with 2 mm thick PVC edge banding in multiplex colour

white		NTH6000
red		NTH6001
blue		NTH6002
green		NTH6003
yellow		NTH6004
grey		NTH6005
mint		NTH6007
beech		NTH6008
birch		NTH6009



OCTAGONAL TOP

• dim.: 146 x 146 cm

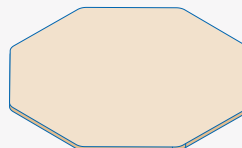

- tabletop dim.: 146 x 146 cm; octagon-shaped;
- it is made of laminated chipboard, 25 mm thick, in white, red, blue, green, yellow, grey, mint, beech, birch colour, with 2 mm thick PVC edge banding in multiplex colour

white		NTH8000
red		NTH8001
blue		NTH8002
green		NTH8003
yellow		NTH8004
grey		NTH8005
mint		NTH8007
beech		NTH8008
birch		NTH8009



PLYWOOD WITH HPL

LUX

Table top available in two sizes and shapes. It is made of plywood covered with a thermosetting and scratch-resistant HPL laminate resistant to chemical agents and high temperature. Edging varnished. The table will work perfectly in preschool classes, school canteens, biology and school laboratories. Height-regulated legs in the ranges 1-3 (NS0067) and 3-6 (NS0079) sold separately.



**Lux table top – square
LUX004**

- dim.: 80 x 80 cm; material: HPL plywood, 25 mm, beech coloured, PVC rims



**Lux table top – rectangular
LUX005**

- dim.: 80 x 120 cm; material: HPL plywood, 25 mm, beech coloured, PVC rims



METAL LEGS

A collection of metal legs with a diameter of 45 mm. Available range of height regulations: 1-3 and 3-6 or 5 heights. Their durable steel construction and connecting elements guarantee firmness and comfort of use. Angled legs (5 degrees) provide extra stability. The legs were additionally equipped with non-slip furniture pads made of plastic to protect the floor. This set of table legs combined with our selection of tabletops allows you to create functional school interiors. The given dimensions reflect the height of the table after the installation of legs.

IN SEVERAL HEIGHTS

- 4 pcs; material: metal



**size 2
TH0002**

- height of the table: 53 cm

**size 3
TH0003**

- height of the table: 59 cm

**size 4
TH0004**

- height of the table: 64 cm

**size 5
TH0005**

- height of the table: 71 cm

**size 6
TH0006**

- height of the table: 76 cm

WITH ADJUSTMENT



for triangular
top table

**3 metal legs with 1-3 regulation
NS0081**

- with height regulation 1-3; 46-53-59 cm

**3 metal legs with 3-6 regulation
NS0083**

- with height regulation 3-6; 59-64-71-76 cm



**4 metal legs with 1-3 regulation
NS0067**

- height: 46 - 53 - 59 cm

**4 metal legs with 3-6 regulation
NS0079**

- height: 59 - 64 - 71 - 76 cm,
- they go well with the table top NS3723



for hexagonal
top table

**6 metal legs with 1-3 regulation
NS0069**

- height: 46 - 53 - 59 cm

**6 metal legs with 3-6 regulation
NS0080**

- height: 59 - 64 - 71 - 76 cm



CONNECTORS FOR TABLES



Connecting elements for conference tables NTH0001

Special connecting elements for joining tabletops together. They allow you to create many different table configurations in order to provide more working space. The connecting elements should be attached to the underside of the tabletops to ensure stability and to prevent the tables from sliding apart.

- 2 pcs; dim.: 28 x 14,2 cm; table fittings;
- material: MDF board, 12 mm thick, in white colour

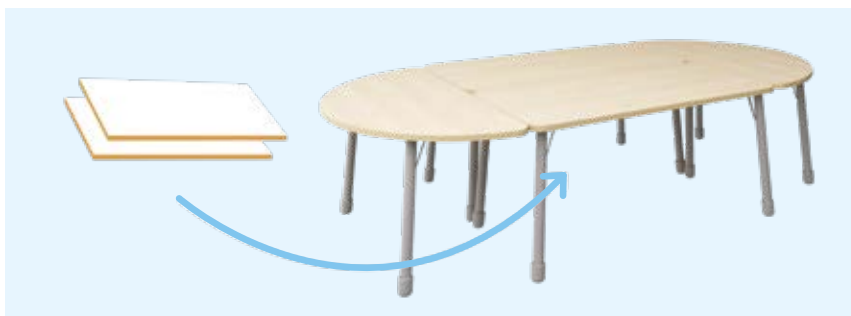

CREATE YOUR OWN CONFIGURATION

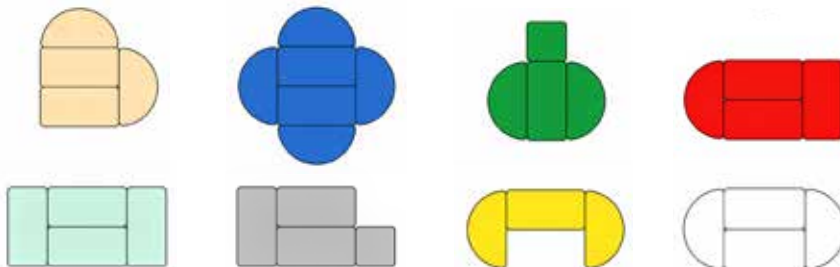

TOP TABLES FOR WOODEN LEGS

A wide range of multi-seater tabletops in different shapes and colours. They create a functional space for individual or group work. The edges are rounded and finished with a classy PVC edge banding tape. All tabletops can be easily combined to fit into any interior or to complement any work style. Underneath, there is a base which ensures the stability of the table. Tabletops and legs are sold separately.

AVAILABLE SHAPES OF TOPS



75 x 75 cm 120 x 75 cm ø 90 cm ø 138 cm

TOPS AVAILABLE IN COLOURS



EDGES AVAILABLE IN COLOURS



TOP

laminated board (D18 mm) with plinth

NORMS AND CERTIFICATES

PN-EN1729-1:2016-02
PN-EN1729-2:+A12016-02
INT CERT



The corner bracket allows you to safely and functionally connect the elements of the table, ensuring stability and durability.



Legs sold separately





RECTANGULAR TOP

- W 120 cm;
- D 75 cm;
- H 40-71 cm

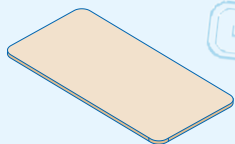

LEGS SOLD SEPARATLY



Colour edge & colour top

blue		NS2740NI
red		NS2740CZ
green		NS2740ZI
yellow		NS2740ZL
white		NS2740/B

Colour edge & wooden colour top

blue		NS2723NI
red		NS2723CZ
green		NS2723ZI
yellow		NS2723ZL
multiplex		NS2723/M



SQUARE TOP

- W 75 cm;
- D 75 cm;
- H 40-71 cm

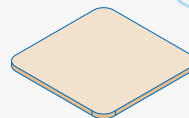

LEGS SOLD SEPARATLY



Colour edge & colour top

blue		NS2741NI
red		NS2741CZ
green		NS2741ZI
yellow		NS2741ZL
white		NS2741/B

Colour edge & wooden colour top

blue		NS2724NI
red		NS2724CZ
green		NS2724ZI
yellow		NS2724ZL
multiplex		NS2724/M



ROUND TOP

- ø 90 cm;
- H 40-71 cm

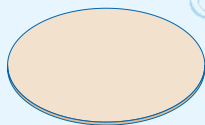

LEGS SOLD SEPARATLY



Colour edge & colour top

blue		NS2742NI
red		NS2742CZ
green		NS2742ZI
yellow		NS2742ZL
white		NS2742/B

Colour edge & wooden colour top

blue		NS2725NI
red		NS2725CZ
green		NS2725ZI
yellow		NS2725ZL
multiplex		NS2725/M



HEXAGONAL TOP

- ø 143 cm;
- H 40-71 cm

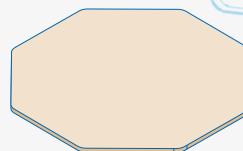

LEGS SOLD SEPARATLY



Colour edge & colour top

blue		NS2795/NI
red		NS2795/CZ
green		NS2795/ZI
yellow		NS2795/ZL
white		NS2795/B

Colour edge & wooden colour top

blue		NS2796/NI
red		NS2796/CZ
green		NS2796/ZI
yellow		NS2796/ZL
multiplex		NS2796/M



WOODEN LEGS

CLASSIC

Round wooden table legs with height regulation thanks to which the table can be adjusted to the height of the user. Functional and easy to mount nuts allow you to choose from four or two height levels. Regulation ranges from 0 to 3 are suited for children up to 10 years old while those of 3 to 4 are perfect for

primary school students. Tabletops and legs are sold separately.

- regulated height 0 – 4 (40, 46, 53, 59, 64 cm);
- varnished beech wood;
- circular cross-section – ø 48 mm;
- top mounting;
- the height can be adjusted by loosening or tightening the nuts

COMBITABLE SYSTEM

one leg - 4 heights
size 0-3

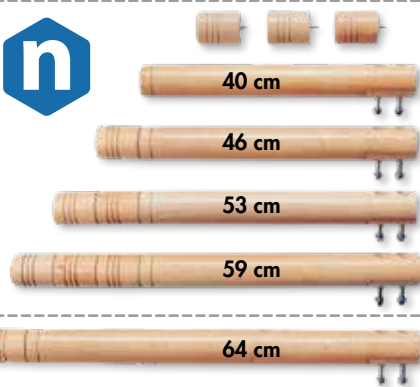

applies to school
table height

4 leg set

ST1000 size 0-3 (40-59 cm)

ST1001 size 3-4 (58-64 cm)

6 leg set

ST1002 size 0-3 (40-59 cm)

ST1003 size 3-4 (58-64 cm)



ERGO

Trapezoidal table legs are made of varnished beech wood. They are available in 7 different height levels: 0 (40 cm), 1 (46 cm), 2 (53 cm), 3 (59 cm), 4 (64 cm), 5 (71 cm), 6 (76 cm). This feature allows them to be adjusted to the height of the user while ensuring stability of the table. Tabletops and legs are sold separately.



- with a trapezoidal cross-section



4 leg set

NS0040 height 0 (40 cm)

NS0046 height 1 (46 cm)

NS0053 height 2 (53 cm)

NS0059 height 3 (59 cm)

NS0064 height 4 (64 cm)

NS0071 height 5 (71 cm)

NS0076 height 6 (76 cm)

6 leg set

NS6040 height 0 (40 cm)

NS6046 height 1 (46 cm)

NS6053 height 2 (53 cm)

NS6059 height 3 (59 cm)

NS6064 height 4 (64 cm)

NS6071 height 5 (71 cm)

NS6076 height 6 (76 cm)

READY TABLES WITH CLASSIC LEGS

TRAPEZOIDAL

- W 110 cm;
- D 63 cm;
- H 40-58 cm

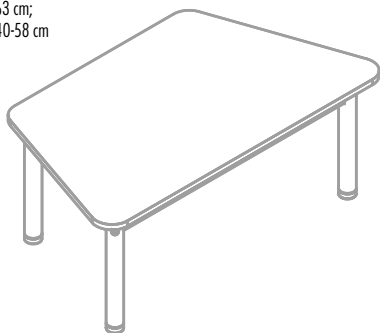

COLOUR EDGE & COLOUR TOP

- NS0738NI
- NS0738CZ
- NS0738ZI
- NS0738ZL



WHITE EDGE & WHITE TOP

- NS0738B



COLOUR EDGE & WOODEN COLOUR TOP

- NS0739NI
- NS0739CZ
- NS0739ZI
- NS0739ZL



EDGE MULTIPLEX & WOODEN TOP

- NS0739MU



RECTANGULAR WITH CONTAINER



hidden container

height adjustable legs

Table with container NS0565

The central part of the top hides a container for small objects necessary in art & craft activities.

- dim.: 120 x 80 cm, 3 H: 46, 52, 58 cm;
- hidden container



FOLDING TABLES

SLIM



top protection when folded in grey



Slim Folding table - HPL laminated chipboard NS7600

Table equipped with a large worktop made of HPL laminated chipboard and with rim, beech coloured. Solid metal base with folding function makes storing and transport easy. Fasteners protect the table top against bending and uncontrolled folding. It is perfect for common rooms, dining rooms and outdoor events.

- dim.: 180 x 76 x 76 cm;
- material: table top made of HPL laminated chipboard, 18 mm thick, frame made of metal profiles with dim.: 28 x 1,5 mm (round) i 30 x 30 x 1,5 mm (square) powder coated in grey

Ergonomic and comfortable Slim table holder. Thanks to this solution, you can quickly and efficiently move the Slim tables from place to place as well as safely store them while saving space. The mounted wheels allow mobility, and the possibility of locking them, ensures safety.

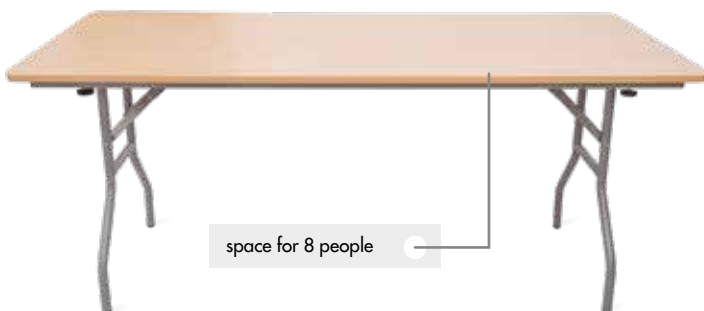

space for 8 people

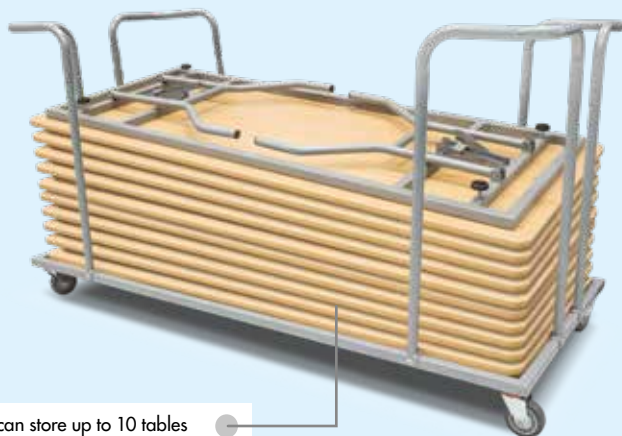

can store up to 10 tables

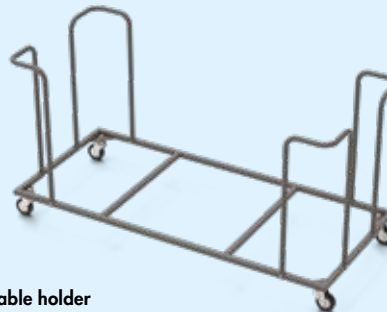

Slim table holder NS7650

- table holder „Slim“ equipped with four wheels, two of them with breaks;
- material: metal; colour: grey; it can store up to 10 tables; dim.: 83 x 187 x 86 cm



Slim Folding table – plastic NS7700

Light and practical table equipped with a big table top made of high-quality synthetic material which is resistant to mechanical and chemical damage as well as high temperature. It's solid construction with folding function is based on a metal frame that ensures stability. A special lock prevents accidental folding during use. This table is simple to use. When folded, it takes up little space and is easy to store. It will work perfectly during parties or outdoors classes.

- dim.: 180 x 74 x 74 cm
- material: top made of high-density polyethylene, frame made of tubes, dim.: 25 x 1 mm, powder coated



lock prevents
accidental folding
during use



non-scratching
footers



simple to fold



lock after
unfolding table



Slim Chair stand NS7501

Mobile stand with a metal frame for storing and transporting Slim chairs. Equipped with four wheels, including two with a brake. They can store a maximum of 10 chairs.

- dim.: 45 x 74 x 121 cm



Slim Folding chair NS7500

This practical and functional chair has foldable frame, making it easy to hide when not in use. It doesn't take up too much space. Stable and light construction, easy to fold and move to another place, makes it a perfect solution when an additional place to sit is needed or when the space has to be rearranged because of a given activity. Ideally suited to multi-functional rooms. The backrest and seat are made of HPL laminated plywood. The frame of the chair is made of round metal profiles with plastic gliders to prevent scratching the floor.

- dim.: 44,5 x 48,8 x 82,5 cm; material: the seat and the backrest are made of plywood, 8 mm thick, covered with HPL laminate; the frame of the chair is made of metal profiles: 22 x 1,2 mm and 16 x 1,2 mm, powder coated in grey

KANTYNA

Remarkably practical mobile tables with benches or seats. An ideal solution for educational institutions and wherever quick working or eating space is

required. Quick, tool-free assembly. Equipped with castor wheels for safe and easy transportation. When folded, they take up little space, which makes storage

easier. The metal framework is powder painted. The seat legs are protected with plastic ferrules.



12 seats

Rectangular mobile folding table seating unit NS7800

- dim.: 364 x 146 x 76 cm; rectangular top dim.: 180 x 75 cm; 12 seats H 43,5 cm; materials: plastic, steel, 18 mm MDF with PVC edging

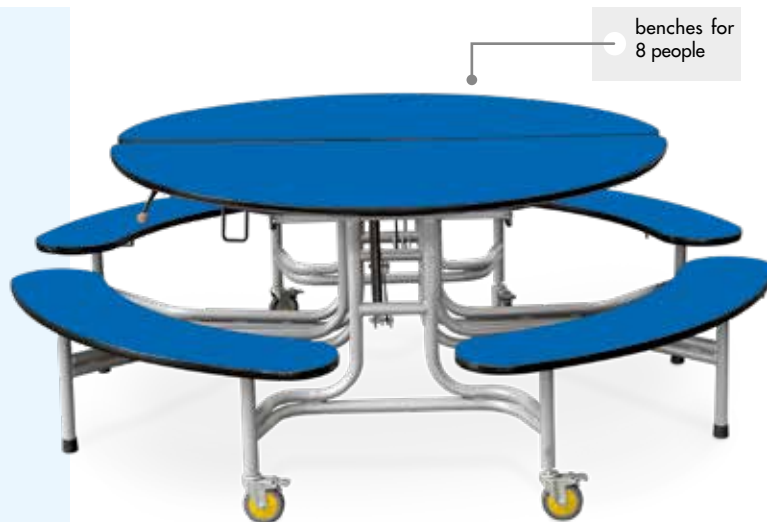

benches for
8 people

Round mobile folding table seating unit NS7900

- dim.: 150 x 76 cm; round top 150 x 73 cm; benches for 8 people, H 43,5 cm; material: plastic, steel, laminated plywood 25 mm thick

HPL TOP

HPL laminate



HPL laminate

The top is made of 18 mm HPL laminated chipboard in beech effect. HPL is a thermosetting scratch-, crash-, heat- and chemical-resistant material, and as such is ideal in school canteens. The frame and legs are made of 40 x 40 mm grey metal tubes. Height adjustable.

HPL table 4 NS0062

- dim.: 80 x 120 cm, H 64 cm

HPL table 6 NS0063

- dim.: 80 x 120 cm, H 76 cm

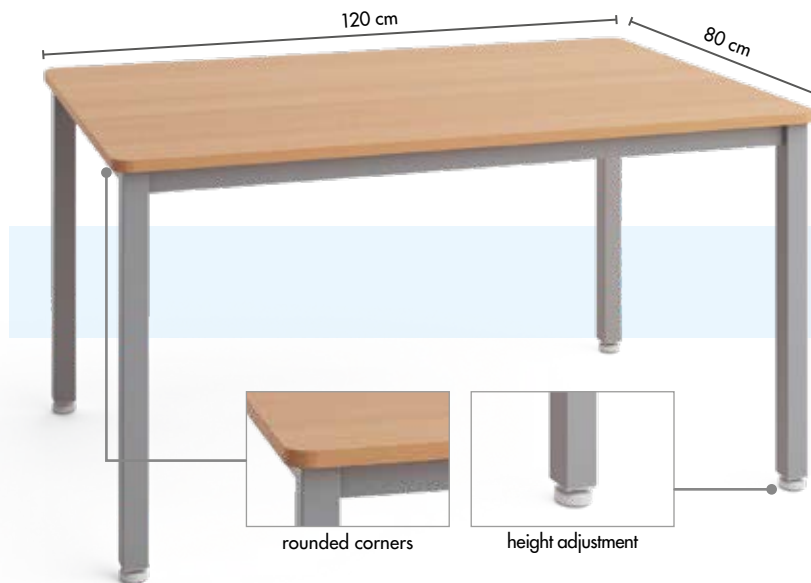

PLASTIC TOP METAL LEGS

BUTTERFLY

Comfortable tables for children distinguished by their practical form and elegant shape. Solid tabletop with rounded edges guarantees safety during playtime. Ours tabletops are made of plastic reinforced with a metal frame and metal legs with regulated height: 40-60 cm (height 0-3). Non-slip plastic furniture pads protect the floor from scratches. Butterfly chairs, available in matching shapes and sizes, are a perfect addition to these tables.

- dim.: 62 x 62 cm; available colours: red, blue, green, grey, yellow (only square and rectangular)

TYPE OF TABLE

complete - tables - tops with legs

TOPS AVAILABLE IN COLOURS



TOP

- PVC (Ø 40 mm)

LEGS

- adjustable height 0 – 3 (40, 46, 53, 59 cm)
- metal
- circular cross section - Ø 48 mm



metal frame for durability



height adjustment
40-59 cm (0-3)



corners rounded for safety



non-scratch non-slip ferulers

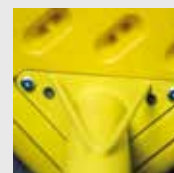

metal braces for reinforced attachment

SQUARE TABLE

height adjustment (40-59 cm)

TOP SIZE

62 x 62 cm



TABLE RECTANGULAR

height adjustment (40-59 cm)

TOP SIZE

62 x 122 cm

YC9025YC9021YC9022YC9023YC9024the tables connect
with butterfly chairs**TABLE ISLAND**

height adjustment (40-59 cm)

TOP SIZE

105 x 150 cm

YC9032YC9033YC9031YC9035

SCHOOL DESKS

CLASSICAL

TYPE OF TABLE

complete tables

AVAILABLE SHAPES OF TABLE TOPS



130 x 50 cm



69 x 50 cm

TOPS, SEATS AND BACKREST AVAILABLE IN COLOURS



beech

LEGS AND FRAME AVAILABLE IN COLOURS



TABLE TOP

- chipboard (gr. 18 mm)
- top fixing - frame double-reinforced with corners and bars

TABLE LEGS

- nonadjustable height: 3 (59 cm), 4 (64 cm), 5 (71 cm), 6 (76 cm)
- metal
- square cross-section - 25 mm

ADDITIONAL ACCESORIES

plastic hooks for bags

NORMS AND CERTIFICATES

INT CERT

PN-EN 1729-1:2016-02
PN-EN 1729-2:+A1:2016-02



SINGLE TABLE

height 3 (59 cm)

AJE130

height 4 (64 cm)

AJE140

height 5 (71 cm)

AJE150

height 6 (76 cm)

AJE160

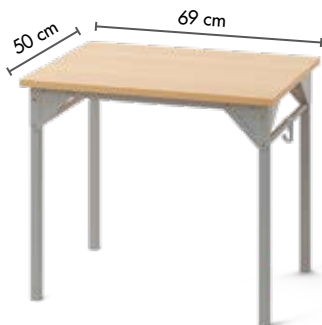

DOUBLE TABLE

height 3 (59 cm)

AJE230

height 4 (64 cm)

AJE240

height 5 (71 cm)

AJE250

height 6 (76 cm)

AJE260

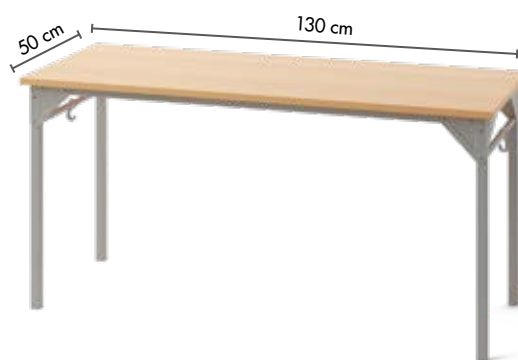



SEATS AND BACKRES AVAILABLE IN COLOURS



beech

LEGS AND FRAME AVAILABLE IN COLOURS



SEATS AND BACKREST

plywood with HPL

CHAIR LEGS

- nonadjustable height:
3 (35 cm), 4 (38 cm), 5 (43 cm), 6 (46 cm), 7 (51 cm)
- metal
- curcuk cross-section - 25 mm

NORMS AND CERTIFICATES

INT CERT

PN-EN 1729-1:2016-02
PN-EN 1729-2:+A1:2016-02

CHAIRS



height 3
NS0013

- seat height 35 cm

height 4
NS0014

- seat height 38 cm

height 5
NS0015

- seat height 43 cm

height 6
NS0016

- seat height 46 cm

height 7
NS0017

- seat height 51 cm





HEIGHT ADJUSTABLE

TYPE OF TABLE

complete tables

AVAILABLE SHAPES OF TOPS

2 students

1 student

120 x 50 cm

60 x 50 cm

TOPS, SEAT AND BACKRES AVAILABLE IN COLOURS



beech

FRAME AVAILABLE IN COLOURS



TABLE TOP

- plywood laminated with HPL (gr. 18 mm)

METAL TABLE LEGS

- height adjustment 2 – 4 (53, 59, 64 cm) 3 – 6 (59, 64, 71, 76 cm)
- metal

ADDITIONAL ACCESSORIES

basket for tables,
hook for bags (sold separately)

SEAT AND BACKRES OF CHAIRS

plywood laminated with HPL

NORMS AND CERTIFICATES

PN-EN 1729-1:2007
INT CERT

ACCESORIES



**Bag hook for the school desk
NS0052**



**Basket for books
NS0058**

- dim.: 45 x 34 x 12 cm, 1 pc;
- fits 1 and 2 person desk



ONE STUDENT

Adjustable desk 2-4

- height-adjustable 2-4 (53 – 59 – 64 cm)



- top dim.: 60 x 50 x 1,8 cm; top colour: beech

Adjustable desk 3-6

- height-adjustable 3-6 (59 – 64 – 71 – 76 cm)



TWO STUDENTS

Adjustable desk 2-4

- height-adjustable 2-4 (53 – 59 – 64 cm)



- top dim.: 120 x 50 x 1,8 cm; top colour: beech

Adjustable desk 3-6

- height-adjustable 3-6 (59 – 64 – 71 – 76 cm)



HEIGHT AND DESK ADJUSTABLE



Single school desk with tilted tabletop and height regulation 3-6 NS2749

Single desk with the possibility of tilting the tabletop in the range from 0 to 15 degrees.

- dim.: 70 x 50 cm;
- tabletop's height regulation: 59-76 cm;
- table top made of 18 mm laminated MDF in beech colour;
- metal frame and legs, powder coated grey



adjustable height
and angle top



safety barrier
sliding objects





ADJUSTABLE CHAIRS

height 1-2 26 – 31 cm



• dim.: 32,5 x 34 x 65 cm



height 3-4 35 – 38 cm



• dim.: 38,5 x 40 x 74 cm



height 5-6 43 – 46 cm



• dim.: 41,5 x 48 x 85 cm



SEAT AND BACKRES COLOURS



beech

FRAME AVAILABLE IN COLOURS



SEAT AND BACKREST OF CHAIRS

plywood laminated with HPL

NORMS AND CERTIFICATES

PN-EN 1729-1:2007 \ INT CERT



ASO

ASO DESK

High-quality single, double and triple desks in sizes 3, 4, 5, 6 and 7. The tops with safe rounded corners are made of durable 18 mm HPL laminated chipboard in beech effect.

HPL is a thermosetting scratch-, crash-, heat- and chemical-resistant material, and as such is an ideal option with older pupils in school labs or biology workshops.

The top comes in three sizes: single (69 x 50 cm), double (130 x 50 cm) and triple (180 x 50 cm). The framework and legs are made of steel square tubing 40 x 40 mm painted grey. Level adjustment.

HPL laminate



chipboard

HPL laminate



SINGLE DESK

- desk top dim.: 69 x 50 cm

Size 3

ASO1300

- height 3 (59 cm)

Size 4

ASO1400

- height 4 (64 cm)

Size 5

ASO1500

- height 5 (71 cm)

Size 6

ASO1600

- height 6 (76 cm)

Size 7

ASO1700

- height 7 (82 cm)



DOUBLE DESK

- desk top dim.: 130 x 50 cm

Size 3

ASO2300

- height 3 (59 cm)

Size 4

ASO2400

- height 4 (64 cm)

Size

ASO2500

- height 5 (71 cm)

Size 6

ASO2600

- height 6 (76 cm)

Size 7

ASO2700

- height 7 (82 cm)





backpack hanger



durable metal frame



level adjustment

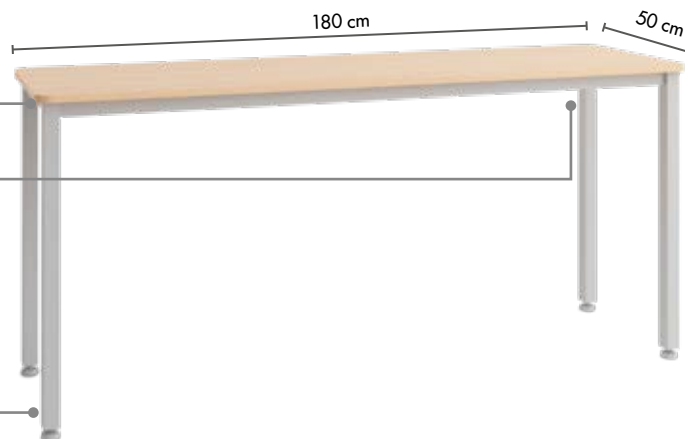

TRIPLE DESK

- desk top dim.: 180 x 50 cm

Size 6

ASO3600

- height 6 (76 cm)

Size 7

ASO3700

- height 7 (82 cm)

WORKBENCHES

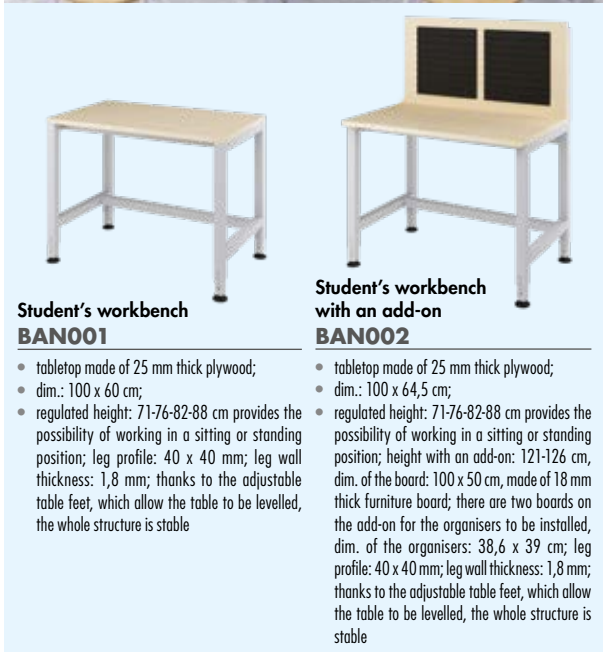

Student's workbench BAN001

- tabletop made of 25 mm thick plywood;
- dim.: 100 x 60 cm;
- regulated height: 71-76-82-88 cm provides the possibility of working in a sitting or standing position; leg profile: 40 x 40 mm; leg wall thickness: 1,8 mm; thanks to the adjustable table feet, which allow the table to be levelled, the whole structure is stable

Student's workbench with an add-on BAN002

- tabletop made of 25 mm thick plywood;
- dim.: 100 x 64,5 cm;
- regulated height: 71-76-82-88 cm provides the possibility of working in a sitting or standing position; height with an add-on: 121-126 cm, dim. of the board: 100 x 50 cm, made of 18 mm thick furniture board; there are two boards on the add-on for the organisers to be installed, dim. of the organisers: 38,6 x 39 cm; leg profile: 40 x 40 mm; leg wall thickness: 1,8 mm; thanks to the adjustable table feet, which allow the table to be levelled, the whole structure is stable

Tables perfect for every studio or workshop. The tabletops are made of a thick, durable plywood which ensures stability and sturdiness of the construction. Thanks to the regulated height of the legs, you can work standing or sitting. These tables are universal, and they will prove useful during many workshop activities.



Teacher's workbench BAN003

- tabletop made of 25 mm thick plywood;
- dim.: 150 x 60 cm;
- regulated height: 71-76-82-88 cm provides the possibility of working in a sitting or standing position;
- leg profile: 40 x 40 mm;
- leg wall thickness: 1,8 mm;
- thanks to the adjustable table feet, which allow the table to be levelled, the whole structure is stable

Teacher's workbench with an add-on BAN004

- tabletop made of 25 mm thick plywood;
- dim.: 150 x 64,5 cm;
- regulated height: 71-76-82-88 cm provides the possibility of working in a sitting or standing position; height with an add-on: 121-126 cm, dim. of the board: 100 x 50 cm, made of 18 mm thick furniture board; there are four boards on the add-on for the organisers to be installed; two boards with the dim.: 38,6 x 39 cm and two boards with the dim.: 38,6 x 13 cm;
- leg profile: 40 x 40 mm; leg wall thickness: 1,8 mm; thanks to the adjustable table feet, which allow the table to be levelled, the whole structure is stable





Workbench ARN0001

- dim.: 200 x 63,3 x 75,5 cm;
- school workbench made of 18 mm and 25 mm thick chipboard in grey colour;
- tabletop is made of plywood, 18 mm thick, back plinth of the tabletop is made of plywood, 18 mm thick and 12 mm high;
- the workbench is equipped with: doors closed with a lock, aluminium handles, drawers, 4 pcs: 3 drawers with central locking are placed on the left side;
- 1 shelf without a lock is placed in the central part under the tabletop



LAB WORKSTATION

Our lab furniture is the ideal solution for school science labs. It is manufactured using modern technology and it meets standards for educational institutions. The worktops are made of specialist high-quality 25 mm board resistant most chemicals, mainly acids. The material is also highly resistant to scratching, hard knocks, abrasion, stains, moisture as well as extreme temperatures. The work stations and the lab table are made of laminated

18 mm chipboard in beech finish and mounted on 13 cm pedestal on a slide for stability. The cream worktop and the beech body make an aesthetic colour combination and are easy to clean. In response to the demand from schools the work stations come in two sizes equipped with large and small sinks as well as taps. The series also includes a pupil table with two cabinets (one on each side).

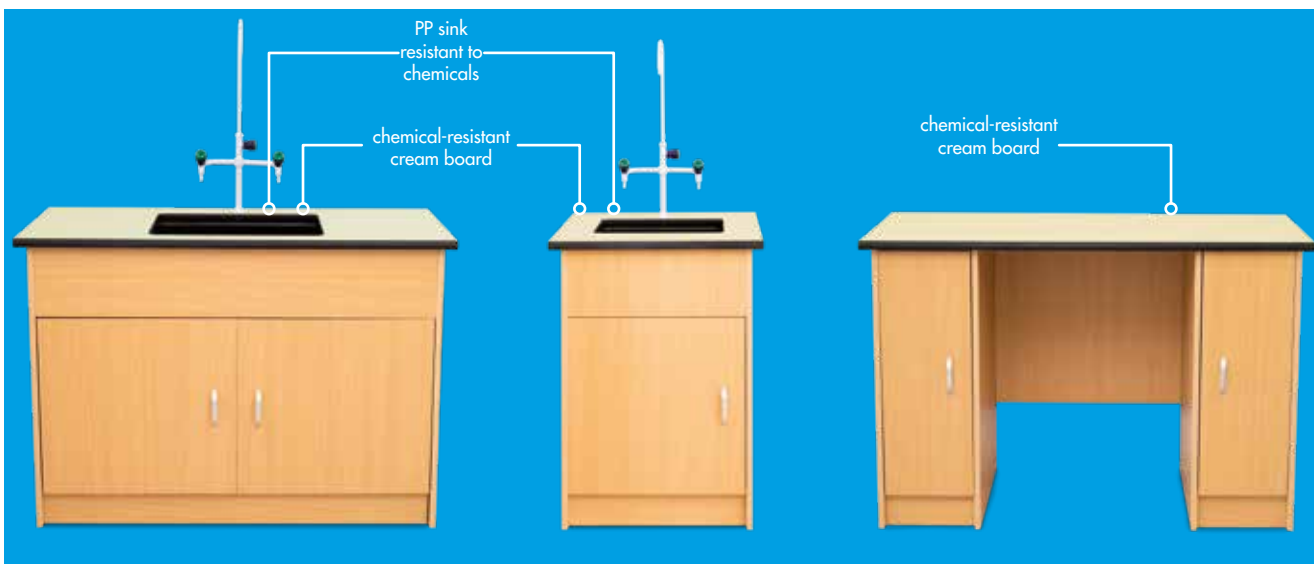

Lab workstation (large) NS3233

A lab workstation for heavy physical and chemical apparatus. The PP sink (48.5 x 38.5 cm) with a tap is also resistant to chemicals and is inset into the worktop. The body is made of laminated 18 mm chipboard in beech effect.

- dim.: 120 x 60 x 85 cm;
- the worktop made of high-quality chemical-resistant cream 25 mm board

Lab workstation (small) NS3234

The worktop is made of high-quality chemical-resistant cream 25 mm board. The PP sink (38 x 28 cm) with a tap is also resistant to chemicals and is inset into the worktop. The body is made of laminated 18 mm chipboard in beech effect.

- dim.: 60 x 60 x 85 cm

Pupil lab table NS3235

A pupil lab table equipped with two cabinets (one on each side). Very durable and functional. The worktop is made of high-quality chemical-resistant cream 25 mm board. The PP sink (38 x 28 cm) with a tap is also resistant to chemicals and is inset into the worktop. The body is made of laminated 18 mm chipboard in beech effect.

- dim.: 125 x 60 x 85 cm



KAROLEK

TYPE OF CHAIR

multielement (metal and plywood)

AVAILABLE SEAT COLOURS



beech

AVAILABLE LEG COLOURS



SEAT AND BACKREST

- beech plywood (gr. 8 mm)

LEGS

- nonadjustable
 - 0 (21 cm),
 - 1 (26 cm),
 - 2 (31 cm),
 - 3 (35 cm),
 - 4 (38 cm),
 - 5 (43 cm),
 - 6 (46 cm)
- metal
- round cross-section [0,1,2 - ø 19 mm], [3,4,5,6 - ø 22 mm]
- stackable

NORMS AND CERTIFICATES

PN-EN 1729-1:2016-2

PN-EN 1729-2:+A1:2016-02

INT CERT

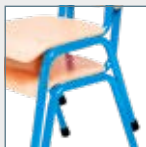

CHAIRS





- 0**
- NS0746B White
 - NS0746NI Blue
 - NS0746ZI Green
 - NS0746ZL Yellow
 - NS0746CZ Red



- 1**
- NS1774B White
 - NS1774NI Blue
 - NS1774ZI Green
 - NS1774ZL Yellow
 - NS1774CZ Red



- 2**
- NS2775B White
 - NS2775NI Blue
 - NS2775ZI Green
 - NS2775ZL Yellow
 - NS2775CZ Red



- 3**
- NS3776B White
 - NS3776NI Blue
 - NS3776ZI Green
 - NS3776ZL Yellow
 - NS3776CZ Red



- 4**
- NS4777B White
 - NS4777NI Blue
 - NS4777ZI Green
 - NS4777ZL Yellow
 - NS4777CZ Red



- 5**
- NS5778B White
 - NS5778NI Blue
 - NS5778ZI Green
 - NS5778ZL Yellow
 - NS5778CZ Red

- 6**
- NS6779SZ Grey



CLASSIC

SEATS AND BACKREST AVAILABLE IN COLOURS



beech

LEGS AND FRAME AVAILABLE IN COLOURS



SEATS AND BACKREST

plywood with HPL

CHAIR LEGS

- nonadjustable height:
3 (35 cm), 4 (38 cm), 5 (43 cm), 6 (46 cm), 7 (51 cm)
- metal
- curcke cross-section - 25 mm

NORMS AND CERIFICATES

INT CERT

PN-EN 1729-1:2016-02

PN-EN 1729-2:+A1:2016-02



School desks
available on page 254



Height 3 NS0013

- seat Height 35 cm

Height 4 NS0014

- seat Height 38 cm

Height 5 NS0015

- seat Height 43 cm

Height 6 NS0016

- seat Height 46 cm

Height 7 NS0017

- seat Height 51 cm





HEIGHT ADJUSTABLE

height 1-2 26 – 31 cm



• dim.: 32,5 x 34 x 65 cm



height 3-4 35 – 38 cm



• dim.: 38,5 x 40 x 74 cm



height 5-6 43 – 46 cm



• dim.: 41,5 x 48 x 85 cm



School desks
available on page 256



SEAT AND BACKREST COLOURS



beech

FRAME AVAILABLE IN COLOURS



SEAT AND BACKREST OF CHAIRS

plywood laminated with HPL

NORMS AND CERIFICATES

PN-EN 1729-1:2007 \ INT CERT



FOLDING



Slim Folding chair
NS7500

This practical and functional chair has foldable frame, making it easy to hide when not in use. It doesn't take up too much space. Stable and light construction, easy to fold and move to another place, makes it a perfect solution when an additional place to sit is needed or when the space has to be rearranged because of a given activity. Ideally suited to multi-functional rooms. The backrest and seat are made of HPL laminated plywood. The frame of the chair is made of round metal profiles with plastic gliders to prevent scratching the floor.

- dim.: 44,5 x 48,8 x 82,5 cm;
- material: the seat and the backrest are made of plywood, 8 mm thick, covered with HPL laminate;
- the frame of the chair is made of metal profiles: 22 x 1,2 mm and 16 x 1,2 mm;
- powder coated in grey



Slim Chair stand
NS7501

Mobile stand with a metal frame for storing and transporting Slim chairs. Equipped with four wheels, including two with a brake. They can store a maximum of 10 chairs.

- dim.: 45 x 74 x 121 cm



PLASTIC SEAT AND BACKREST ON METAL FRAME

SHELLS

Size 6 ■
NS5062

Size 5 ■
NS5053



Size 4 ■
NS5041

Size 3 ■
NS5034

Size 2 ■
NS5025

Size 0 ■
NS5006



Size 1 ■
NS5007

Comfortable, colourful chair with profiled backrest and metal legs. Plastic seat with backrest form a whole. This form provides a dynamic support that relieves the spine and lumbar muscles, ensuring comfort despite several hours in a sitting position. Metal frame guarantees stability and durability while a handle facilitates moving the chair.

TYPE OF CHAIR

multielement (metal and plastic)
one size in one colour

AVAILABLE COLOURS



SEAT

- ergonomic profiled backrest
- holder for easy carrying
- stackable

LEGS

- nonadjustable height:
0 (21 cm), 1 (26 cm), 2 (31 cm), 3 (35 cm),
4 (38 cm), 5 (43 cm), 6 (46 cm),
- circle cross-section ø 29 mm
- self leveling foots
- metal

NORMS AND CERIFICATES

PN-EN 1729-1:2016-2
PN-EN 1729-2:+A1:2016-02



stackable



ergonomic profiled backrest



holder for
easy carrying



self leveling
foots



net protection
for transport

	NS5006	NS5007	NS5025	NS5034	NS5041	NS5053	NS5062
Size	0	1	2	3	4	5	6
Child height	80-95 cm	93-116 cm	108-121 cm	119-142 cm	133-159 cm	146-176,5 cm	159-188 cm
Seat height	21 cm	26 cm	31 cm	35 cm	38 cm	43 cm	46 cm
Top height	40 cm	46 cm	53 cm	59 cm	64 cm	71 cm	76 cm
Colour							

WOODEN

TEDDY

The body of the chair is made of light beech wood and the seat and back of moulded beech plywood. The chairs are varnished and stackable. Available in 5 sizes and certified for compliance.

- 1 pc;
- material: solid beech wood



Teddy 0
NS7860

- size 0 (21 cm);
- chair height 50 cm



Teddy 1
NS7861

- size 1 (26 cm);
- chair height 55,5 cm



Teddy 2
NS7862

- size 2 (31 cm);
- chair height 62 cm



Teddy 3
NS7863

- size 3 (35 cm);
- chair height 68 cm



Teddy 4
NS7864

- size 4 (38 cm);
- chair height 74 cm



TEDDY BEAR WOODEN PRESCHOOL CHAIR

with armrests

Size 0
NS7960

- seat height 21 cm

Size 1
NS7961

- seat height 26 cm

Size 2
NS7962

- seat height 31 cm



with armrests and harness

- red stylon harness, width: 3 cm;
- max. length: 47cm;
- black plastic buckle

Size 0
NS7970

- seat height 21 cm

Size 1
NS7971

- seat height 26 cm

Size 2
NS7972

- seat height 31 cm



TYPE OF CHAIR

one element (hardwood and plywood)
stackable

FRAME AVAILABLE IN COLOURS



beech

LEGS AVAILABLE IN COLOURS



beech

SEAT AND BACKREST

- plywood

LEGS

- nonadjustable
0 (21 cm), 1 (26 cm), 2 (31 cm), 3 (35 cm), 4 (38 cm)
- rectangular cross-section
- solid beech wood

ADDITIONAL ACCESSORIES

- safety harness
- armrests

NORMS AND CERTIFICATES

PN-EN 1729-1:2016
PN-EN 1729-2:+A1:2016

EMMI

Chairs made of birch plywood, fully varnished. Ergonomic seat and backrest with solid beech wood frame. All edges are rounded. Legs equipped with plastic glides. Regular chairs are stackable. Chairs with armrests are especially recommended for younger children. The special design of the armrests prevents the child from falling out. Regular chairs are available in 4 sizes: 0, 1, 2, 3 and chairs with armrest are available in 3 sizes: 0, 1, 2.

TYPE OF CHAIR

multielement (hardwood and plywood)

stackable

AVAILABLE SEAT COLOUR



birch

AVAILABLE LEGS COLOUR



birch

SEAT AND BACKREST

- plywood

LEGS

- nonadjustable height: 0 (21 cm), 1 (26 cm), 2 (31 cm), 3 (35 cm), 4 (38 cm)
- square cross-section
- beech hardwood

ADDITIONAL ACCESSORIES

- safety harness (sold separately)
- armrest

NORMS AND CERTIFICATES

PN-EN 1729-1:2 016-2

PN-EN 1729-2:+A1:2016-02



stackable

without armrest

Size	Code	Seat height
0	CH0004	21 cm
1	CH0001	26 cm
2	CH0002	31 cm
3	CH0003	35 cm



with armrest

Size	Code	Seat height
0	CH0008	21 cm
1	CH0005	26 cm
2	CH0006	31 cm



Pair of braces for Emmi with armrest CH0011

A set of chair straps suitable for all types of chairs. The straps are fastened with a plastic buckle at the front.

- material: synthetic fibre with metal elements;
- dominant colours: red

WITH CHILD PROTECTION



Emmi 0 CH0009

- seat height 21 cm

Emmi 1 CH0010

- seat height 26 cm



MIMI

Ergonomic and stackable chair with white back and contoured seat. The chair's frame resembles natural wood. It has rounded corners and edges. Legs are additionally equipped with plastic chair glides.

Size	Code	Seat height	Colour
0	NS9007	21 cm	Green
0	NS9040	21 cm	Grey
0	NS9050	21 cm	White
1	NS9041	26 cm	Grey
1	NS9014	26 cm	Blue
1	NS9004	26 cm	Orange
1	NS9051	26 cm	White
2	NS9042	31 cm	Grey
2	NS9005	31 cm	Yellow
2	NS9015	31 cm	Blue
2	NS9052	31 cm	White
3	NS9043	35 cm	Grey
3	NS9006	35 cm	Red
3	NS9053	35 cm	White

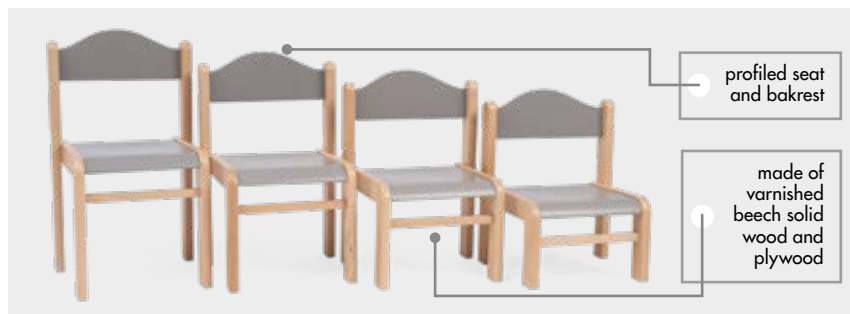



BUTTERFLY

TYPE OF CHAIR

one element (PVC)
stackable

AVAILABLE COLOURS



LEGS

- nonadjustable height:
0 (24 cm), 1 (26 cm),
2 (31 cm), 3 (35 cm),
4 (38 cm), 5 (43 cm), 6 (46 cm)

irregular cross-section



STACKABLE



you can put them on yourself,
saves space

the comfort of use
is ensured by a soft
and comfortable seat



**Butterfly chair 6 – grey with a soft seat
YC0650**

Profiled chair made of high-quality plastic. The comfort of use is ensured by a soft and comfortable seat.

- height of the seat: 46 cm, overall height: 80 cm;
- material: construction made of plastic and the seat of polyurethane foam covered with polyester fabric;
- colour: grey



Colour

! **Butterfly table
available on page 252**

- | | | | | | | |
|-----------------|-----------------|-------------------|-----------------|-----------------|-------------------|-------------------|
| • height 0 | • height 1 | • height 2 | • height 3 | • height 4 | • height 5 | • height 6 |
| • seat 24 cm | • seat 26 cm | • seat 31 cm | • seat 35 cm | • seat 38 cm | • seat 43 cm | • seat 46 cm |
| • overall 45 cm | • overall 51 cm | • overall 55,5 cm | • overall 64 cm | • overall 70 cm | • overall 77,5 cm | • overall 80,5 cm |

	YC0001	YC1001	YC2001	YC3001	YC4001	-	-
	YC0002	YC1002	YC2002	YC3002	YC4002	-	-
	YC0003	YC1003	YC2003	YC3003	YC4003	-	-
	YC0004	YC1004	YC2004	YC3004	YC4004	-	-
	YC0005	YC1005	YC2005	YC3005	YC4005	YC5005	YC6005

ORGANIZERS FOR CHAIRS

A practical and convenient textile organizer mountable on a chair back. The spacious pocket will hold textbooks, notebooks, folders and useful accessories. The organizer will help keep the place tidy thus providing a good working space for the child.

Chair organizer (green) NS1313

- dim.: 31 x 30;
- colour: green;
- material: cotton;
- fits Lilli chairs (size 0 and 1),
Teddy Bear chairs (size 0),
Karolek (size 2 and 3)



Chair organizer (blue) NS1222

- dim.: 22 x 30;
- colour: blue;
- material: cotton;
- fits Karolek chairs (size 0 and 1)

OFFICE CHAIRS

SHAPE SWIVEL CHAIR

A functional grey swivel chair made of high-quality material. Shiny metal frame on 5 casters. Height adjustable. Plastic seat with backrest in 1 part. The ergonomic shape ensures ideal support for the back.

- seat height 38 - 50 cm, seat width 42 cm, seat depth 47 cm, backrest height 42 cm; cross arm length 30 cm



Grey
YC9322

Blue
YC9323



UNI CHAIR

Swivel office chair ensuring comfort during many hours of work. Equipped with a soft, upholstered seat with ergonomic parameters. It has regulated, plastic armrests providing optimal height adjustment. The base of the seat is made of plastic and glass fiber. The set includes soft wheels that guarantee movement of the chair on both hard surfaces and carpets. Available in two colour versions.

Grey
DB3036

Black
DB3026



SWIVEL CHAIR

A swivel chair with a soft upholstered seat, an Oban fabric backrest and armrests made of polypropylene. The chair has got a black nylon base as well as self-locking fi 50 mm wheels designed for carpets or hard surfaces. It is also equipped with a CPT mechanism which allows users to adjust the seat depth with a screw, adjust the angle of the backrest in the range from +17 degrees to - 6 degrees and to block the angle of the backrest in a preferred position with a screw. Additionally, it is possible to smoothly adjust the chair's height thanks to the gas-lift cylinder.

- total height regulation: 97 – 115 cm;
- seat's height: 44,5 – 57,5 cm;
- seat's width: 46 cm;
- regulated seat's depth: 44,5 – 47 cm

Grey
SZ0072

Black
SZ0073



OFFICE CHAIR ISO

- H 82 cm;
- seat H 47 cm;
- W 54 cm;
- seat D 42 cm

 **Navy blue**
SZ0109

 **Black**
SZ0110

 **Grey**
SZ0113



STOOLS



**Mobile stool (blue)
YC0011**

A height-adjustable stool with 5 castors. The seat is made of plastic and no-slip rubber on a metal base. Ideal for school or professional labs;

- dim.: 47 x 47 cm;
- height adjustment 45 - 60 cm;
- 5 castors, colour: blue;
- materials: plastic, rubber, metal

STOOL ON METAL LEGS

The framework is made of powder painted white metal tubing D 25, T 1.5 mm. The seat is made of 18 mm HPL-finished laminated plywood.



The seat is made of 18 mm HPL finished laminated plywood

stackable

white metal tubing
D 25, T 1,5 mm



**Size 2
ATN200**

- seat 24,5 x 32,5 x 33,5 cm;
- material: metal, plywood;
- frame colour: white

**Size 3
ATN300**

- seat 25 x 36 cm x 37,9 cm;
- material: metal, plywood;
- frame colour: white

**Size 4
ATN400**

- seat 30 x 39 x 41,2 cm;
- material: metal, plywood;
- frame colour: white

**Size 5
ATN500**

- seat 30 x 43 x 45,3 cm;
- material: metal, plywood;
- frame colour: white

**Size 6
ATN600**

- seat 33 x 46,5 x 48,5 cm
- material: metal, plywood;
- frame colour: white

DESKS

FANTASY

- dim. desk: 120 x 52 x 76 cm;
- cabinet with lock (2 shelves inside);
- frame: colour birch, chipboard 18 mm;
- door: UV print or cutter, MDF board 12 mm

FRAME:

type of board: chipboard
plate thickness: 18mm
color: birch



birch

DOOR:

type of board: MDF
plate thickness: 12mm
color: white, mint



lock: yes



Gosling
NS2860



Woodpecker
NS2587



Unicorn
NS2880

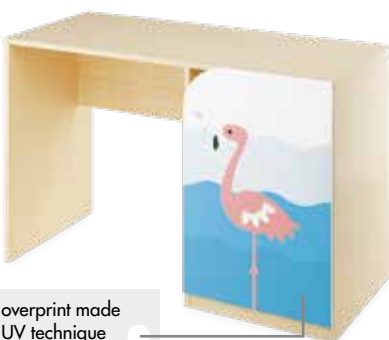

Flamingo
NS2820



Crab
NS2870



CUBO



Cubo desk
NC7001

A complementary item to the series. Its colour and construction will make it useful in any interior. Made of high-quality laminated board, there are places for drawers and doors, two practical drawers and a lockable slot with a shelf. The framework is made of birch laminate.

- dim.: 115 x 48 x 77,5 cm;
- drawers and doors sold separately

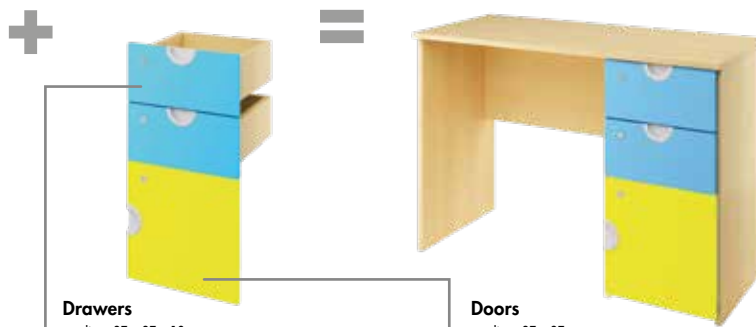

- Drawers**
- dim.: 37 x 37 x 18 cm;
 - 2 pcs; with lock

■	NC0012Z	Grey
□	NC0013Z	White
■	NC0014Z	Lime
■	NC0015Z	Blue
■	NC0016Z	Yellow
■	NC0017Z	Rose

- Doors**
- dim.: 37 x 37 cm;
 - with lock

■	NC0072Z	Grey
□	NC0073Z	White
■	NC0074Z	Lime
■	NC0075Z	Blue
■	NC0076Z	Yellow
■	NC0077Z	Rose



NC7001 +
NC0013Z + NC0077Z



NC7001 +
NC0016Z + NC0072Z



NC7001 +
NC0015Z + NC0074Z

INFO



Student's info desk

The desk has a keyboard drawer and a shelf for desktop computer. On the edge of the table top a hole for electric wires is located.

- dim.: 76 x 55 x 76 cm; material: laminated board

	NS2510	birch
	NS2530	beech

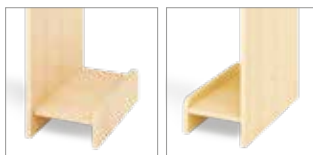

the shelf can be attached on the inner or outer side.



Small container on wheels with shelves

Mobile cabinet on wheels with three drawers closed with a central lock. Combined with a desk ensures more storage space for important documents.

- dim.: 34 x 45 x 60 cm, material: frame made of beech-coloured chipboard, 18 mm thick and white HDF board, 3,2 mm thick, the fronts of beech-coloured chipboard, 12 mm thick, side walls and the back of the drawer are made of beech-coloured chipboard, 18 mm thick while the bottom of drawers is made of HDF board, 3,2 mm thick, in white

	NS2532	beech
	NS2542	birch
	NS2512	birch + white doors
	NS2544	birch + grey doors

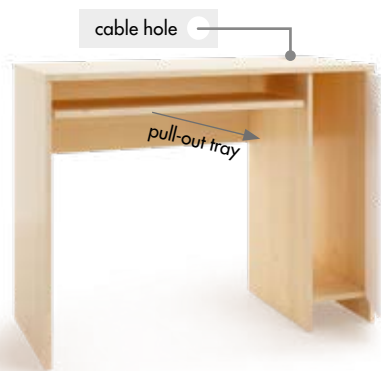

Large info desk for the computer

- dim.: 120 x 55 x 76 cm

	NS2531	beech
	NS2541	birch
	NS2511	birch + white doors
	NS2551	birch + grey doors



Desk with a comfortable sliding drawer for the keyboard and a computer cabinet. The cabinet has a back wall creating closed space. Inside, there is a shelf closed from the outside with a door and a lock. The hole in the top of the table top holds all electrical wires and prevents them from tangling.

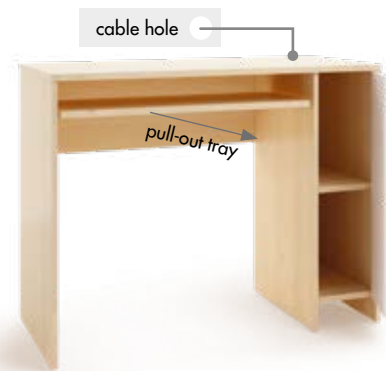

Large desk with a shelf

- dim.: 120 x 55 x 76 cm

	NS2533	beech
	NS2543	birch
	NS2513	birch + white doors
	NS2553	birch + grey doors



PROF

A teacher's desk made of laminated chipboard (beech or birch effect) with coloured fronts. Many colour configurations available. Will match most of our furniture series. Left or right hand option Installation possible for the cabinet and drawers. The locks restrict unauthorized

- access to documents;
- dim.: 120 x 60 x 77 cm

FRAME:

type of board: laminated chipboard
plate thickness: 18 mm
colour: birch/beech



DRAWERS:

type of board: MDF
plate thickness: 12 mm
colour front:



lock: yes

DOORS:

type: opened
type of board: MDF
plate thickness: 12 mm
surface: smooth
colour front:



lock: yes



COLOUR: BEECH

TEACHER'S DESK



Beech
NS2522



Beech - white
NS2500

TEACHER'S DESK WITH DOOR AND 1 DRAWER



Beech
NS2520



Beech - white
NS2501

TEACHER'S DESK WITH DOOR AND 2 DRAWERS



Beech
NS2521



Beech - white
NS2502

COLOUR: BIRCH

TEACHER'S DESK



White
NS2529



Birch - green
NS2506

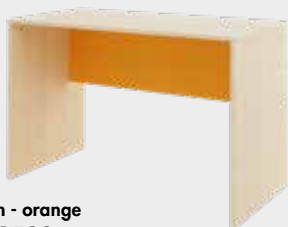

Birch - orange
NS2503



Birch
NS2523

TEACHER'S DESK
WITH DOOR AND 1 DRAWER

Birch - white
NS2519



Birch - green
NS2507



Birch - orange
NS2504



Birch
NS2524

TEACHER'S DESK
WITH DOOR AND 2 DRAWERS

Birch - white
NS2509



Birch - green
NS2508



Birch - orange
NS2505



Birch
NS2525

COMPUTER & LANGUAGE LAB



Teacher's desk
NS2562

- dim.: 134,5 x 54,5 x 76,5 cm;
- material: 18 mm birch chipboard frame, the back wall of the desk made of 18 mm chipboard in grey colour



Student's desk
NS2560

- dim.: 84,5 x 54,5 x 76,5 cm;
- material: 18 mm birch chipboard frame, 18 mm chipboard back wall of the desk, in grey colour



Add-on for the student's desk
NS2561

- dim.: 83 x 54,5 x 76,5 cm;
- material: 18 mm birch chipboard frame, the back of the add-on made of 18 mm chipboard in grey colour



Small corner shelves
NS2563

- dim.: 69,5 x 69,5 x 76,5 cm;
- material: 18 mm chipboard, birch coloured



Student's desk with tall sides
NS2570

- dim.: 84,5 x 54,5 x 136,5 cm, desktop H 76,5 cm, side wall H 60 cm;
- material: birch chipboard frame, 18 mm, the back wall of the desk made of chipboard, 18 mm, in grey



Add-on for the student's desk with tall sides
NS2571

- dim.: 83 x 54,5 x 136,5 cm, desktop H 76,5 cm, side wall H 60 cm;
- material: 18 mm birch chipboard frame, the back wall of the desk made of chipboard, 18 mm, in grey



Tall corner shelves
NS2573

- dim.: 69,5 x 69,5 x 136,5 cm, desktop H 76,5 cm, side wall H 60 cm;
- material: 18 mm chipboard frame, birch coloured

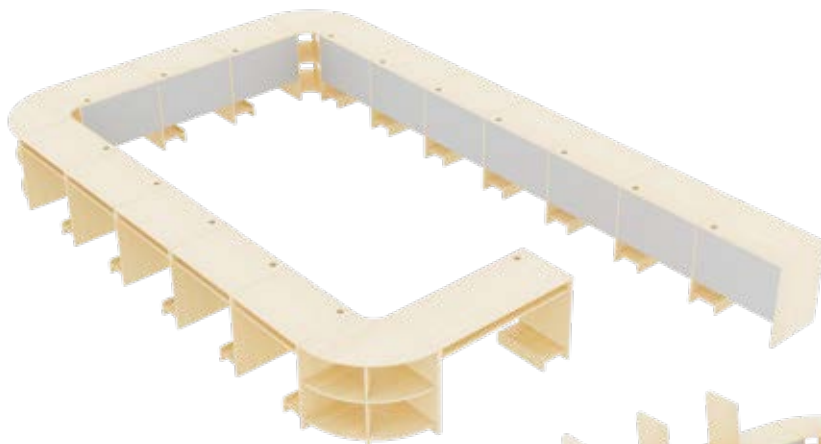

Computer lab - 15 stations. Set NS2565

The set contains:

- 1 x NS2562;
- 3 x NS2563;
- 15 x NS2561;
- set size: 650,8 x 389 cm

Computer lab – 15 stations with tall sides. Set NS2575

The set contains:

- 1 x NS2562;
- 3 x NS2573;
- 15 x NS2571;
- set size: 650,8 x 389 cm

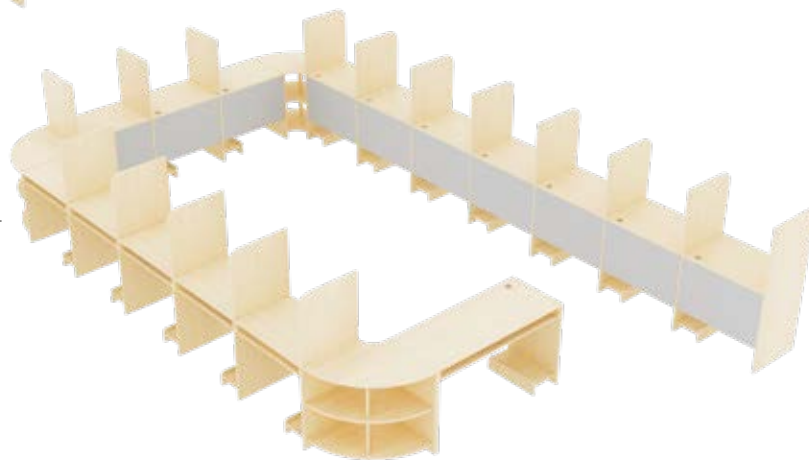

MANY POSSIBLE CONNECTIONS

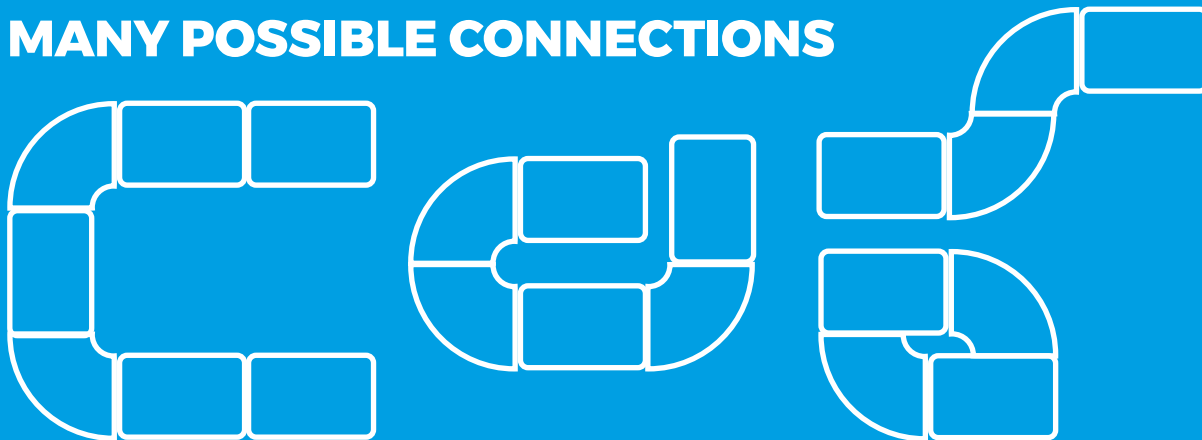





PRIMA



Desk right



- dim.: 155 x 110 x 75 cm

	birch	NB6201
	beech	NB6202



Desk left

- dim.: 155 x 110 x 75 cm

	birch	NB6101
	beech	NB6102

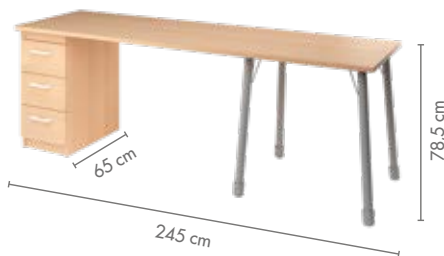



Desk with drawers

Big desk offering several options of assembly depending on the needs and room possibilities. It has 3 drawers closed with a central lock and an add-on which allows you to increase the work space.

- dim.: 160 x 65 x 78.5 cm;
- extension: 65 x 65 x 78.5 cm;
- drawer inside: 26 x 40 x 16 cm;
- material 18 and 25 mm particleboard;
- metal legs; requires assembly

	birch	NB6902
	beech	NB6901

	birch-white	NB6903
	beech-white	NB6904



EXCLUSIVE



RECEPTION DESKS



Birch
EXC9001

- dim.: 183,5 x 183,5 x 119 cm; 2 containers with 3 drawers, 4 dividers;
- material: frame made of chipboard, 25 mm thick, in birch colour, tabletop made of chipboard, 25 mm thick, in birch colour, dividers, drawer fronts and socles are made of chipboard, 18 mm thick, in birch colour



Birch and white
EXC9003

- dim.: 183,5 x 183,5 x 119 cm; 2 containers with 3 drawers, 4 dividers;
- material: frame made of chipboard, 25 mm thick, in birch and white colour, tabletop made of chipboard, 25 mm thick, in birch colour, dividers, drawer fronts and socles are made of chipboard, 18 mm thick, in white colour



HEADMASTER'S DESK WITH RAISED TABLE TOP AND DRAWERS



Birch
EXC5281

- dim.: 220 x 190,5 x 77 cm; 6 drawers, 4 open shelves;
- material: frame made of chipboard, 25 mm thick, in birch colour, drawer fronts made of chipboard, 18 mm thick, in birch colour, tabletop made of chipboard, 25 mm thick, in birch colour



Birch and white
EXC5283

- dim.: 220 x 190,5 x 77 cm; 6 drawers, 4 open shelves;
- material: frame made of chipboard, 25 mm thick, in birch colour, drawer fronts made of chipboard, 18 mm thick, in white colour, tabletop made of chipboard, 25 mm thick, in birch colour

HEADMASTER'S DESK WITH DRAWERS



Birch
EXC5291

- dim.: 220 x 168 x 77 cm; 8 drawers, 4 open shelves;
- material: frame made of chipboard, 25 mm thick, in birch colour, drawer fronts made of chipboard, 18 mm thick, in birch colour, tabletop made of chipboard, 25 mm thick, in birch colour



Birch and white
EXC5293

- dim.: 220 x 168 x 77 cm; 8 drawers, 4 open shelves;
- material: frame made of chipboard, 25 mm thick, in birch colour, drawer fronts made of chipboard, 18 mm thick, in white colour, tabletop made of chipboard, 25 mm thick, in birch colour



KASIA

A functional, aesthetically pleasing, work-friendly desk for a classroom or teacher's room. The natural light beech and the front veneers in the colours of the tables and chairs create a unique teamwork atmosphere.

- dim.: 120 x 75 x 76 cm

FRAME:

type of board: chipboard

plate thickness: 18 mm

colour:



beech

DRAWERS:

type of board: MDF

plate thickness: 18 mm

colour:



	NS0798CZ	Red
	NS0798ZI	Green
	NS0798NI	Blue
	NS0798ZL	Yellow
	NS0798P	Orange



ALA

FRAME:

type of board: chipboard
plate thickness: 18 mm
colour: beech

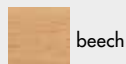

beech

DRAWERS:

type of board: MDF
plate thickness: 18 mm
colour:

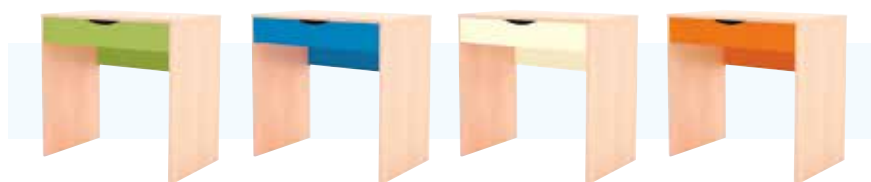

A light comfortable stable desk pleasing to the eye.
It has a large drawer.

- dim.: 80 x 47,5 x 76 cm

NS1500K	Creme
NS1500ZL	Yellow
NS1500P	Orange
NS1500JZI	Light green
NS1500NI	Blue



TRAIN

FRAME:

type of board: chipboard
plate thickness: 18 mm
colour:



DRAWERS:

type of board: chipboard
plate thickness: 18 mm
colour:



small drawer
dim.: 32 x 42 x 16 cm

large drawer
dim.: 32 x 42 x 29 cm

Train White desk
NS0257

- dim.: 120 x 75 x 76 cm

CLOAKROOMS

CUBO



doors available in 6 colours



Cubo Cloakroom 6 NC8161

- dim.: 138 x 35 x 131 cm;
- 6 compartments, 6 yellow star-shaped triple hooks;
- shoe rack;
- laminated particle board (birch), metal, plastic



3 yellow star-shaped



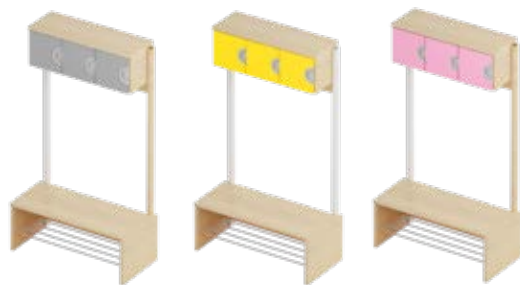

Cubo Cloakroom 3 NC8131

- dim.: 75 x 35 x 131 cm;
- 3 compartments, 3 yellow star-shaped triple hooks;
- shoe rack;
- laminated particle board (birch)



3 yellow star-shaped

Doors for cubo cloakroom unit

- 3 pcs (dim.: 21 x 21 cm);
- handle, laminated 18 mm particle board



Grey
NC8232



Blue
NC8235



White
NC8233



Lemon grass
NC8234



Yellow
NC8236



Pink
NC8237



CRAYON





This series combines functionality and economy of space. Open shelves are a great solution for a small cramped room where easy access to things saves time and makes changing clothes and shoes easy. The triple coat hook will easily hold coats and shoe bags and the rack under the bench will help keep shoes under control.

Available in colours:



CLOAKROOM 3





- dim.: 75 x 35 x 132 cm

	NS5100	yellow
	NS5101	lite blue
	NS5102	blue
	NS5103	green
	NS5104	red



CLOAKROOM 6





- dim.: 138 x 35 x 132 cm

	NS5200	yellow
	NS5201	lite blue
	NS5202	blue
	NS5203	green
	NS5204	red



CORNER CLOAKROOM 4

- dim.: 64 x 66 x 132 cm

	NS5300	yellow
	NS5301	lite blue
	NS5302	blue
	NS5303	green
	NS5304	red

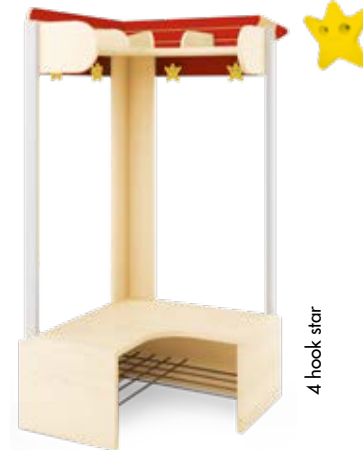



3 hook star



SHELF 3

• dim.: 72 x 26 x 21 cm

■ NS5110	yellow
■ NS5111	light blue
■ NS5112	blue
■ NS5113	green
■ NS5114	red

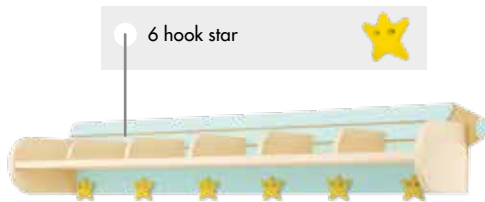

6 hook star



SHELF 6

• dim.: 134 x 26 x 21 cm

■ NS5210	yellow
■ NS5211	light blue
■ NS5212	blue
■ NS5213	green
■ NS5214	red



4 hook star



CORNER SHELF 4

• dim.: 60 x 64 x 21 cm

■ NS5310	yellow
■ NS5311	light blue
■ NS5312	blue
■ NS5313	green
■ NS5314	red



Bench 3
NS5125

• dim.: 73 x 35 x 29 cm



Bench 6
NS5225

• dim.: 136 x 35 x 29 cm



Corner Bench 4
NS5325

• dim.: 64 x 64 x 29 cm

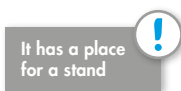

It has a place for a stand

SOFT SEATS

Comfortable and practical seats with colourful prints of the crayons. They complement perfectly changing room or corridor spaces. They can be also used during gymnastic exercises or rehabilitation. Made of durable polyurethane foam with increased density, ensuring comfort while sitting. Phthalate-free PVC fabric is easy to clean and disinfect. The non-slip bottom ensures safety and stability during activities.

- material: polyurethane foam, PVC fabric in grey, with crayons print;
- non-slip bottom



non-slip bottom



Crayons seat - cube
NS3162

• dim.: 38 x 38 x 32 cm



Crayons seat - semicircular
NS3161

• dim.: 49 x 38 x 32 cm



Crayons seat - round
NS3163

• dim.: 38 x 38 x 32 cm



CROCODILE

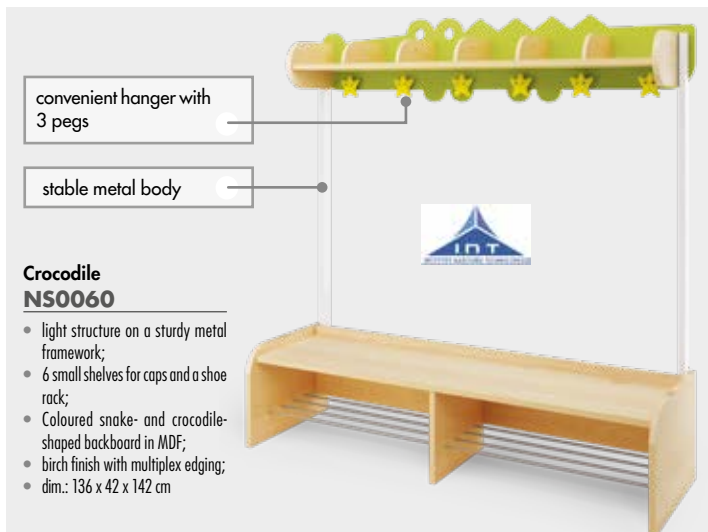

SHOES HANGERS

Cactus for shoes NS1720

- a rack for 12 pairs of rubber boots;
- a 80 cm H 160 cm



BUTTERFLY



Shelf NS0583A

- dim.: 120 x 21 x 28 cm

wall-mounted

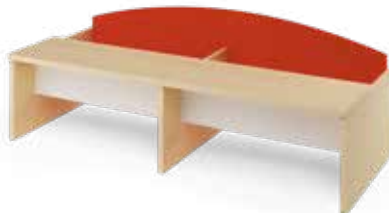

Bench NS0584A

- dim.: 120 x 50 x 30 cm

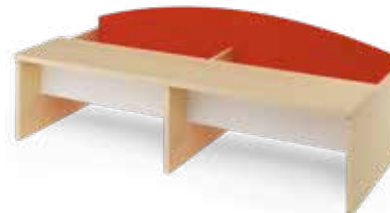

Bench + shelf NS1584

- NS0584A + NS0583A

ARABESKA

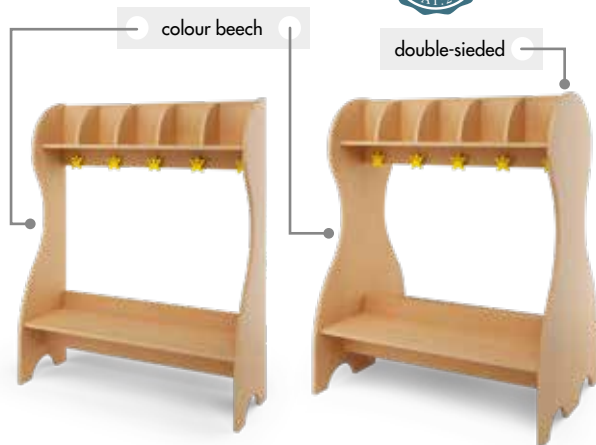

Arabeska – one-sided
NS0582

- for 5 children, dim.: 105 x 36 x 131 cm

Arabeska – double-sided
NS0582A

- for 10 children, dim.: 105 x 75 x 131 cm



HARMONIA

This light beech cloakroom has practical hooks, an openwork compartment for shoes which helps keep the floor free from rainwater and dirt, the additional back panel can hold an identification for each child.



Harmonia 3
NS0752

- dim.: 78 x 50 x 140,5 cm;
- bench H 26 cm

Harmonia 6
NS0751

- dim.: 154 x 50 x 140,5 cm;
- bench H 26 cm



Vita



Thanks to their different widths of its modules, the cloakroom Vita can be adapted to every room. With little space available, it is worthwhile organizing every square inch. The new corner version of Vita cleverly combines simple modules to use corner space effectively.

- doors in 6 colours; sold separately



W 69 cm
D 44 cm
H 131 cm



W 69 cm
D 69 cm
H 131 cm

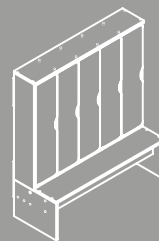

W 113 cm
D 44 cm
H 131 cm

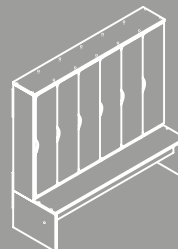

W 135 cm
D 44 cm
H 131 cm





Vita 3
NS2943

- dim.: 69 x 44 x 131 cm



Vita corner 4
NS2944

- dim.: 69 x 68 x 131 cm



Vita 5
NS2945

- dim.: 113 x 44 x 131 cm



Vita 6
NS2946

- dim.: 135 x 44 x 131 cm



DOOR

Doors for the functional Vita cloakroom were made of MDF board with multiplex rim. Available in various colours.



- 3 pcs; for NS2943



- 4 pcs; for NS2944



- 5 pcs; for NS2945



- 6 pcs; for NS2946

■	NS1876	green
■	NS1878	orange
■	NS1877	blue
■	NS1735	yellow
□	NS2950	white
■	NS2954	grey

■	NS2912	green
■	NS2914	orange
■	NS2913	blue
■	NS2911	yellow
□	NS2951	white
■	NS2955	gray

■	NS1731	green
■	NS1733	orange
■	NS1732	blue
■	NS1734	yellow
□	NS2952	white
■	NS2956	grey

■	NS1880	green
■	NS1882	orange
■	NS1881	blue
■	NS1736	yellow
□	NS2953	white
■	NS2957	grey

RAINBOW & PASTEL



NP5000 or NP5100 + NP5017



Rainbow cloakroom unit with hooks
NP5000

- dim.: 130 x 35 x 172;
- 8 cabinets, each with a star-shaped hook and a shelf;
- materials: laminated chipboard 18 mm

Body for the Rainbow cloakroom. Each compartment has a hook and one or two shelves. The two-level modules provide extra storage space for clothes.

- doors (sold separately) are available in 8 colours version with bear-shaped carvings and cut-outs serving as handles;
- 8 compartments



Rainbow cloakroom unit with shelves
NP5100

- dim.: 130 x 35 x 172;
- 8 cabinets, each with 2 shelves;
- materials: laminated chipboard 18 mm

DOORS FOR CLOAKROOMS

- 8 pcs; 8 pcs with bear-shaped carvings and a handle; dim. 30 x 76 cm; material: MDF board 12 mm;



READY FURNITURE

NP5000 or NP5100 + NP5018

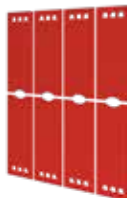

Red
NP5011



Green
NP5013



Yellow
NP5014



Mix Rainbow
NP5017

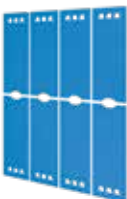

Blue
NP5012

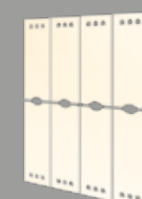

Creme
NP5015

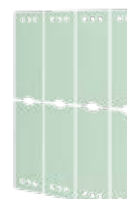

Mint
NP5016



Mix Pastel
NP5018

FALME-RETARDANT

Made of fire-retardant laminated 18 mm chipboard with double-sided decorative melamine coating. PFC and PEFC certified. It meets fire safety requirements for public institutions. It has

3 compartments, 3 double hooks, comfortable seat for changing shoes and a metal shoe rack underneath.

- materials: laminated 18 mm chipboard, metal



Cloakroom unit (blue)
NS5205

- dim.: 75 x 35 x 132 cm; colour: birch, blue



Cloakroom unit (yellow)
NS5105

- dim.: 75 x 35 x 132 cm; colour: birch, yellow

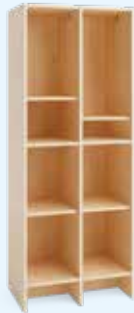

Locker
NS1470

- dim.: 66 x 40 x 182,5 cm;
- height-adjustable shelves;
- colour: birch



Locker extension
NS1471

- dim.: 32,2 x 40 x 182,5 cm;
- height-adjustable shelves;
- colour: birch

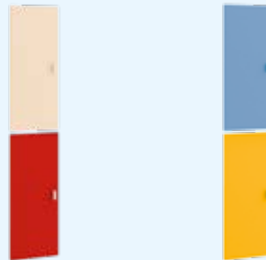

Locker doors

A pair of doors for the flame-retardant locker.

- 2 pcs; dim.: 30 x 82 cm;
- material: laminated chipboard 18 mm thick;

NS1472

- colour: red, cream

NS1473

- colour: blue, yellow



EXAMPLES OF ARRANGEMENTS



METAL

Metal wardrobes and add-ons, which when combined, create a functional cloakroom. The colourful doors make the space more welcoming for children and teenagers. The solid construction of the wardrobes and the material from which they were made, guarantee their durability.

FRAME

material: metal
thickness: 0,7 mm
colour: light grey



DOOR

material: metal
sheet thickness: 0,7 mm
colour:



handle: plastic
lock: yes

LOW 4-PERSON METAL CLOAKROOM



- dim.: 152 x 48 x 135 cm,
- dim. of the container: 37 x 40 x 128 cm,
- dim. of the doors: 38 x 129 cm
- the body of the wardrobe is grey, doors are grey, blue, yellow and green

NG4224 yellow

NG4214 blue

NG4234 green

NG4204 grey

ADD-ON FOR LOW 4-PERSON METAL CLOAKROOM



- dim.: 380 x 48 x 135 cm;
- dim. of the container: 37 x 40 x 128 cm;
- dim. of the doors: 37,8 x 129,3 cm;
- the body of the wardrobe is grey, doors are yellow

NG4221 yellow

NG4211 blue

NG4231 green

NG4201 grey

EXAMPLES OF ARRANGEMENTS

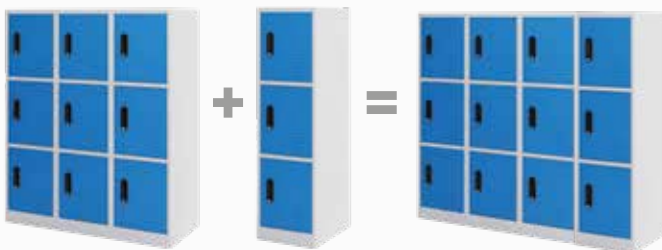

TALL 4-PERSON METAL CLOAKROOM WITH DOORS

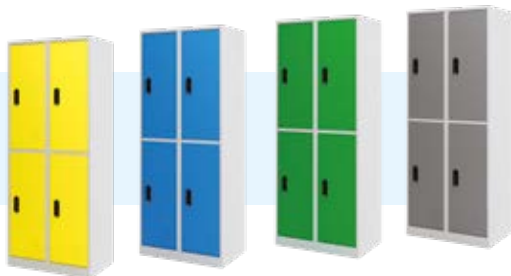

- dim. of the frame: 76 x 48 x 185 cm;
- 4 containers, dim.: 38 x 44 x 86 cm;
- 4 doors, dim.: 33 x 85; grey frame,
- doors in grey, blue, yellow and green colour; 2 keys; material: metal

■	NG4424	yellow
■	NG4414	blue
■	NG4434	green
■	NG4404	grey

TALL 8-PERSON METAL CLOAKROOM



- dim.: 76 x 48 x 175 cm,
- dim. of the container: 33 x 45 x 38,1 cm,
- dim. of the doors: 32,7 x 37,8 cm
- the body of the wardrobe is grey, doors are grey, blue, yellow and green

■	NG8828	yellow
■	NG8818	blue
■	NG8838	green
■	NG8808	grey

9-PERSON METAL CLOAKROOM



- dim.: 114 x 48 x 135 cm;
- dim. of the container: 37,5 x 44 x 40 cm;
- dim. of the doors: 32,7 x 37,8 cm;
- the body of the wardrobe is grey, doors are grey, yellow, blue and green

■	NG9929	yellow
■	NG9919	blue
■	NG9939	green
■	NG9909	grey

3-PERSON ADD-ON FOR 9-PERSON METAL CLOAKROOM

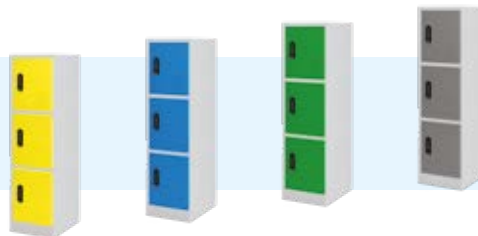

- dim.: 38 x 48 x 135 cm;
- dim. of the container: 38 x 45 x 38 cm;
- dim. of the doors: 32,7 x 37,8 cm;
- the body of the wardrobe is grey, doors are grey, yellow, blue and green

■	NG9323	yellow
■	NG9313	blue
■	NG9333	green
■	NG9303	grey



Lock with keys for metal cloakrooms
NG6010K

- 2 keys



a key for the head person
to open all lockers

Master key for lockers
NG6010W

HANGERS

Metal hook rail AUN050

- length 48,5 cm; 5 double hooks 2 x 4 x 0,15 cm;
- weight 0,89 kg; material: metal; colour: grey



Metal hook rail AUN100

- length 1,0 cm; 10 double hooks 2 x 4 x 0,15 cm;
- weight 1,76 kg; material: metal; colour: grey

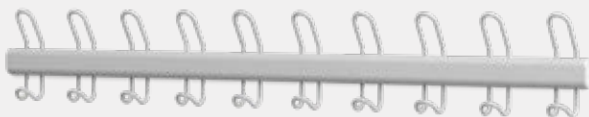

Metal hanger OK0055

- set of 5 pcs



Coat hook rail with metal hooks NS2925

- dim.: 124 x 4 x 12 cm; 10 double metal hooks

Star hanger OK7005

A plastic hanger in the shape of a five-pointed star.

- set of 5 pieces;
- delivered with screws



Board with hangers NS2905

- blue MDF board + yellow plastic double hooks;
- dim.: 124 x 12 x 4 cm;
- 10 double hooks

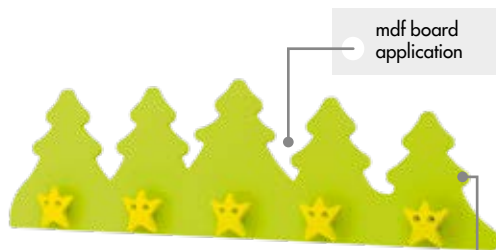

Wood. Hook rail NS1727

- cloakroom accessory with 5 double hooks;
- dim.: 92 x 1,2 cm x 27 cm

each hook has three arms



STORAGE

MAINTENANCE STORAGE



Storage unit for utility room NG9020

Functional utility cabinet with double doors equipped with a key lock. Divided into two parts. On the left there are four shelves for storing cleaning products, on the right there is space for cleaning equipment. The lack of a partition wall in the lower part allows you to keep, for example, buckets or shoes. The back wall has been perforated. The cabinet is made of metal and the powder coating protects it against mechanical damage as well as corrosion.

- dim.: 76 x 60 x 185 cm;
- material: metal;
- colour: light and dark grey;
- set of 2 keys included



Solid metal unit, which will prove useful especially in workshops or studios, for storing heavy items. The simple construction helps to maximise the usable space of the furniture.



BACKPACK STORAGE

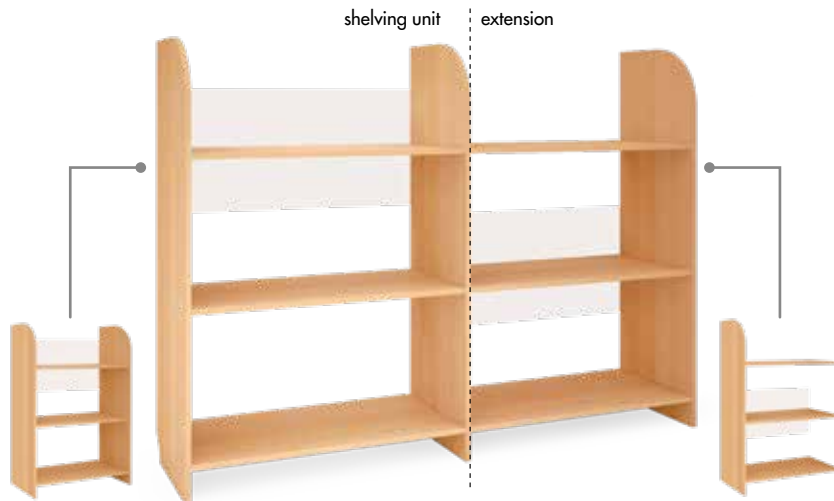

**Upright Backpack Storage Unit
NS2125**

A unit with 3 shelves (colour: beech) to hold about 9 backpacks. Extra space available with an extension. The top corners are rounded and the unit can be fixed to the wall, which makes it comfortable and easy to use.

- W 93,6 cm; D 40 cm; H 135,6 cm

**Upright Backpack. Storage Unit Extension
NS2126**

An extension to the backpack storage unit in beech colour. Consists of a side wall and 3 shelves. Easy and safe to use thanks to the rounded top corners and the possibility of wall fixing

- W 93,6; D 40 cm; H 135,6 cm



**Backpack Storage Unit
NS2127**

A unit with 12 shelves for storing down standard backpacks. Made of a laminated board in birch colour. Comfortable and easy to use thanks to its rounded corners and wall attachability.

- W 127 cm, D 43,5 cm, H with the protective board 152 cm, w/o 118 cm

MOBILE STORAGE

A practical box with a lid and on castors for easy storage of sports equipment indoors. Padlockable.

- dim.: 138 x 63 x 70 cm



**Chest for sports equipment
NS2906**

- MDF chipboard in grey and orange



**Chest for sports accessories
ML2906**

- MDF chipboard in marmara blue and grey

BENCHES

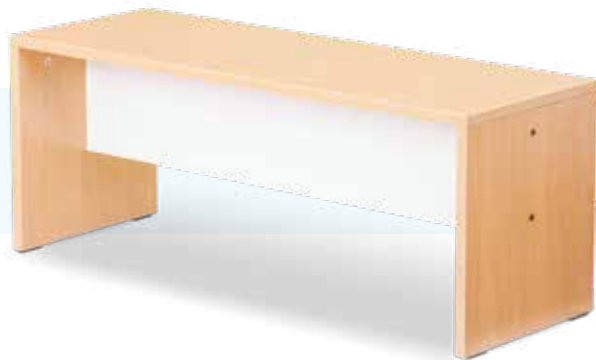

Harmonia bench
NS1725

- dim.: 92 x 33 x 36 cm





Bench

- steel frame and legs;
- seat thickness 25 mm;
- dim.: 120 x 36 x 34 cm



available seat colour:

	NS0325	beech
	NS0325/1	yellow
	NS0325/2	blue
	NS0325/3	green
	NS0325/4	red

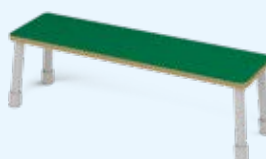

TALL FOAM FOLDING SEAT

- dim.: 120 x 45 x 45 cm; material: high-density polyurethane foam, phthalates-free PVC fabric non-slip PVC fabric available in 4 colours; handles



White
NS3170

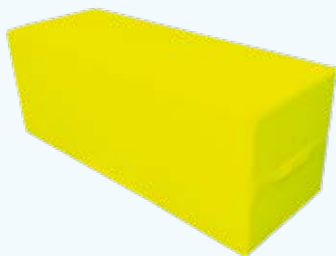

Lime
NS2286



Blue
NS2285



Grey
NS2284

This practical seat is a comfortable solution for sitting or laying down in spaces intended for relaxation and calming emotions. The construction made of high-density polyurethane foam ensures the stability of the seat. PVC fabric without phthalates and non-slip bottom guarantee safety while in use. Specially designed handles allow the seat to be easily relocated.



chipboard frame

Cloakroom seat
NS1718

- A stable seat made of chipboard with foam padding.
- dim.: 100 x 40 x 43 cm



ACCESORIES



**Drawstring bag
NS0118**

A comfortable bag for shoes or gym kit.

- 1 pcs;
- made of denim;
- dim.: 44 x 29 cm



**Self-adhesive ID photo frames
NS0353**

- 5 pcs;
- size: 7 x 8 cm

**Self-adhesive name tags
NS3049**

- 30 pcs;
- size: 6 x 2 cm with a slot for child's name



ID STICKERS



**Peg labels - Toys
NS2980**

- 25 pcs, ø 5 cm, self-adhesive



**Set A
NS0935**

- 25 pcs; 4,7 x 5,6 cm



**Set B
NS0936**

- 25 pcs; 4,7 x 5,6 cm



**Set C
NS0933**

- 25 pcs; 4,7 x 5,6 cm



**Peg labels - Wood
NS2981**

- 25 pcs, ø 5 cm, self-adhesive



**Set D
NS0934**

- 25 pcs; 4,7 x 5,6 cm



**Set E
NS3028**

- 35 pcs; 5 x 5,5 cm



**Set F
NS3027**

- 35 pcs; 5 x 5,5 cm

BEDROOM

KIDDY COTS

Available in colour:



Made of steel tubing and stable colourful plastic elements. The corner parts serving as legs are rounded and have bolts inside inaccessible to children. The fabric is made of non-flammable and non-toxic material. Thanks to its mesh structure it is airy, easy to clean, and its tension can be easily adjusted even after long use. For easy transportation, the beds should be stacked on a dedicated trolley (NS0758).

Kiddy Cot

- dim.: 133 x 57 x 15 cm;
- available in colours:

	NS0754NI	blue
	NS0754PO	orange
	NS0754ZI	yellow
	NS0754ZL	green
	NS0754SZ	grey

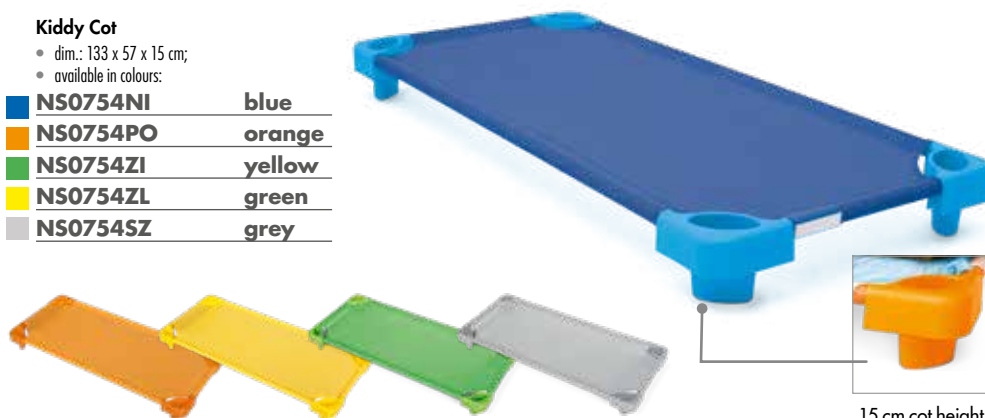

15 cm cot height



SET

Kiddy Cots set

- dim.: 133 x 57 x 15 cm;
- available in colours:

■	NS0754NI/6	blue
■	NS0754PO/6	orange
■	NS0754ZI/6	yellow
■	NS0754ZL/6	green
■	NS0754SZ/6	grey



Guard rail for kiddy cot

A plastic barrier to prevent the child from falling off the bed. The light construction and simple easy assembly guarantee safety. You only need to slide the rails onto the corner plastic fixings.

- available in colours:

■	NS0763NI	blue
■	NS0763PO	orange
■	NS0763ZI	green
■	NS0763ZL	yellow
■	NS0763SZ	grey



Cot legs

- they raise the cot by 11 cm;
- 4 pcs;
- available in colours:

■	NS0757NI	blue
■	NS0757PO	orange
■	NS0757ZI	yellow
■	NS0757ZL	green
■	NS0757SZ	grey



Mattress for Kiddy Cots NS2160

Designed to fit a Kiddy Cot[®] bed. Removable zippered cotton cover. Foam mat inside

- dim.: 123 x 50 cm; thickness 5 cm



Trolley for beds NS0758

- suitable for kiddy cots;
- maximum for 15 cots;
- dim.: 133 x 58 x 12 cm



Cot name clip NS0761

Made of synthetic fabric. To be placed on top of the cot. Use: accessories for kiddy cots.

- 1 pc



Cover for kiddy cots NS1825

Great to store kiddy cots. With the zips on the corners and the velcros, it can be easily adjusted to the quantity of beds. Made of durable polyester fabric Oxford, easy to clean.

**A COVER FOR THE WHOLE GROUP
CAN ACCOMMODATE 20 COTS**



White wooden kiddy crib GP4006

Kiddy crib with regulated height. Special covers on the sides of the cotbed protect it against bitemarks and stains. The covers can be easily removed for cleaning. The rungs are not removable.

- dim.: 100 x 50 cm;
- dim. on the outside: 104 x 55 x 90,5 cm;
- weight: 9,5 kg;
- colour: white;
- material: varnished pine wood;
- age: 0-2 years

Mattress for white wooden kiddy crib NS0652

Mattress suitable for white wooden kiddy crib. Made of poliurethane foam with cotton cover with zipper in white colour. Can be washed in 40 degree C.

- dim.: 100 x 50 x 10 cm

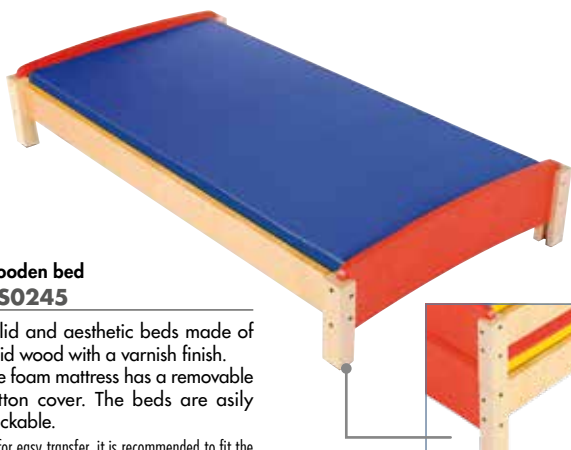

Wooden bed NS0245

Solid and aesthetic beds made of solid wood with a varnish finish. The foam mattress has a removable cotton cover. The beds areasily stackable.

- for easy transfer, it is recommended to fit the first bed with castors NS0255;
- dim.: 128 x 67 x 21 cm

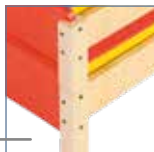

the beds are easily stackable



Pinewood kiddy crib GP4001

Made of solid pinewood; slat mattress base

- dim.: 60 x 120 x 76 cm;
- 3 adjustable heights;
- mattress sold separately



Mattress pinewood kiddy crib NS0651

Made of poliurethane foam with cotton cover with zipper in yellow colour.

- cover can be washed in 40 degree C;
- fits beds GP4001;
- dim.: 60 x 120 cm

Foldable automatic baby swing FB0001

- safety strap plastic swing baby rocker;
- frame: steel tube with coating;
- 1 toy bar with 3 toys;
- 3 point safety clasp;
- covering: 150D Polyester Fabric and TC unfolded size: 70 x 40 x 51 cm



Rocking chair with music TU0038

A stable interactive rocking chair convertible into a stationary seat. Button-activated calming vibrations help soothe the baby. The toy arch with 3 toys including a music box. On releasing a lock the rocker turns into a stable bed. The baby stays safe inside thanks to a lap belt. When the right time comes, the rocker can be converted into a comfortable chair.

- maximum load 27 kg;
- dim.: ca 70 x 43 x 55 cm;
- requires 1 LR20 battery;
- age: 0+



Foldable bed FB0004

- dim.: 120 x 60 x 72,5 cm,
- melange fabric, steel tube, with zipper entrance

BED LINEN

Cotton bed linen in pastel colours perfect for Kiddy cots and baby cribs. The set includes: a quilt, a pillow, bed linen and a white bedsheet.

- 1 x quilt: 110 x 94 cm; 1 x pillow: 38 x 27 cm;
- 1 x quilt cover: 114 x 98 cm; 1 x pillowcase: 38 x 27 cm;
- 1 x bed sheet: 140 x 68 cm

MINTY



Bed linen – green Minty
NS3648

Covers for bedding
NS3649



Bed linen – grey Minty
NS3650

Covers for bedding
NS3651

ROYAL

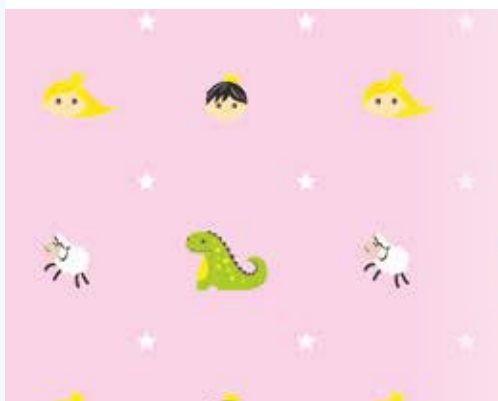

Bed linen – blue Royal
NS2645

Blue Royal covers for bedding
NS2647



Bed linen – pink Royal
NS2644

Pink Royal covers for bedding
NS2646

MONOCOLOUR



Bed linen – Blue
NS1645

Blue covers for bedding
NS1647



Bed linen – Pnk
NS1644

Pink covers for bedding
NS1646

ACCESORIES



Blanket
NS0648

Light and pleasant to the touch blanket finished with a hem.

- 1 pc; dim.: 147 x 97 cm;
- grey colour; material: fleece



Large fleece blanket – grey
NS2088

Ultra light and warm fleece blanket

- dim.: 140 x 220 cm

A soft and light pillow made of cotton. The size fits all pillowcases in our offer. It complements Sleeping Beds.



Pillow
NS1650

- dim.: 38 x 27 cm;
- not recommended to wash the pillow

- 1 pc;
- material: 100% cotton in white colour



Quilt
NS1648

- dim.: 110 x 94 cm;
- dry clean only

Bedsheet

The sheet is fastened with elastics in the four corners of the cot. It complements Sleepy cots.



- yellow
NS1651

- 1 pc; dim.: 67 x 137 cm;
- yellow colour;
- material: 20% polyester, 80% cotton;
- can be washed at 60 degrees C



- white
NS1649



Waterproof underlay
NS2648

It is made of soft to touch and waterproof foil. It has stitched rims, which ensures comfort and protects against delamination of the undercoat.

- dim.: 64 x 90 cm, weight 120g, material: 50% cotton, 50% polyester, membrane: 100% polyurethane, white color, washing temperature 30 °C



Sleeping bag
NS0760

A comfortable soft-touch turquoise patterned sleeping bag for children. Made of high-quality cotton, Polartec lined, zippable and with an integrated pillow.

- width when unzipped 140 cm;
- length 145 cm w/pillow, 110 cm w/o pillow
- 70% polyester, 30% cotton



Black & White Mat
NS2104

Made of soft touch material – drill with foam filling

- dim.: 100 x 100 cm, washable

BEDDINGS FOR ADULTS



Pillowcases and quilt covers. Grey with a print NS2084

Cotton pillowcases and quilt covers with subtle triangles print. Fastened with a comfortable zipper.

- dim. pillowcase: 70 x 80 cm, quilt cover: 120 x 200 cm



Light quilted pillow NS2086

Polycotton quilted pillow 750-800g.

- dim.: 70 x 80 cm



Large bed sheet - white NS2085

White cotton bedsheet.

- dim.: 140 x 200 cm



Large light quilt NS2087

Ultra light and warm quilt made of polycotton 200-250 g.

- dim.: 120 x 200 cm

BEDDING STORAGE CABINET



Doors sold separately 

Bedding cabinet topper NS1822

- 9 shelves;
- dim.: 67,5 x 38 x 98 cm



Cabinet for bedding NS1821

- 15 shelves;
- 123 x 38 x 98 cm;
- shelves 31 x 21 x 36,5 cm



9 shelves
31 x 36,5 x 21 cm



15 shelves
31 x 36,5 x 21 cm



SPACE FOR 24 BEDDING SETS

DOORS



For Cabinet

- dim.: 48,5 x 111 cm;
- sold in pairs

Creamy
NS2833

Light Blue
NS2834

For Add-on

- dim.: 48,5 x 66 cm;
- sold in pairs

Creamy
NS2843

Light Blue
NS2844



COTS AND BEDDING STORAGE

CABINET



**Bed Cabinet
NS2845**

- dim.: 141 x 61 x 120 cm



**Bed and Bedding
Cabinet
NS2846**

- dim.: 141 x 61 x 200 cm

DOORS

- made of chipboard, 18 mm thick;
- surface: smooth; the handle is made of grey plastic



Doors Cubo for bedding cabinet

- dim.: 70 x 108 cm;
- sold in pairs

■ **NC5102 grey**

□ **NC5103 white**

■ **NC5104 lime**

■ **NC5105 marine**

■ **NC5106 yellow**

■ **NC5107 rose**

Doors Cubo for bedding cabinet

- dim.: 70 x 80 cm;
- sold in pairs

■ **NC5002 grey**

□ **NC5003 white**

■ **NC5004 lime**

■ **NC5005 marine**

■ **NC5006 yellow**

■ **NC5007 rose**

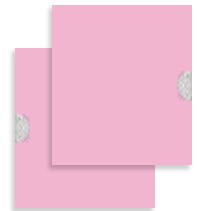

Doors for bed cabinet

- dim.: 70 x 108 cm;
- sold in pairs

■ **NS2853 crema**

■ **NS2854 mint**

Doors for bed cabinet

- dim.: 70 x 80 cm;
- sold in pairs

■ **NS2863 crema**

■ **NS2864 mint**

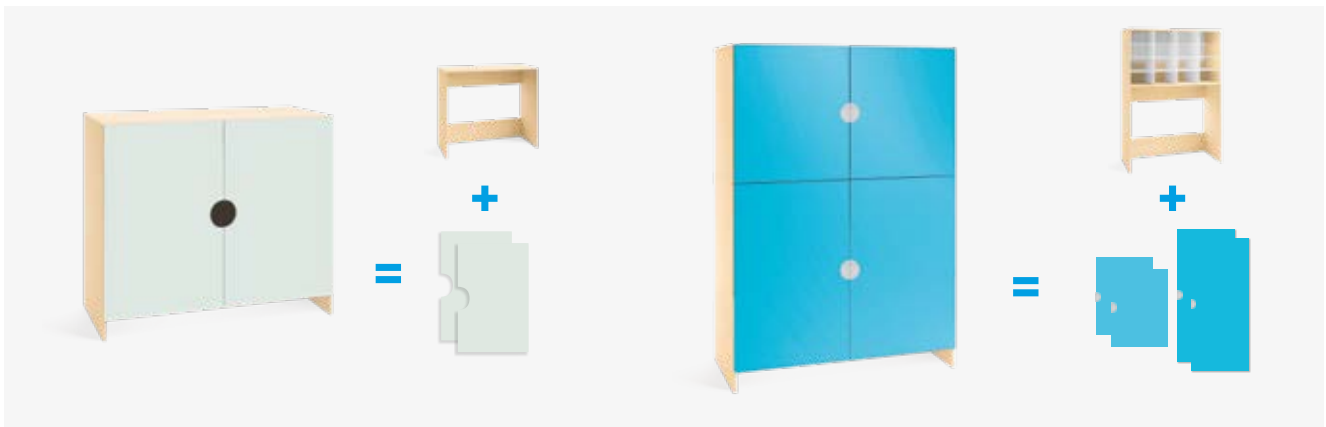



CURTAINS



**Curains for Bed cabinet
NS2847**

- 2 pcs; dim.: 70 x 115 cm;
- blue; hang on straps; bar in set

MINTY CABINET



shelves for 16 bedding sets
locker dim.: 34 x 50 x 19 cm



space for 16 cots

**Storage for beds and linen
NS3208**

- dim.: 141 x 60 x 200 cm
- space for 16 bedding sets and 16 cots



BATHROOM

POT STORAGE

TALL CABINET

Extension for chamber pot storage unit NS3226

- dim.: 98 x 39 x 47 cm; 6 compartments;
- compartment dim.: 30 x 37 x 22 cm;
- a pair of milled doors; material; laminated chipboard in birch effect;
- fronts: MDF, green

for 6 pots



for 15 pots



Chamber pot storage unit NS3225

- dim.: 98 x 39 x 130 cm; 15 compartments;
- compartment dim.: 30 x 37 x 22 cm;
- material: laminated chipboard in birch effect

A cabinet with compartments for storing standard-sized chamber pots. It will hold 15 pots and together with a 6-shelf extension (NS3226) it will make good use of the small space in a nursery bathroom. The compartments provide ample space for each pot. Doors sold separately.



OCEAN DOORS

Doors for chamber pot storage unit extension

NS3230

- a pair of doors;
- dim.: 48 x 1,2 x 47 cm;
- material: MDF 12 mm in green finish



Doors for chamber pot storage unit

NS3229

- dim.: 48 x 1,2 x 1,6 cm;
- a pair of doors;
- material: MDF 12 mm in white finish



MINTY DOORS

Doors for chamber pot storage unit extension

NS3228

- dim.: 48 x 1,2 x 47 cm;
- a pair of doors;
- material: 12 mm MDF, green;

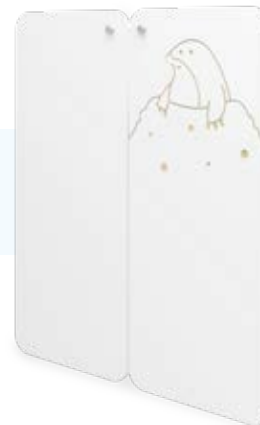

Doors for chamber pot storage unit

NS3227

- dim.: 48 x 1,2 x 1,6 cm;
- a pair of doors;
- material: 12 mm MDF, white



CABINET

Cabinet for pots

NS1843

- dim.: 82 x 38 x 84 cm;
- fits 9 pots



BATHROOM CABINETS & SHELVES



Cabinet for toothbrushes NS2904

Two-level cabinet for 14 toothbrush sets. Underneath plastic double towel hooks. Framework: white. Fronts: blue laminated board.

- dim.: 80 x 12 x 55 cm;
- shelf: 9,5 x 9,5 20 cm;
- fits 14 tumblers and toothbrushes



Bathroom shelf for tumblers and paper towels NS2907

The shelf will hold 14 tumblers and toothbrushes. It also has boxes for paper towels.

- dim.: 198 x 11 x 42 cm;
- material: laminated 18 mm chipboard (birch and light blue)



Bathroom table for tumblers and towels NS2909

This mobile bathroom will hold 16 tumblers and has 8 towel hooks. In the lower part there is a shelf for accessories. The table provides easy access for every child and is equipped with lockable castors.

- dim.: 75 x 42 x 65 cm; 16 hole holders,
- 8 star-shaped hooks, 4 casters (2 with locks);
- material: MDF 12 mm board, laminated 18 mm chipboard

BATHROOM SHELVES

Shelves for accessories essential for dental health.

- will hold toothbrush thumblers;
- plastic handles;
- without tumblers



**Tooth paste
NS2898**

- dim.: 54 x 15 x 17 cm;
- without tumblers



**Brush
NS2899**

- dim.: 53 x 15 x 10 cm



**Bathroom shelf
NS1698**

- dim.: 86 x 37 x 21 cm,
- 6 double hooks



**Cloud
NS2901**

- dim.: 72 x 13 x 30 cm



**Board with hangers
NS2905**

- blue MDF board + yellow plastic double hooks;
- dim.: 124 x 12 x 4 cm;
- 10 double hooks



**Coat hook rail with metal hooks
NS2925**

- dim.: 124 x 4 x 12 cm; 10 double metal hooks

ACCESORIES



**Tumbler
TP1625**

- 8 cm; 1 pc; mix of colours



**Green Towel
NS2652**

- size: 25 x 50 cm

**Yellow Towel
NS2651**

- size: 25 x 50 cm



CHANGING TABLES

WITH STAIRS



Changing table with stairs NS3300

A comfortable and ergonomic changing table with pull-out stairs and storage space for plastic trays (included). They can be selected for colour, number and type according to the user's needs. The construction and functionality of the table make work easy for childminders. Using the stairs with handrails toddlers gain independence in moving around. The stairs have a safety lock against sliding out excessively.

- changing table 112,5 x 72 x 113,5 cm;
- pad 118 x 70 x 3 cm;
- stairs on left (4 steps) 50 x 70 x 85 cm;
- material: laminated chipboard 18 mm,
- MDF 12 mm, colour: birch, blue, white;
- 6 small white plastic trays, 4 big grey plastic trays



FOR STAIRS

Cubo Changing NC0300

Free-standing changing unit with a solid structure, made of durable, high-quality materials. Base construction of the changing unit consists of spacious open shelves for accessories. Open spaces can be equipped with drawers from the Cubo collection and mattresses sold separately.

- dim.: 77 x 140 x 100 cm;
- material: birch



Add-in for the Cubo Changing Unit NC0302

An extra furniture dedicated for Cubo changing unit equipped with shelves for storing nappies and cosmetics for children's care. placed discreetly in the right or left back corner of the furniture.



Stairs for changing unit

Stairs with railings designed for the Cubo changing unit (NC0300). They allow children to step right up on their own. While this solution gives a chance for toddlers to train their skill of climbing the stairs, it facilitates the work of caregivers.

- dim.: 49,2 x 70 x 85 cm; 4 steps;
- material: sides made of MDF board, 12 mm thick, in white; stairs made of chipboard, 18 mm thick



- Blue
NC0303



- Birch
NC0304

Ergonomic mattress for the Cubo Changing Table

Mattress made of polyurethane foam with increased density. Covered with durable, phthalate-free PVC fabric, which is easy to clean. Intended for daily baby care and changing diapers. Raised sides of the mattress increase safety during hygienic activities.

- dim.: 50 x 70 x 15 cm;
- material: polyurethane foam, phthalate-free PVC fabric



Grey
NS3272



White
NS3273

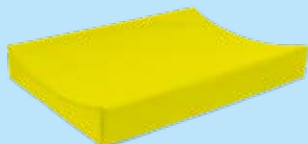

Lemon grass
NS3274

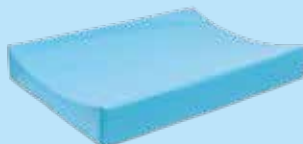

Marine
NS3275

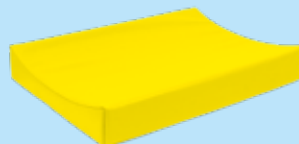

Yellow
NS3276



Pink
NS3277

MINTY

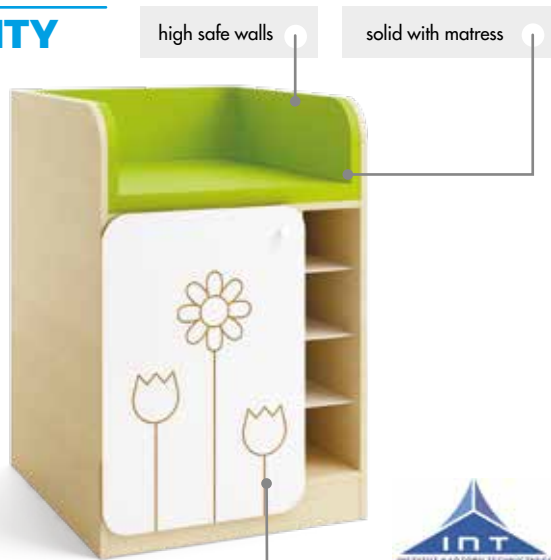

**MINTY Changing unit
NS3207**

- dim.: 67 x 75 x 100 cm



BUTTERFLY



**Changing pad - unit
NS0010**

- dim.: 110 x 75 x 70 cm; sold with mattress



WITH CARDBOARD DRAWERS



Cabinet for changing unit NS1820



Compatible with changing unit NS1819.

- dim.: 58,5 x 38,5 x 81,5 cm

Mat for changing pad NS1906

- dim.: 50 x 70 x 15 cm;
- made of foam covered with durable easy-to-clean PVC cover

Yellow changing unit NS1819

Functional, comfortable and practical changing unit. Equipped with a soft mattress, 4 durable eco cardboard drawers and shelves for keeping necessary accessories. Compatible with cabinet NS1820. Made of laminated chipboard and MDF.

- dim.: 68 x 72 x 97 cm;
- 3 drawers 25,5 x 35 x 17,5 cm and 1 drawer 25,5 x 35 x 8 cm;
- mattress 50 x 70 x 6 cm; needs fixing to the wall

DIAPER CABINET



can be individually signed

Diaper cabinet NS2124

A narrow shelving unit with 20 compartments. Each can hold about 10 nappies. Each shelf can be individually signed for efficient segregation.

- 18 mm laminated board (birch); HDF shelves (white)



TWIN

FOR PLASTIC TRAYS



Double changing unit with compartments for plastic containers NS3301

Functional double changing unit with sturdy frame. It provides space for everyday care and changing diapers. The changing unit has raised sides to ensure safety. The furniture's design offers storage space for plastic trays (sold separately) in which all the necessary accessories can be stored. In our store it's possible to find shallow trays (ex. NS2334) and deep trays (ex. NS2330) in 8 colours with

runners. The high-density foam covered with phthalate-free and easy-to-clean PVC fabric provides comfort and softness. The mattress is available in two colours: white NS3302 and grey NS3303 (sold separately).

- dim.: 103,7 x 71,8 x 107 cm;
- material: base made of chipboard;
- 18 mm thick, in birch colour;
- storage space for 24 shallow trays or 12 deep trays made of plastic;
- the mattress and trays are sold separately



DOUBLE MATTRESS FOR CHANGING UNIT WITH COMPARTMENTS FOR PLASTIC CONTAINERS

Mattress designed for the double changing unit NS3301. The high-density foam covered with phthalate-free and easy-to-clean PVC fabric provides comfort and softness.

- dim.: 100 x 70 x 3 cm; material: PVC fabric in grey or white colour, polyurethane foam

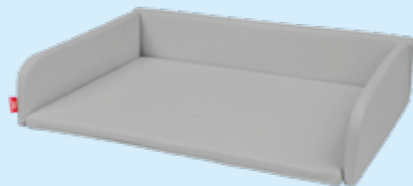

- Grey
NS3303

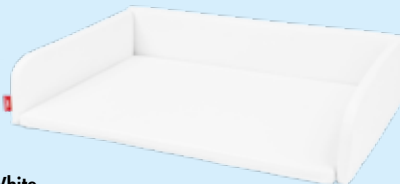

- White
NS3302

SIMPLE**Twin changing unit
NS2128**

A stable twin changing unit with raised back edge for protection. Between the mattresses there is a compartment for diapers, tissues and body care cosmetics. Underneath the top there is room for a clothes basket or a diaper pail. Both stations are adjusted in size to our pads.

- side height 92 cm, top height 87 cm, depth 70 cm;
- total height of the table with the protective back 110 cm;
- width 138,5 cm;
- colour: birchwood; mats sold separately

**Changing mat - Green
NS2123**

Made of foam covered with durable easy-to-clean PVC cover.

- dim.: 50 x 70 x 15 cm

**TOILET ACCESORIES****Toilet seat cover
BT0016**

Practical seat cover which is light and easy to clean. It facilitates the process of learning how to use the toilet. When folded, it doesn't take up a lot of space and can be carried in a bag or a backpack.

- 1 pc; dim.: 35 x 26 cm; weight: 0,5 kg;
- colour: blue; material: polypropylene; age: 3+

**Non slip white stool
BT0017**

Practical stool which helps children to be more independent during their everyday routine. It allows them to use the toilet, wash hands or reach their favourite toy. The stability of the stool is ensured by non-slip elements on the bottom of the product and on its surface. It is made of plastic and because of that it can be carried by a child.

- dim.: 36,5 x 25 x 13 cm;
- material: polypropylene, thermoplastic rubber;
- colour of the stool: white;
- colour of the dots is sent at random, age: 3+



MIRRORS

Mirror decorations to be fixed on the wall 



Sun
NS1663

- dim.: 40 x 40 cm



Cloud
NS1664

- dim.: 59 x 43 cm



Flowers
NS1665

- ø flower 40 cm, pot 30 x 20 cm, 4 pcs



Mirror 1
NS3064

- dim.: 60 x 120 cm



Mirror decorative elements

Colour laser-printed fairytale-theme decorative element made of from plywood. Sold without mirror.

Fish
NS3065

- fish 20 x 21,5 cm;
- foil 60 x 27 cm

DESINFECTION



Contactless hand disinfectant dispenser with a pedal NS3334

The stand for soap dispenser or disinfectants will work perfectly in public institutions. Thanks to the foot-operated dosage button, it ensures contactless use. Solid steel base guarantees stability. Any container with a top-operated dispenser can be placed in the soap dispenser.

- height: 1,2 m;
- material: steel;
- colour: black



Container with contactless dispenser NS3343

- vol. 500 ml, height 21 cm;
- bottle colour: milky, dispenser colour: white;
- material: plastic



Ozone generator NS3335

Ozone generator is a professional device for the most effective air purification, ozonation and disinfection. It destroys viruses, bacteria, mold spores and removes unpleasant odors in a room ranging from 120 to 140 m². The generator produces ozone in the amount of 28 g / hour. Thanks to its compact size, it can be easily transported. The built-in timer allows the device to work at the desired time without being constantly supervised.

- dim.: 20 x 13,5 x 13,5 cm, weight: 1,9 kg;
- ozone output per hour: 28 g;
- power supply: 220 V;
- power: 120W;
- european plug; noise level: 30-40 dB;
- material: stainless steel, ceramic ozone generator inside;
- service life: 3-5 years

DINING ROOM AND KITCHEN

MASTER KITCHEN FURNITURE COLLECTION COMING SOON



MOBILE CABINET



Mobile cupboard NM4030

The cupboard is available in two variants: open space or with a pair of doors for the lower part. The upper part has three shelves with guards to prevent cups and plates from sliding off. The lower part is divided with three permanent shelves. Thanks to four casters the cupboard can be moved around easily and safely. It

was made of high-quality laminated chipboard with ABS edging. The lower shelves and doors are made of white laminated board and the body is in birch effect.

- maximum load: 80 kg;
- total dimensions: width 87 cm, depth 66,5 cm, height 151,5 cm;
- closed space dim.: width 67,2 cm, depth 66,5 cm, height 81,4 cm;
- doors sold separately

Dining room tables are available on page 234 and 242



Doors for mobile cupboard NM4031

Laminated chipboard in white finish

- dim.: 70 x 1,8 x 41 cm



HIGH CHAIRS



High chair for babies FB0002

An ergonomic high chair in subtle colours. The chair is equipped with 6 adjustable height levels, a safety harness, a 3-level backrest position adjustment, a double tray with 3 setting options and a 3-level footrest adjustment. The cushion is made of PVC or PU.

- dim.: 79 x 83 x 106,5 cm;
- dim. when folded: 53 x 28 x 100 cm;
- weight: 8,9 kg;
- colour: mint or light blue – sent randomly



Plastic baby high chair NS2271

Functional high chair, easy for cleaning and moving.

- size.: 73 x 61,5 x 98 cm



low chair with table



chair with table

Baby high chair with table FB0003

- multi functional baby high chair with table;
- material: white sponge, double lamination;



high chair with table

- density: 16 outer part: 0,5 cm, others: 1 cm;
- padded seat, removable for washing;
- seat back adjustment;
- adjustable snack tray



Plastic baby high chair BT0018

Functional high chair, easy for cleaning and moving.

- size: 73 x 61,5 x 98 cm



DISHES

MELAMINE

SETS



Melamine dishes in beautiful colors are light and safe for children. Durable, resistant and unbreakable. Can be washed in a dishwasher at 70° C.

Practical no-spill sippy cup which helps the child to learn independent drinking. It is equipped with a mouthpiece to prevent liquid from spilling and two easy grip handles to ensure comfort. The cup consists of two elements: a liquid container and a lid with a mouthpiece to facilitate the cleaning process.



Melamine Mug NS9100

- dishwasher-safe up to 70°C;
- vol. 250 ml; colour: white



Melamine dish set for 5 children (35 pcs.)

- mug shallow plate; deep plate; dessert plate; fork; knife; spoon

● NS9110	blue
● NS9120	green
● NS9130	orange
● NS9140	yellow



No spill sippy cup

- dim. of the cup: height: 6,5 cm, ø 7 cm; vol. 200 ml

● NS9109	blue
● NS9119	green
● NS9129	orange
● NS9139	yellow



Dessert plate

- vol.: 200 ml; ø 15 x 2 cm

● NS9191	blue
● NS9192	green
● NS9193	orange
● NS9194	yellow



Shallow plate

- vol.: 440 ml; ø 19,8 x 2,7 cm

● NS9111	blue
● NS9112	green
● NS9113	orange
● NS9114	yellow



Deep plate

- vol.: 400 ml; ø 16,3 x 4,8 cm

● NS9121	blue
● NS9122	green
● NS9123	orange
● NS9124	yellow



Mug

- vol.: 240 ml; ø 7,5 x 10 cm

● NS9101	blue
● NS9102	green
● NS9103	orange
● NS9104	yellow



Spoon

- dim.: 13,6 x 3 x 1,8 cm

● NS9151	blue
● NS9152	green
● NS9153	orange
● NS9154	yellow



Fork

- dim.: 13,7 x 2,5 x 1,3 cm

● NS9131	blue
● NS9132	green
● NS9133	orange
● NS9134	yellow



Knife

- dim.: 13,5 x 0,9 cm

● NS9141	blue
● NS9142	green
● NS9143	orange
● NS9144	yellow



**Melamine Bowl
NS9099**

- dishwasher-safe; vol. 5l, D 302 mm, H 130 mm;



**Melamine Bowl
NS9098**

- dishwasher-safe; vol. 5l, D 254 mm, H 124 mm;



**Melamine Tray
NS9097**

The tray has moulded edges which makes carrying meals easier and prevents objects from sliding off. Made of hygienic and durable melamine and natural bamboo fibre. Water- and temperature-resistant from -10°C to +70°C. Dishwasher-safe.

- materials: 100% melamine, bamboo fibre

MENU



**Menu tapestry
NS1604**

- dim.: 83 x 50 cm

CUTLERY

NURSERY

A cutlery kit for toddlers with an engraving of a lamb and the Nowa Szkola logo. The shapes and sizes of the tools are suitable for little hands. This kit is a perfect addition to the nursery dining rooms.

- 1 pc; lgth. 12,5 cm; material: stainless steel



**Toddler spoon
NS9157**



**Toddler fork
NS9159**



**Toddler knife
NS9158**



PRESCHOOL



**Tea spoon
NS9095**

- 13,5 cm



**Spoon
NS9155**

- 18,5 cm



**Fork
NS9135**

- 17,2 cm



**Knife
NS9145**

- 19,0 cm



SCHOOL



**Tea spoon
NS9096**

- 13,5 cm



**Spoon
NS9156**

- 20,4 cm



**Fork
NS9136**

- 20,7 cm



**Knife
NS9146**

- 22,9 cm



BIBS

Baby bib

- 19,5 x 30 cm;
- collar 25 cm;
- snap fastener

**Blue
NS2649**

**Pink
NS2650**



**Waterproof bib. Pastel
BT0019**

Pastel bib made of soft, light fabric. It effectively protects the child's clothes from getting dirty. Regulated fastener facilitates the process of putting the bib on and off. It is additionally equipped with a big pocket

which can collect pieces of food. The bib is also easy to clean and doesn't take a lot of space when folded. Thanks to these features, it can be used during trips or when travelling.

- dim.: 27,5 x 22,5 cm;
- material: synthetic fabric; age: 1+



SAFETY

TRANSPARENT SCREEN



Transparent antivirus shield.

Mobile screen AWF180

Screen is a perfect solution to create a separate space in a room according to individual needs. It can be also used for recommended health protection in educational institutions, nursing homes or treatment rooms. Thanks to the light steel frame and wheels, the screen can be quickly moved or put in a convenient place. Wide leg guarantees stability, and plastic feet protect floors against damage. The surface of the transparent and elastic

panel is made of smooth thick foil which allows the user to write on it with dry-erase markers and makes cleaning and disinfection easy. It is attached to the frame with Velcro. Screens can be transformed into a partition wall system. Self Assembly Required.

- dim.: 94,5 x 50 x 180 cm;
- material: frame made of grey metal pipes with a diameter 2,2 cm, curtain made of transparent plastic, 0,15 mm thick, dim.: 160 x 94,5 cm;
- 2 wheels diam. 4 cm;
- screens are connected by plastic connectors included with the product – one piece

RADIATOR COVERS

The heat-radiator cover has openings in different shapes, thanks to which the heating of the room is not hampered. Rounded rims in the upper part ensure safety and make them suitable for use in kindergartens and schools. Thanks to the sea inspired applications and colours, the radiators blend in well with any

interior design. Self Assembly Required (mounting elements are not included).

- shapes of the openings: sailboat, seagulls, waves;
- material: MDF board;
- colours: white

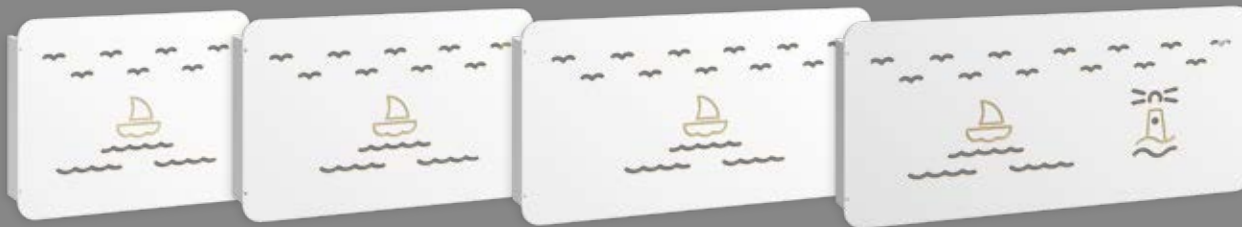

S
NS4121

- dim.: 80 x 62 cm

M
NS4122

- dim.: 100 x 62 cm

L
NS4123

- dim.: 120 x 62 cm

XL
NS4124

- dim.: 140 x 62 cm



FURNITURE & CLASSROOM PROTECTION



Safety lock. Transparent
BT0020

Two-element safety lock which can be easily assembled without any tools. It protects children from trapping their fingers in doors or accessing dangerous objects. The lock is equipped with strong double-sided adhesive tape.

- 1 pc, dim.: 9,6 x 1,3 x 4 cm, weight: 0,05 kg;
- material: PC; colour: transparent; age: 1+

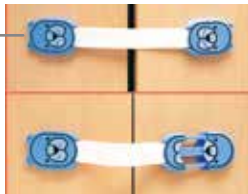

Cabinet safety lock Bear
BT0008

- 1 pc; dim.: 20,5 x 5 x 3,5 cm;
- fastening: double-sided adhesive tape;
- colour: white and blue; material: ABS, PV

FOAM EDGE PROTECTOR

Furniture protectors keep little children safe from injuries. When learning to walk or playing freely, they need a safe environment and so sharp furniture edges need to be covered. Our protectors are made of various materials (foam, silicon, PVC), come in various shapes and colours and can be easily fastened with self-adhesive tape.

- dim.: 3,5 x 1,2 cm; L 2 m; U-shaped; material: NBR;
- fastening: double-sided adhesive tape (not included)



Cabinet safety catch Whale
BT0009

- 1 pc; dim.: 10,2 x 6 x 1,5 cm;
- material: ABS;
- fastening: double-sided adhesive tape; colour: white



Grey
BT0001



Dark blue
BT0002



Light blue
BT0003

CORNERS

- 4 pcs;
- fastening: double-sided adhesive tape



Silicon (transparent)
BT0004

- dim.: 3,5 x 3,5 x 2 cm;
- material: PVC



Foam (grey)
BT0005

- dim.: 6 x 3,5 x 1,2 cm;
- material: NBR



Foam (dark blue)
BT0006

- dim.: 6 x 3,5 x 1,2 cm;
- material: NBR

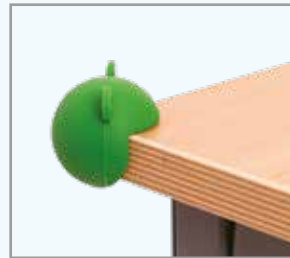

Silicon corners (frogs)
BT0007

- 2 pcs; dim.: 4,5 x 4 cm;
- material: silicon;
- fastening: double-sided adhesive tape; colour: green





**Door handle protector
BT0010**

- 1 pc; dim.: 21 x 3 cm;
- material: EVA foam; colour: eggplant



Doorstops are fast and simple solutions to how to protect little fingers from injury. They prevent doors from slamming shut and walls from getting stained. Available in various shapes and colours. Made of PVC, EVA foam or TPR.

**Animals
BT0011**

- dim.: 15 x 2 cm; material EVA foam;
- shapes: koala, dog, cat;



**Safety socket cover
BT0013**

A plug socket cover for wall sockets and power strips. Easy to use and removable only by an adult (by pulling a lever).

- fits sockets with or without an earth pin;
- 8 pcs; material: plastic, dim.: 3,5 x 2,3 cm



**Doorstop Little Foot
BT0012**

- 1 pc; dim.: 11,5 x 8,2 x 2,8 cm; material: TPR;
- fastening: double-sided adhesive tape; colour: grey



A draught stopper for doors and window sills in the shape of an animal with an elongated body and made of material pleasant to the touch. It prevents from cold air draughts.

- material: velour;
- contents: polycotton;
- hand washable at 30 degrees;
- dim.: L 79 cm, D 7,5 cm, H 17,5 cm;
- age: 0+

**Mouse
NS2080**



**Raccoon
NS2079**



**Tool set
NS9000**

- 19 pcs



**Furniture anchor
TBZ0001**

- Used for securing taller furniture to the wall.
- 2 anchors, 6 screws



**Doggie draught stopper
NS2081**

A doggie-shaped stopper to prevent a door from slamming shut. Very stable thanks to its weight and size.

- dim.: 25 x 26 x 31 cm; weight 1 kg; colour: brown;
- material: plush; hand washable at 30 degrees

WALL BOARDS & DISPLAY

WHITE MAGNETIC BOARDS



WHITE BOARD

- material: aluminium with lacquer coating;
- filling: pressure-resistant and relatively lightweight specific construction made of robust corrugated cardboard
- fixing: to be hung on the wall with wall plugs

- big YC9000

- size: 180 x 100 cm;
- fitted with a pen tray

- small YC9002

- size: 100 x 80 cm



Advertising board YC9005

- with paper;
- size: 100 x 70 cm



White board on wheels - big YC9001

- two-sided, magnetic, dry-wipe;
- board dim.: 180 x 100 cm;
- total dimensions: 80 x 58 x 175 cm;
- material: aluminium with lacquer coating, filling: pressure-resistant and relatively lightweight specific construction made of robust corrugated cardboard
- fitting: possible mounting on a trolley frame



White board on wheels - small YC9003

- dim.: 120 x 90 cm
- board material: surface - varnished steel board, centre - honeycomb filling, pressure-resistant and relatively lightweight construction made of durable cardboard, back - galvanised, board thickness: 16,7 mm
- frame material: frame is made of aluminium and the corner is made of ABS plastic, frame thickness: 19,5 mm;
- tube thickness: vertical: 30 x 50 x 0,9 mm, horizontal: 20 x 40 x 0,9 mm



GREEN MAGNETIC BOARDS

A board is an indispensable part of every classroom. It is a symbol of school and education, and because of it, the quality really matters. In our offer, you can find different variants of the classic board.

- material: honeycomb particle board, lacquered galvanised steel, aluminium;
- fastening: for hanging on the wall;
- equipped with a gutter

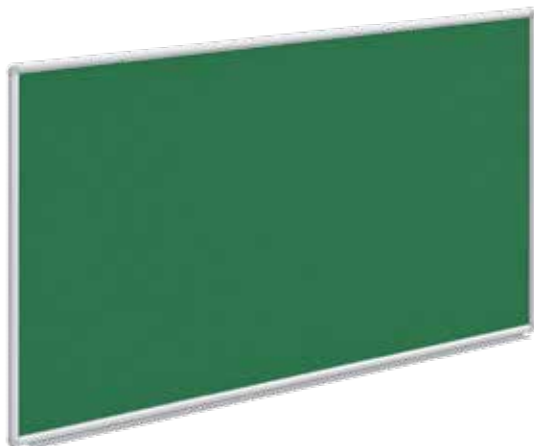

**Green board. Single
YC8000**

- single green board;
- dim.: 100 x 170 cm



**Green board. Triptych
YC8001**

- triptych board in green colour;
- dim.: 100 x 340 cm



**Green board with lines and squares
YC8002**

- triptych board in green colour;
- movable parts with two patterns: grid and lines;
- dim.: 100 x 340 cm



TEXTILE BOARDS



Textile board (dark blue)
YC9008

A cork bulletin board covered with fabric and enclosed in an aluminium frame. Rounded corners with ABS finish for safety. Back reinforced with galvanized tin. Comes with hangers.

- dim.: 150 x 100 cm; colour: dark blue;
- materials: aluminium, galvanized tin, cork, fabric, ABS

PIN BOARDS

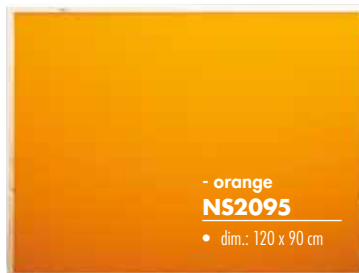

- orange
NS2095

- dim.: 120 x 90 cm

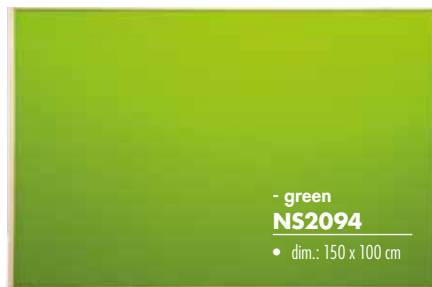

- green
NS2094

- dim.: 150 x 100 cm



- blue
NS2093

- dim.: 200 x 100 cm

SHOWCASE AND TROPHY CABINET



**Showcase with door, cork inside
YC9007**

Display case. The structure is made of aluminum in light grey color. 1 door made of 0.5 cm thick tempered glass.

closed with a lock. The door opens upwards, closed with a lock. Cork inside. Reinforced corners made of ABS material.

- dim.: 150 x 103 x 1,2 cm



**Showcase with door, magnetic inside
YC9004**

- size: 100 x 70 cm



**Trophy cabinet
NM6300**

- dim.: 92 x 30 x 84 cm;
- 3 height-adjustable shelves;
- glass doors with a lock;
- material: laminated chipboard in birch effect



**Display unit
NS0480**

Display's structure is made of chipboard in birch color, 18 mm thick. Application made of cork. The display has 2 shelves made of 18 mm thick chipboard in the color of birch.

- 4 fabric storage pockets and two display shelves;
- dim.: 80,5 x 53 x 172 cm

ACCESORIES



**Nowa Szkoła Wall Clock
NS2008**

- ø 30 cm, 1 AA battery (not provided)



WALL STICKERS

Wall and furniture stickers are easy to peel off without breaking, however, it is important to place them on a clean and dry surface in a way which prevents air bubbles from getting trapped.

- single use; flame-retardant;
- stickers are in different sizes;
- material: foil



Fairy-tales. Wall stickers
NS2982

Wall and furniture stickers depicting fairy-tale characters, animals, and nature.

- 27 stickers;
- dim. of the sheet: 100 x 170 cm



Safari. Wall stickers
NS2983

Wall and furniture stickers depicting animals and safari nature.

- 17 stickers;
- dim. of the sheet: 100 x 170 cm



Happy Animals. Wall stickers
NS2984

Wall and furniture stickers depicting animals and nature in pastel colours.

- 21 stickers;
- dim. of the sheet: 100 x 150 cm

MEDICAL OFFICE

Metal cabinets with lockable glass doors and a metal desk with a fireproof top can be used in a biology lab and the doctor's office. All metal parts are powder coated for enhanced resistance to corrosion, chemicals, high temperature and mechanical damage.



Filing cabinet
NG3004

- dim.: 45 x 62 x 133 cm;
- 4 jumbo drawers;
- central lock



Cabinet
NG3002

The body of the cabinet is made of 0,7 mm power-coated steel. Upper part - glass door with lock; lower part - steel door with lock. Movable metal shelves.

- dim.: 90 x 40 x 185 cm

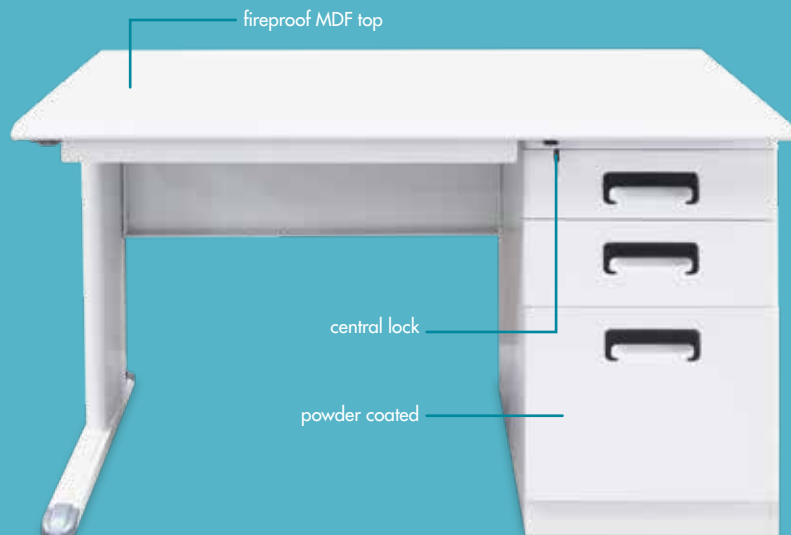

Desk
NG5001

White metal desk with 3 drawers and a keyboard tray. Laminated fireproof MDF top (white; T 2,5 cm). All other elements are made of 0.7 mm steel and powder coated.

- dim.: 120 x 70 x 75 cm

SOFT SEATS

FLAT CUSHIONS



Softplay seats
NS0221

- 12 pcs in 12 colours; dim.: 32 x 3 cm;
- foam padding, durable PVC cover



filled with
granulate

Bean bag seats
NS2163

These round poufs will serve as seats when playing on the floor or as chair cushions for more comfort.

- 6 pcs, ø 35 x 4 cm;
- filled with granulate; PVC cover



PVC coated soft foam



**Mobile platform with
softplay seats**
NS2220

A mobile platform from waterproof plywood with 12 round foam seats.

- platform 80 x 39 x 23 cm;
- 12 seats in 12 colours, dim.: 32 x 5 cm
- foam padding, durable PVC cover

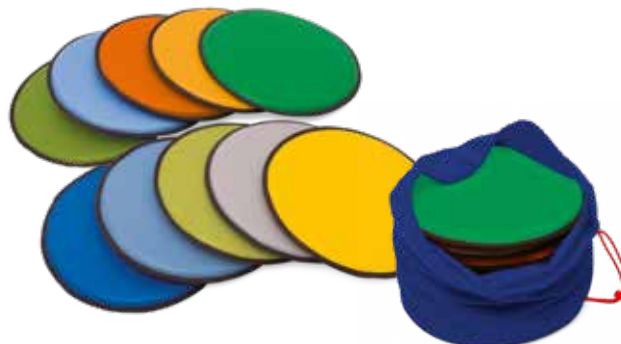

Flat cushions in bag
NS1893

A set of foam discs for sitting on, exercises and for physical educational games. They come in a bag for easy carrying.

- 10 discs in 10 colours with edging;
- dim.: 32 x 2 cm;
- material: artificial leather (PVC);
- filling: foam;
- drawstring bag 34 x 22 cm



Flat foam cushions with a squeaker in a bag NS1894

- dim.: 32 x 32 x 3 cm, with the non-slip PVC cover in yellow, orange, green, marmara blue, white, grey colours;
- filled with polyurethane foam;
- the set consists of 6 pcs;
- weight: 2,5 kg;
- foam cushions made of foam covered with phthalate-free PVC fabric;
- each disc is equipped with a squeaker;
- the trimming is made of reinforced cotton tape ribbon;
- storage: a bag made of oxford fabric in light blue colour;
- closed with a string with a plastic stopper



Soft cushions. 6 shapes NS2299

The set of colourful seats with a wide range of use. Perfect for educational and physical activities or simply sitting. By combining them, it is possible to build an obstacle course or use them in the play corner. The case is made of phthalate-free

fabric which is easy to clean and disinfect. Seats are filled with polyurethane foam with increased density ensuring softness and comfortable use. All elements in the set have rounded edges with a black trim.

- 6 pcs: square 32 x 2 x 32 cm; circle 34 x 2 x 34 cm; triangle 35,5 x 2 x 32,4 cm; pentagon 34,6 x 2 x 33,5 cm; hexagon 35,1 x 2 x 32; star 38 x 2 x 36,4 cm;
- material: polyurethane foam, PVC fabric





**Numbers soft seats
NS0680**

- set of 9;
- ø 32 H 3 cm



**Sea animals soft seats
NS0681**

- set of 3;
- ø 32 H 3 cm



**Animals soft seats
NS0682**

- set of 3;
- ø 32 H 3 cm





**Soft square mats with numbers
NS2298**

Educational mat with printed numbers in the range from 0 to 20. Perfect for floor play and stimulation of cognitive processes. For the youngest, it can be their first experience with numbers. The

PVC fabric free of phthalates and non-slip bottom ensure safety. Polyurethane foam with increased density allows comfortable play time on the floor.

- 21 pcs: dim. of the mat with trimming: 32 x 32 cm;
- material: polyurethane foam, phthalate-free PVC fabric, non-slip PVC fabric;
- even numbers in green, odd numbers in turquoise



**Emotions seats
NS2897**

- foam filling, PVC cover;
- ø 32 cm, H 3 cm;
- 6 pcs (each featuring a different emotion)

PVC coated soft foam



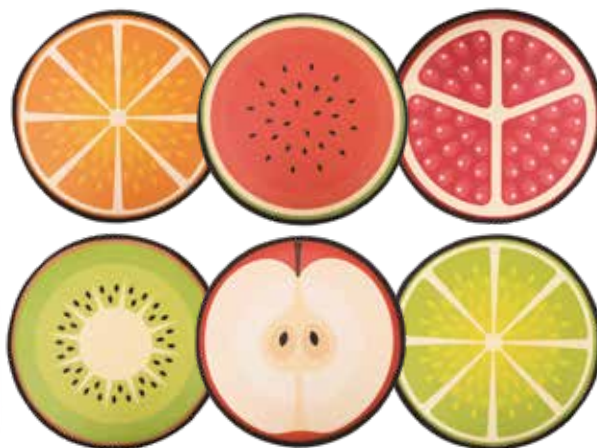

Fruit cushions

NS2236

Soft and comfortable flat round cushions with imprints of slices of different fruits. The cushions are foam filled, trimmed and covered with easy-to-clean PVC material. Besides serving as just seats, they

can be used in various motor and themed activities. Children can freely roll over or spread themselves on them and they have an anti-slip bottom for safety.

- 6 pcs: kiwi, orange, lime, watermelon, apple, pomegranate;
- material: foam, PVC, trimming fabric;
- ø 32; H 2 cm



Nature. Sitting foam cushions in a bag NS2237



- ø 32; H 2 cm;
- with the non-slip PVC cover in white and grey colour;
- filled with polyurethane foam;
- the set consists of 10 pieces with prints;
- weight: 1,3 kg;
- inspired by nature sitting discs made of foam covered with phthalate-free PVC fabric;
- the trimming is made of reinforced cotton tape ribbon;
- storage: a bag made of oxford fabric in cornflower colour;
- closed with a string with a plastic stopper



Jungle cushions

NS2830

A set of 8 foam discs with images of animals will come in useful both during play and educational activities. Interesting motifs on comfortable cushion are likely to be inspirational for children. The discs

are filled with high-quality foam and the PVC cover is easy to clean.

- 8 seats with different printed animals;
- PVC cover with antislip bottom;
- fit the container on casters;
- ø 32; H 2 cm;
- with edging



Roadsigns seats NS2130

- 10 signs foam seats;
- PVC cover;
- fit container on casters;
- ø 32 H 3 cm



Square seats NS1898

- 5 pcs (colours randomized);
- foam filling, PVC cover;
- dim.: 30 x 30 x 10 cm



CONTAINERS

A container ideally fitted to store our round foam seats as well as other toys or blocks. Sturdy chipboard base with 4 casters. Polyester-covered HDF walls are fixed to each other and to the base with strong velcros. Additionally, one wall can be lowered when unvelcro'd.



Small NS1933

- dim.: 38 x 38 x 46 cm



Big NS2933

- dim.: 38 x 38 x 80 cm

PILLOWS

BLACK & WHITE PILLOWS

Contrast cushions stimulate and engage the sense of touch and sight of the little ones in a comfortable in a nice way. The soft fabric combined with eye-catching prints boost creativity in children and encourage them to interact with it.



**Square. Contrast cushion
NS3405**

• dim.: 30 x 30 cm



**Star. Contrast cushion
NS3401**

• dim.: 35 x 35 cm



**Flower. Contrast cushion
NS3402**

• dim.: 35 x 35 cm



**Circle. Contrast cushion
NS3403**

• dim.: 35 x 35 cm

**Water drop. Contrast cushion
NS3404**

• dim.: 35 x 35 cm



SOFT PILLOWS

A pillow with soft filling, covered with a nice to touch sensory fabric. Perfect addition to sensory integration rooms and any calming or therapeutic spaces. Vivid colours stimulate children's curiosity and engage the sense of sight while intriguing textures engage the sense of touch and perception.

• dim.: 40 x 40 cm



grey		NS3280
turquoise		NS3281
mint		NS3282
yellow		NS3283
fuchsia		NS3284
heather		NS3285
ecru		NS3286
orange		NS3287
navy		NS3288





PVC

CUBO CUSHIONS

Soft cushion made of high-quality phthalate-free PVC fabric. Outer material is easy to clean and disinfect. Filled with cut pieces of polyurethane foam which provides comfortable support for the child's head. The cushion can be also used as a seat during playing on the floor. Available in different colour variants. Complements furnitures from the Cubo series.

- dim.: 40 x 40 cm;
- material: PVC fabric, polyurethane foam cuttings



Mix colour
NS3270



Grey
NS3262



Lime
NS3264



Yellow
NS3266



White
NS3263



Marine
NS3265



Pink
NS3267

ANIMALS

Soft cushions Penguin, Seal, Octopus and Whale will be ideal for floor play and they will help children quieten down and relax while listening to fairy tales.

- zippered velour cover washable at 30°C;
- various uses: sit on them, lie on them, play with them easy to keep clean (zipped machine washable cover) certified material (velour, cotton wool padding, removable cover)



Penguin
NS2195

- dim.: 65 x 95 cm



Seal
NS2193

- dim.: 70 x 100 cm



Whale
NS2196

- dim.: 140 x 65 cm

SENSORY CUSHIONS

Large and soft cushions mainly for toddlers. The soft snouts, flexible legs and squeaky elements encourage kids to cuddle the toy animals. Made of PVC fabric with velourelements. Stuffed with shredded foam.

- dim.: 70 x 90 cm

soft snouts encourage
kids to cuddle

flexible legs and
squeaky elements



Doggy
NS2108

The dog has a nose that squeaks cheerfully, pellet-filled ears and soft elastic paws.



Bunny
NS2109

The bunny has a tail that squeaks and elastic ears and paws.

PILLOWS

Made of padded foam covered with washable soft fabric, removable zipped cover.

- dim.: 60 x 38 cm



Cat
NS1973



Whale
NS1971



SMALL ANIMALS

Plush, soft, nice-to-the-touch cuddly cushions. Ideal both for play and while resting.

- weight 60 g;
- contents: polycotton;
- material: velour; age 0+;
- 30 degrees washable



Cow
NS2073

- dim.: 25 x 30 cm



Dog
NS2074

- dim.: 25 x 35 cm



Cat
NS2075

- dim.: 25 x 35 cm



Snail
NS2076

- dim.: 30 x 20 cm



Penguin
NS2077

- dim.: 26 x 27 cm



Frog
NS2078

- dim.: 30 x 27 cm



POUFS

SENSORY MANIPULATIVE

SOFT SENSORY POUF

A big, cosy pouf which provides space for relaxation or a variety of sensory integration activities. Thanks to its size and soft filling, the pouf adjusts to the current position of the body. The sensory fabric with insets gently massages hands and feet.

- dim.: 70 x 70 x 35 cm;
- cover: Minky and polyester Oxford fabric;
- filling: foam granules

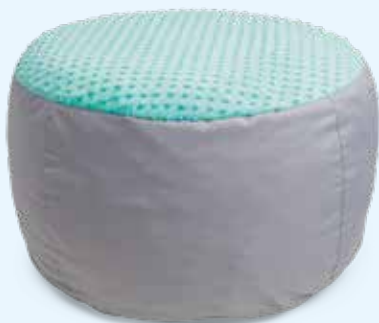

- mint
NS3147



- yellow
NS3148



Calming pouf with pockets
NS2176

A seat in the shape of a pouf with two pockets on the sides. The pockets have a therapeutic function, allowing the child to calm down and relax.

- dim.: 32 x 30 x 32 cm, seat height 32 cm;
- cover: phthalate-free, abrasion-resistant PVC fabric in green
- filling: highly resilient polyurethane foam



FANTASY

ANIMAL POUFS

• ø 35, H 30 cm



Hen
NS1978



Pig
NS1974



Frog
NS1975



Cat
NS1976



Cow
NS1977



Red Sprite
NS2141

velvet cap can be used as a pocket



**Rainbow caterpillar
NS1992**

- set of 7 elements;
- ø 35 x 30 cm



**Clever kidney-bean
NS1970**

- 5 pcs;
- height from 14 to 42 cm



BOLSTERS ANIMALS

- size: 50 x 24 x 29 cm;
- high-density foam;
- anti-skid bottom;
- easy-to-clean pvc cover;
- ears squeak when pressed;
- age: 6 m+



**Bear
NS2118**



**Lion
NS2119**



**Frog
NS2120**



**Giraffe
NS2121**

BIG POUFS



Seat Carrot
NS2213

- dim.: 99,3 x 49,5 x 26 cm;
- foam padding, printed PVC cover



Seats Llama and Fox

Llama and Fox are colourful, comfortable, springy seats will create a joyful attractive play corner in a nursery school. Their simple construction and right choice of materials ensure comfortable and safe use. The PU foam

padding guarantees softness and durability and the PVC easy-to-clean covers are nice to the touch. The animal symbols are printed.

Dimensions:

- fox: 73,5 x 28 x 53 cm;
- llama: 71 x 28 x 75 cm



Llama
NS2227



Fox
NS2228





**Caterpillar
NS2229**

The seat will additionally make an attractive element in gymnastic exercises, play and relaxation. The high-durability PU foam padding ensures high resistance to pressure and provides comfortable sitting. Easy-to-clean PVC cover.

- dim.: 119 x 25 x 40 cm

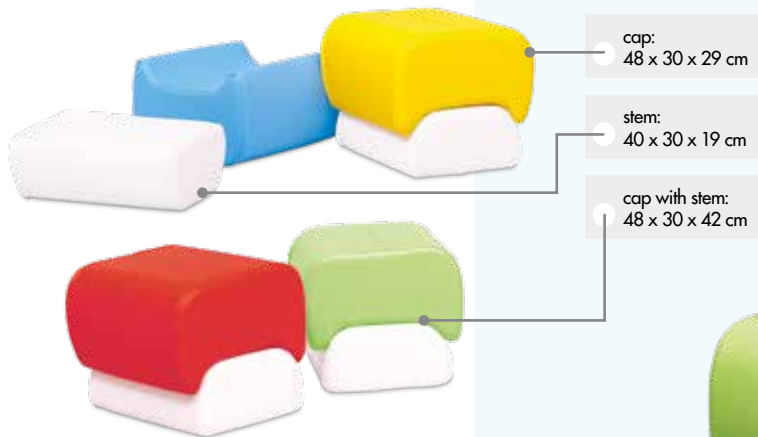

cap:
48 x 30 x 29 cm

stem:
40 x 30 x 19 cm

cap with stem:
48 x 30 x 42 cm

**Mushrooms
NS1901**

A furniture set of the modules and tables. A seat on top of a table forms a mushroom. The construction and the elements are stable, comfortable and practical.

- 8 pcs made of foam covered with PVC fabric;
- designer Tomasz Huszczo



wide variety of
configurations

BEANBAGS

SMALL



REHAB BEAN BAG

Helps in developing movement coordination.

- dim.: 60 x 100 cm;
- filled with granulate;
- covered with heavy-duty fabric

– Oxford

- weight: 2,3 kg

NS0639 rainbow

– PVC

- weight: 2,6 kg

NS0639T rainbow

NS0639NI blue

NS0639ZI green

NS0639ZL yellow

NS0639PO orange

NS0639CZ red

NS0639RO pink

BIG PVC

REHABILITATION CUSHION

- dim.: 110 x 100 cm;
- weight: 6 kg

	NS0585BS	white-grey
	NS0585T	rainbow
	NS0585	blue
	NS0585NI	light blue
	NS0585ZI	green
	NS0585ZL	yellow
	NS0585PO	orange
	NS0585CZ	red
	NS0585RO	pink



PVC WITH HANDLES

The rehabilitation cushion is intended for rehabilitation and gymnastic exercises. Additionally, it works perfectly as a seat. Filled with granulate which helps it to adjust to the shape of the body, making the resting time more comfortable. Equipped with a convenient handle which allows the cushion to be moved. The lightness of the product and the phthalate-free PVC fabric makes it possible to use outdoors.

- dim.: 107 x 90 cm;
- weight: 5 kg;
- material: polystyrene granulate, PVC fabric;
- colour: white-grey or lime-black



**Lime-black
NS2230**



**White-grey
NS2294**



Successful rehabilitation requires good quality functional equipment. Foam shapes are standard tools necessary for the implementation of therapy. We offer them in many different shapes and sizes. Their inside is made of polyurethane foam, covered with an aesthetic phthalate-free PVC fabric in various colours. Thanks to foam shapes, the users can effectively train the upper and lower parts of their bodies. Pear-shaped cushions are great for sitting and exercising. They adapt perfectly to the position of the body, and they can be formed according to the needs of the user. Additionally, they can prove

useful during rehabilitation and other therapeutic activities. However, they are also perfect as a comfortable seat. Some models are equipped with a handle which makes moving them from one place to another much easier. Their quality design, high quality granules and durable PVC or Oxford fabric guarantee long service life. Styrofoam granules, which can be found inside pear-shaped cushions and other rehabilitation cushions, wear out naturally after about a year of intensive use. We recommend refilling the cushions with new granules which you can find under the code: NS1585.

Big pear-shaped rehabilitation cushion

- dim.: 135 x 100 cm;
- weight: 7,5 kg



**Grey with a handle
NS3320**

- styrofoam granules; colour: two shades of grey

**Beige and grey with a handle
NS3321**

- styrofoam granules; colour: beige - grey

OXFORD

- dim.: 110 x 100 cm;
- weight: 5 kg



**Green black grey
NS3310**

- styrofoam granules; colour: green-black-grey

**Blue black navy
NS3311**

- styrofoam granules; colour: blue - black - navy



FRUITS

- dim.: 60 x 50 x 28 cm;
- foam-pellet padding;
- cover: PVC fabric



Strawberry
NS2214



Aubergine
NS2215



Pear
NS2216



SMILEY FACES

Smiley beanbags

- made of colourful PVC filled with polystyrene beads;
- ø 65, H 63 cm;
- weight: 3 kg



Green & yellow
NS1889



Green & dark green
NS1890



Blue & pink
NS1891



Dark blue & orange
NS1892



ANIMALS

Animal beanbags

- dim.: 60 x 52 x 28 cm;
- weight: 2,2 kg



Blue Penguin
NS1985



Duck
NS1986



Black Penguin
NS1987



Purple Seal
NS1988



Tiger
NS1989



Blue Seal
NS1990

SENSORY

SENSORY CUSHIONS

Large and soft cushions mainly for toddlers. The soft snouts, flexible legs and squeaky elements encourage kids to cuddle the toy animals. Made of PVC fabric with velourelements. Stuffed with shredded foam.

- dim.: 70 x 90 cm



Doggy
NS2108

The dog has a nose that squeaks cheerfully, pellet-filled ears and soft elastic paws.

Bunny
NS2109

The bunny has a tail that squeaks and elastic ears and paws.

SENSORY PEARS

Comfortable pouffes with sensory elements (bells, pipes, velcros, string loops, laces). Made of PVC fabric. Filled with styrofoam, they can easily adapt to the sitter's position.



Clown
NS2106

The clown has a soft velour cap, loopy hair, long arms with a bell, laced shoes, large buttons and a red nose which squeaks cheerfully when pressed.

- dim.: 100 x 90 cm; weight: 6 kg

Teddy Bear
NS2107

The bear has soft velour ears, squeaky nose and long velcroed arms with which to hug anyone who sits down on him.

- dim.: 100 x 90 cm;
- weight: 6 kg



POLYSTYRENE GRANULATE



Foamed polystyrene granulate
NS1585

- 1 kg; a cover made of non-woven fabric with a zipper



BIG CUSHIONS

Soft, thick pillows in the shape of animals. They will revive the interior of nurseries or kindergartens thanks to their colours. The use of sensory materials will encourage children to physical activity and it will develop their

sense of touch through play. They will also provide a comfortable place to rest. Each animal was filled with polyurethane foam covered with a different soft fabric ensuring comfort and safety. Removable cover



Sheep pillow
NS2243

- dim.: 185 x 145 x 20 cm;
- material: fabric imitating sheep's wool in light grey, white fleece;
- filling: cut pieces of polyurethane foam



Turtle pillow
NS2245

- dim.: 180 x 153 x 20 cm;
- material: light and dark Turquoise-coloured fleece;
- filling: cut pieces of polyurethane foam

CONTRAST CUSHION

perfect to learn how to lie on the tummy, sit down, play and relax

black and white eye-friendly patterns attract attention and train the ability to concentrate

the set consists of 4 contrast cushions

the cushion is warm and comfortable

embossed dots stimulate the sense of touch

More contrast pillows available on page 354



Contrast cushion NS3400

Big cushion designed to stimulate child's senses and motor development. Many of its functions are important for proper development of a child. Black and white eye-friendly patterns attract attention and train the ability to concentrate. It's perfect to learn how to lie on the tummy, sit down, play and relax. Thanks to the use of high quality soft Minky fleece with embossed dots, the cushion is warm and comfortable. Embossed dots also stimulate the sense of touch. Raised sides of the cushion allow

the baby's head to be supported. The product's additional asset is the possibility to remove the arch from the mattress. The cushion is filled with pieces of cut foam which ensure the comfort of use. The set consists of 4 contrast cushions.

- dim. of the cushion: outer diam.: 136 cm, inner diam.: 96 cm, height 20 cm; cover made of Minky fabric in black and white; dim. of the cushions: flower 50 x 9 x 50 cm, circle 48 x 9 x 48 cm, star 53,4 x 9 x 51 cm, water drop 48 x 9 x 57,9 cm; covers of the cushions are made of cotton fabric with printed black and white patterns: black dots, white stars, checker, filling: pieces of cut foam



**Doughnut. Sensory seat
NS2292**

Seat in the shape of a doughnut with icing intended for sensory stimulation. Colorful pieces made of fabrics with different textures and fastened with velcro activate perfectly the sense of touch and sight. The filling in the form of pieces of polyurethane foam,

enables easy and quick adjustment of the seat's shape to the body of a small patient. Phthalate-free PVC fabric and non-slip bottom ensure safe and comfortable usage.

- outer dim.: 120 cm;
- inner dim.: 60 cm;
- 8 pieces fastened with velcro;
- material: Minky fabric, denim, phthalate-free PVC fabric, non-slip PCV fabric, velor fabric



**Activity corners. Flower
NS1907**

Mat made of soft-touch material – drill with foam filling.

- inside 3 removable mattresses; antislip bottom;
- made of durable PVC fabric; ø 140 cm, H 10 cm



SENSORY CUSHIONS TEXTURE

Large flower and lifebelt shaped cushions filled with foam cuttings.

- ø 100 cm, H 20 cm



**Lifebelt
NS2158**



**Flower
NS1885**



**Hippo
NS0220**

Made of padded foam covered with washable denim fabric, removable zipped cover.



**Frog
NS0219**

Made of padded foam covered with washable denim fabric, removable zipped cover.

- ø 100 cm





LULA Soft, square and round cushion, roller and small pillow perfect for therapy corners, sensory rooms and playing area. Its light colour has got a calming effect while the soft filling gives a sense of comfort and security.

- PVC case with a zipper; filling: polyurethane foam granules;
- it is equipped with an inner cover



**Roller
NS1910**

- dim.: ø 120, H 20 cm;
- weight: 2 kg



**Square cushion
PS2126**

- dim.: 120 x 120 x 30 cm;
- weight: 13 kg



**White square cushion
NS3165**

- dim.: 120 x 120 x 30 cm;
- weight: 13 kg

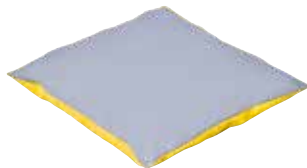

**Small pillow
NS1909**

- dim.: 55 x 55 cm



**Round cushion
NS1911**

- ø 120 cm, H 30 cm;
- weight: 8,5 kg



**White round cushion
NS3166**

- ø 120 cm, H 30 cm;
- weight: 8,5 kg



Butterfly NS1895

- 4 bolsters in different colours;
- size: 140 x 120 cm

Mirror Mat – Flower NS2111

A soft two-piece mat with 5 petal-shaped cushions on top of a round soft foam-filled bottom part. The top piece is wadded and zippered. In the middle of the flower there is a safe Plexiglas mirror (diameter 35 cm).

- ø 145 cm, 10 cm thick;
- age: 6 months +
- cover washable 40°C

mat
ø 145 cm



pillow
with mirror



Bee NS1908

- anti-slip bottom;
- made of denim with foam insert;
- flaps filled with polystyrene beads;
- size: 135 x 115 x 10 cm



MATS



Pizza. Sensory mat NS2293

Sensory mat in the shape of a pizza with pieces of vegetables and bacon fastened with velcro. Thanks to the moving parts the therapeutic work involving stimulation of the sense of sight and touch will be easier and more intense. It will provide children with many hours of creative experiences with different shapes and combinations. Phthalate-free PVC fabric and non-slip bottom ensure safety and comfort of use.

- dim. of the mat with rim: 140 cm;
- 16 pieces fastened with velcro: 2 x tomato, 2 x broccoli, 2 x olive, 2 x pickle, 2 x mushroom, 2 x basil, 2 x bacon, 2 x salami;
- material: denim, velor fabric, phthalate-free PVC fabric and non-slip PVC fabric



Round mattress with pockets and mirrors NS2199

A very comfortable soft mattress for toddlers to roll and crawl freely. The added mirrors stimulate sight, help develop self-awareness and interpersonal social skills. The small pockets will hold illustrations or suggested worksheets for stimulating curiosity and the will to explore. The mattress is padded with soft foam and covered with coloured PVC fabric.

- mattress \varnothing 137 cm x 3 cm;
- 1 round mirror \varnothing 27 cm;
- 3 square mirrors 17 x 17 cm;
- 3 pockets 12 x 12 cm

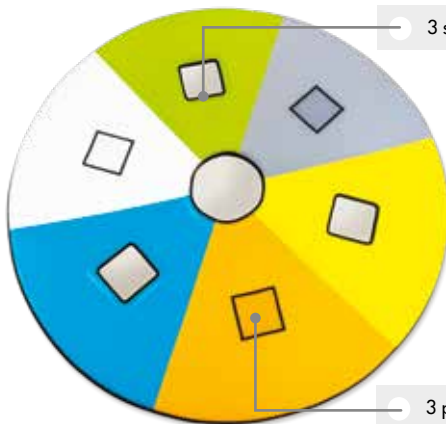

3 square mirrors 17 x 17 cm

3 pockets 12 x 12 cm



Texture Track NS2150

A set of sensory foam shapes for children to arrange.

- made of PVC covered foam;
- 10 squares: 40 x 40 x 3,5 cm;
- 4 quarters: 40 x 40 x 3,5 cm;
- 1 circle: \varnothing 40 cm



2 in 1 fitness frame piano TU0037

This floormat with an interactive piano will grow with the baby. In the first months, when the baby lies on the back it can play with the toys on the arch and press the keyboard keys with its feet. When it starts to lift its head and lie on its tummy, it can face the keyboard. When it has

learned to sit, the piano can be set up in the table position. The keyboard panel can also be detached and mounted onto the bed.

- keyboard with 4 large keys and a function key, 5 rattles with hooks (including 1 music box);
- mat size: 70 x 83 x 45 cm;
- requires 3 AA batteries and 3 AG13 1,5V batteries (not included);
- age: 6 mths+

REST CORNERS & COUCHES

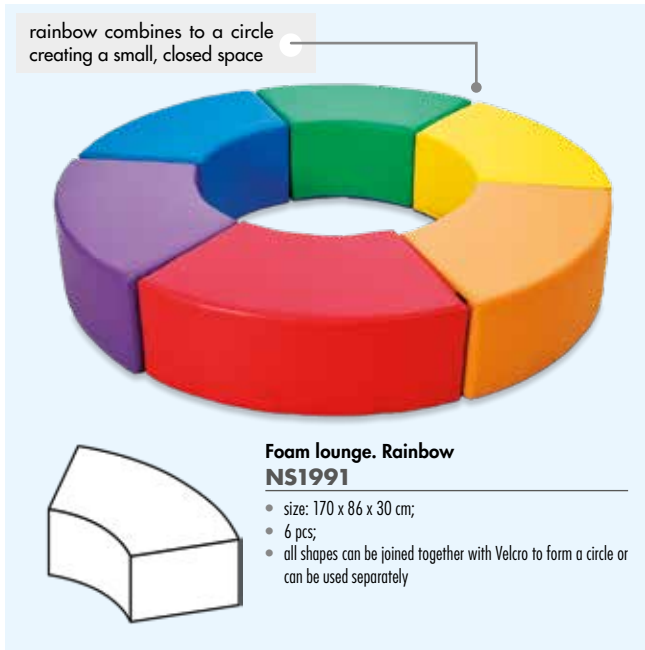
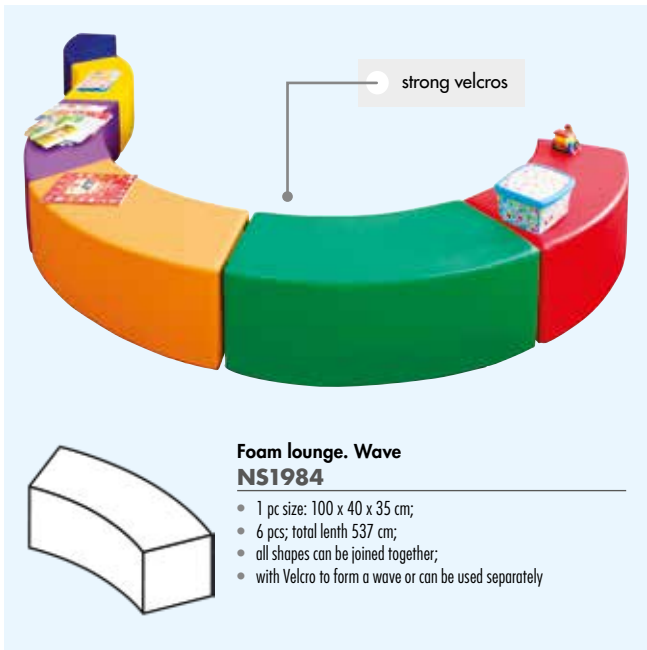

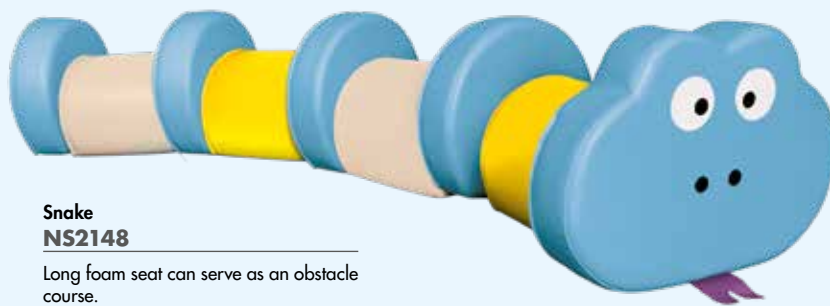

**Snake
NS2148**

Long foam seat can serve as an obstacle course.

- 9 velcro-fastening elements; total length 170 cm



**Flower garden
NS1999**

- dim.: 140 x 140 x 60 cm;
- 12 elements made from foam covered with PVC fabrics

PVC phthalate free

wide variety of configurations

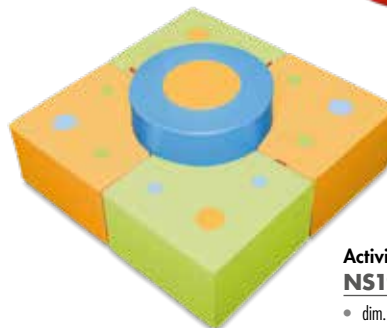

**Activity corner
NS1969**

- dim.: 110 x 110 x 47cm;
- 5 pcs;
- made from foam covered with PVC fabrics

SOFTPLAY ACTIVITY SETS



**Colourful train
NS1937**

- total length 342 cm; 8 elements



**Blue ship
NS1940**

- size: 130 x 70 x 80 cm, 5 elements



**Maxi armchair Olaf
NS0596**

- size: 55 x 45 x 55 cm;
- seat H 25 cm



**Maxi sofa Różyczka
NS0597**

- high density foam covered with PVC fabric;
- size: 90 x 45 x 55 cm



**Lounge suite Dolphin
NS0598**

- 2 armchairs size: 48 x 55,2 (seat height 24 cm);
- table 67,2 x 36 x 24 cm

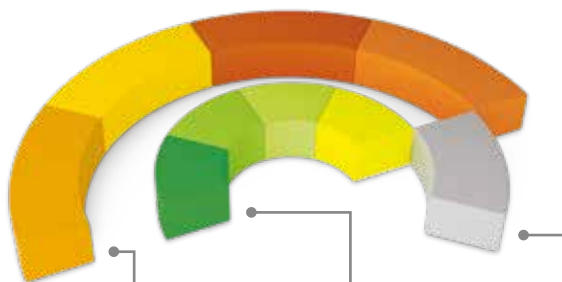

**Foam 1 Sunny
NS2180**

- 4 pcs, 133 x 30 x 45 cm,
- total length: 528 cm

**Foam 2 Green
NS2179**

- 4 pcs, 65,5 x 30 x 45 cm
- total length: 300 cm

**Foam 3 Grey
NS2181**

- 1 pc, 100 x 30 x 45 cm;
- total length: 528 cm

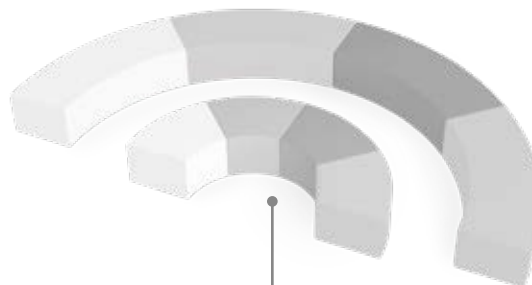

**Foam 1 Black and White
NS2259**

- 4 pcs, 133 x 30 x 45 cm,
- total length: 528 cm

**Foam 2 Black and White
NS2260**

- 4 pcs, 65,5 x 30 x 45 cm
- total length: 300 cm



**Fresh semicircular poufs for
reading corner
NS1745**

- 2 pcs, size: 30 x 92 x 30 cm;
- colour: orange;
- material: PVC, foam



**Fresh Book container rounded
poufs
NS9745**

- 2 pcs, size: 30 x 92 x 30 cm;
- colour: grey;
- material: PVC, foam



**Red Throne Sofa
NS2138**

- size: 101 x 45 x 71 cm;
- seat height 25 cm



**Green Throne
NS2191**

- size: 66 x 45 x 72 cm;
- seat height 26 cm



**Bus
NS2161**

The double sided sofa with a backrest. Will seat up to 8 children

- size: 110 x 90 x 72 cm;
- seat H 25 cm, seat D 33 cm;
- PVC-covered foam

high-density
foam
PVC covered

sides fixed
with strong velcros

non-slide bottom





Lion
NS2137

- size: 81 x 47 x 76 cm;
- seat H 25 cm



Flower
NS2139

- size: 110 x 45 x 76 cm;
- seat H 25 cm





SHEZLONG

Functional seat, which when unfolded turns into a comfortable chaise longue. When folded, it doesn't take up too much space, and if needed, it can create a calm and relaxing space to rest after vigorous games or after a walk. It is perfect for toddlers' corners, reading rooms or common rooms. The seat is made of a high quality, durable PVC fabric, which is easy to clean and disinfect. The inside of the seat is filled with a polyurethane foam with increased density to ensure the comfort of use, while the non-slip surface guarantees safety. Sold in many colours.







- material: polyurethane foam, anti-slip fabric, phthalate-free PVC fabric available in 7 colours

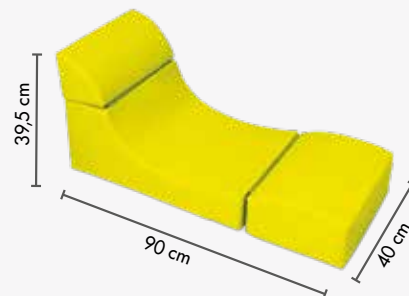
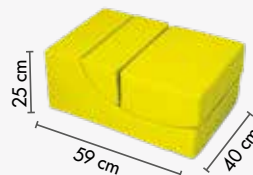

SMALL

- dim.: 60 x 40 x 25 cm
- dim. when folded: 90 x 40 x 39,5 cm



grey		NS3172
white		NS3173
lime		NS3174
blue		NS3175
yellow		NS3176
rose		NS3177
marine		NS3178



MEDIUM

- dim.: 60 x 119 x 52 cm
- dim. when folded: 60 x 79 x 33 cm

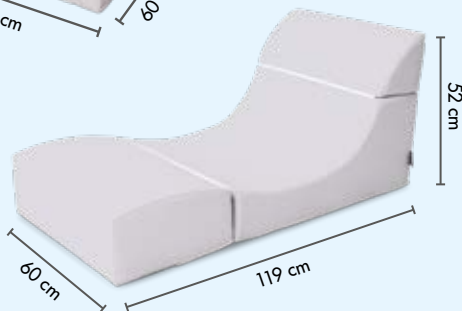

grey		NS4172
white		NS4173
lime		NS4174
blue		NS4175
yellow		NS4176
rose		NS4177
marine		NS4178



LARGE

- dim.: 70 x 150 x 62 cm
- dim. when folded: 70 x 100 x 39 cm

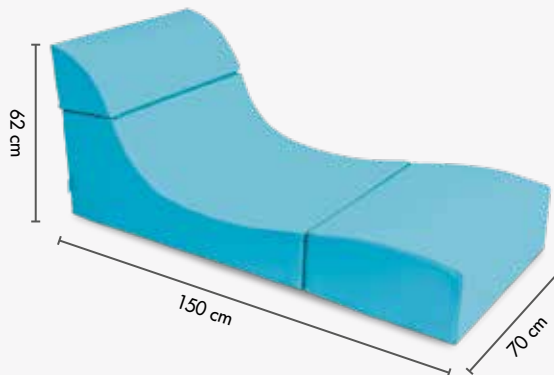
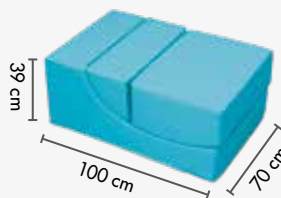

grey		NS5172
white		NS5173
lime		NS5174
blue		NS5175
yellow		NS5176
rose		NS5177
marine		NS5178

SOFAS POUFS & ARMCHAIRS SETS

HEIGHT 25 CM



Sofas

• dim.: 110 x 40 x 45 cm

■	NS1507 0 BL	Ligh blue
■	NS1507 0 CZ	Red
■	NS1507 0 JZ	Yellow
■	NS1507 0 PO	Orange
■	NS1507 0 RO	Pink
■	NS1507 0 ZI	Green



Armchair

• dim.: 35 x 40 x 47 cm

■	NS1508 0 BL	Ligh blue
■	NS1508 0 CZ	Red
■	NS1508 0 JZ	Yellow
■	NS1508 0 PO	Orange
■	NS1508 0 RO	Pink
■	NS1508 0 ZI	Green



Cube

• dim.: 40 x 40 x 25 cm

■	NS1506 0 BL	Ligh blue
■	NS1506 0 CZ	Red
■	NS1506 0 JZ	Yellow
■	NS1506 0 PO	Orange
■	NS1506 0 RO	Pink
■	NS1506 0 ZI	Green
■	NS1506 0 NI	Blue

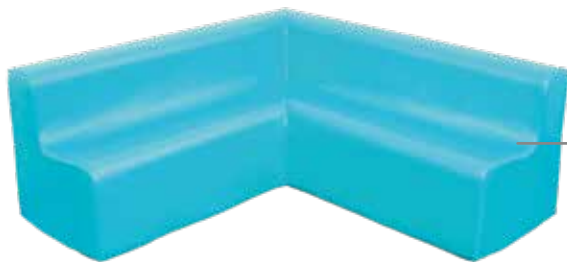

sitting place for
● 5 children

Big corner sofa

• dim.: 110 x 110 x 45 cm

■	NS1529 0 BL	Ligh blue
■	NS1529 0 CZ	Red
■	NS1529 0 JZL	Yellow
■	NS1529 0 PO	Orange
■	NS1529 0 RO	Pink
■	NS1529 0 ZI	Green



HEIGHT 30 CM



Cube shaped poufs with black and white print NS2246

Light, comfortable cubes filled with high-density polyurethane foam covered with phthalate-free PVC fabric in white and black. Thanks to the modern and universal prints they will complement any play corner, classroom or therapy office. The fabric is durable, easy to clean and disinfect.

- 3 pcs with 3 different prints;
- dim.: 30 x 30 x 30 cm;
- material: PVC fabric in white with black prints



HEIGHT 32 CM



Sofas

- dim.: 120 x 52 x 60 cm



Armchair

- dim.: 40 x 52x 60 cm



Pouf

- ø 30, H 32 cm

■ NS1502BL	Light blue
■ NS1502CZ	Red
■ NS1502JZ	Yellow
■ NS1502PO	Orange
■ NS1502RO	Pink
■ NS1502ZI	Green

■ NS1504BL	Light blue
■ NS1504CZ	Red
■ NS1504JZ	Yellow
■ NS1504PO	Orange
■ NS1504RO	Pink
■ NS1504ZI	Green

■ NS1501BL	Light blue
■ NS1501CZ	Red
■ NS1501JZ	Yellow
■ NS1501PO	Orange
■ NS1501RO	Pink
■ NS1501ZI	Green

Comfortable and practical seats with colourful prints of the crayons. They complement perfectly changing room or corridor spaces. They can be also used during gymnastic exercises or rehabilitation. Made of durable polyurethane foam with increased density, ensuring comfort while sitting. Phthalate-free PVC fabric is easy to clean and disinfect. The non-slip bottom ensures safety and stability during activities.

- material: polyurethane foam, PVC fabric in grey, with crayons print;
- non-slip bottom



Crayons seat – cube NS3162

- dim.: 38 x 38 x 32 cm



Crayons seat – round NS3163

- dim.: 38 x 38 x 32 cm



Crayons seat – semicircular NS3161

- dim.: 49 x 38 x 32cm

HEIGHT 38 CM



Cube

• dim.: 36 x 36 x 38 cm

NS1540PO

NS1540B

Sofa

• dim.: 134 x 59 x 69 cm

NS1538SZ

Armchair

• dim.: 44 x 59 x 69 cm

NS1537ZI

Pouf

• ø 35 cm, H 38 cm

NS1539NI

NS1539B

HEIGHT 45 CM

SEAT

• dim.: 120 x 45 x 45 cm

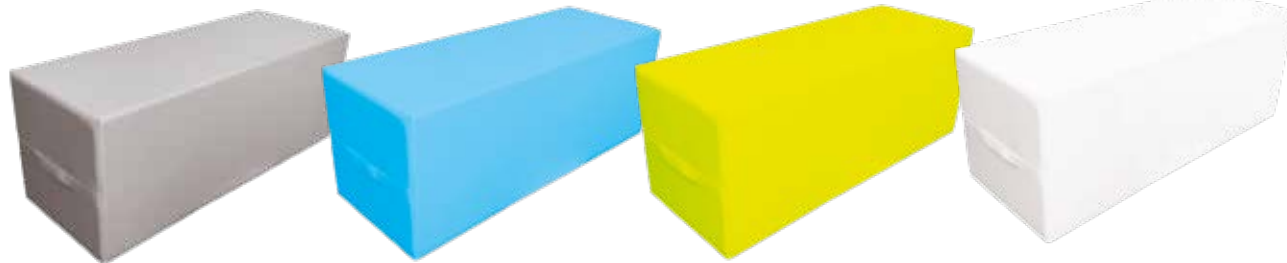

- grey
NS2284

- marine
NS2285

- lime
NS2286

- white
NS3170



ADULT COUCHES

Comfortable, upholstered line of couches covered with a highly abrasion-resistant polyester fabric in 2 sets of colours. Gentle hand wash.



Pouf - table

- dim.: ø 75 cm, seat's height 40 cm

NS8143



Armchair

- dim.: 80 x 80 x 62 cm; seat's height 40 cm

NS8142



Sofa

- dim.: 140 x 80 x 62 cm; seat's height 40 cm

NS8141

Navy



Beige



NS8153

NS8152

NS8151



CARPETS

HEAT SET FRISE

Carpets made in Heat-SET frize technology are characterized by high density, tall bristles. The pile of the carpet, thanks to the special, notched weave of threads is soft to touch, comfortable in use and it resembles wool. The fibers are antistatic, deformation and wear resistant. The anti-bacterial carpet pile prevents the ingress of dirt into the deep bristle structure. The carpet is additionally covered with a flame-retardant coating to ensure safety. The jute fabric underneath the carpet protects the floor from scratching and makes it suitable for use with underfloor heating. They are easy to clean and allergy friendly. Carpets with the Polish Hygienic Certificate are free from harmful chemicals.

Parameters.:

- the pile +/- 13mm, weight +/- 2400 g/m²,
- material: 100% PP Heat set



2x3 M

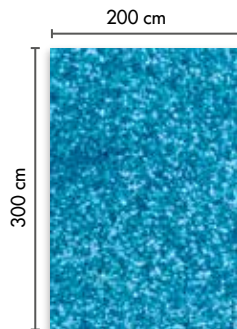

RECTANGLE 2X3 M

DL0022	Grey
DL0042	Green
DL0052	Orange
DL0032	Blue
DL0012	Beige

3x4 M

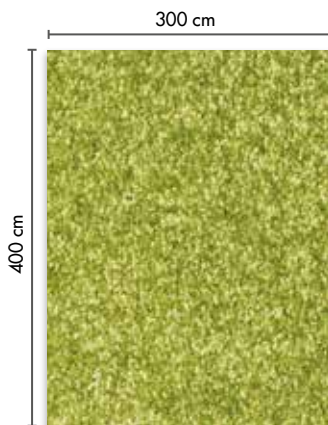

RECTANGLE 3X4 M

DL0023	Grey
DL0043	Green
DL0053	Orange
DL0033	Blue
DL0013	Beige

4x5 M



RECTANGLE 4X5 M

DL0024	Grey
DL0044	Green
DL0054	Orange
DL0034	Blue
DL0014	Beige

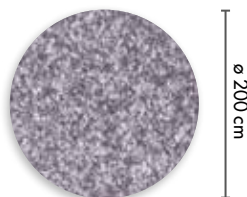
DIAMETER 2 M**ROUND 2 M**

DL0122	Grey
DL0142	Green
DL0152	Orange
DL0162	Blue

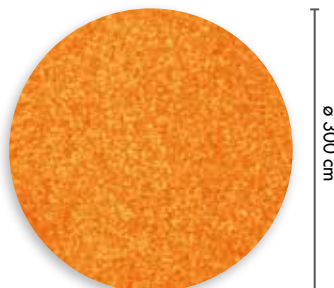
DIAMETER 3 M**ROUND 3 M**

DL0123	Grey
DL0143	Green
DL0153	Orange
DL0163	Blue

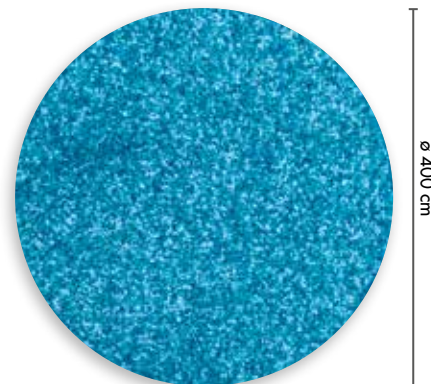
DIAMETER 4 M**ROUND 4 M**

DL0124	Grey
DL0144	Green
DL0154	Orange
DL0164	Blue

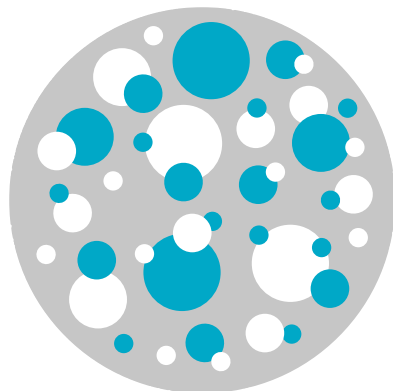
WITH PATTERN
Round carpet with circles 3 m
DL0503

- ø 3 m; round;
- colour: grey with blue and white circles



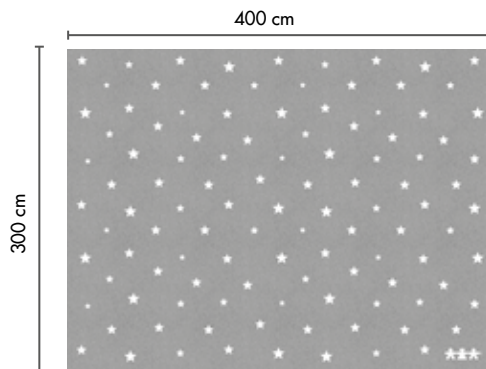

**Grey stars carpet
DL0501**

- grey carpet with white-coloured stars; heat set frise yarn; dim.: 3 x 4 m



**Street
DL0094**

- dim.: 3 x 4 m



**Ocean
DL0085**

- dim.: 4 x 5 m



**Circus
DL0104**

- dim.: 3 x 4 m



**Butterflies
DL0115**

- dim.: 4 x 5 m

POLYAMIDE WITH PATTERN

Carpets make the interiors cosy and comfortable. The presented carpets, which complete the Fantasy collection, in addition to aesthetic values, also provide space for physical and mental activities. Themed prints can inspire lots of fun games as well as stimulate curiosity and encourage interaction. The material from which they were made ensures the durability of the product.

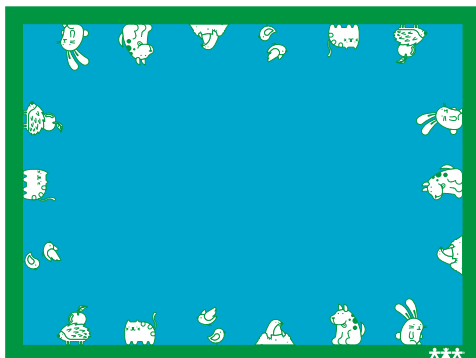

**Carpet Minty
HK0009**

- dim.: 3 x 4 m



**Labyrinth
HK0005**

- dim.: 3 x 4 m



**Snakes with ladders
HK0001**

- dim.: 2 x 3 m

HEAT SET FRISE



**Jungle
DL0500**

A carpet made from a double frise polypropylene yarn. These carpets are soft, antiallergic, anti-static, fade and wear resistant, easy to clean and with a non-slip bottom.

- dim.: 4 x 5 m
- heat set frise carpet

**Emotions. Round carpet
NS1106**

A round carpet with images of faces featuring emotions which helps develop social skills.

- ø 2 m;
- material: loop boucle;
- easy-to-clean non-slip latex bottom, overlock finishing



**Numbers. Round carpet
MU0006**

Round polyamide carpet covered with latex on the underside. The print of numbers on colourful backgrounds proves useful in learning to count or during games.

- ø 2 m



**Ladybird
HK0006**

- ø 2 m

SOFT MATS

A nice to touch mat with child-friendly prints. It owes its softness to polyurethane foam filling and polyester microfleece. The underside has non-slip properties which ensure safety. The mat isolates from the cold surfaces and provides space for different carpet activities in the nursery or kindergarten. It does not pill, and the upkeep is easy.



Town
DC1921

• dim.: 130 x 180 cm



Castle
DC1918

• dim.: 130 x 180 cm



Airport
DC1929

• dim.: 130 x 180 cm



Farm
DC1901

• dim.: 130 x 180 cm



Castle with a maze
DC1602

• dim.: 130 x 180 cm



Island
DC1603

• dim.: 130 x 180 cm



130 cm

130 cm



180 cm

n Lion
DC1926

• dim.: 130 x 180 cm



n Bear
DC1810

• dim.: 130 x 180 cm



ø 130 cm

n Round Bear
DC1930

• ø 130 cm



ø 130 cm

n Round landscape
DC1917

• ø 130 cm

130 cm



130 cm

n Colourful owls
DC1803

• dim.: 130 x 130 cm