



i n t e r n a t i o n a l

2023

**JUEGOS DE  
ACTIVIDAD**

**nowa szkoła**

# REHABILITATION & ACTIVITY PLAY

## REHAB SOFTPLAY BLOCKS

### SHAPES



Soft play elements ideal for gymnastics, active play as well as rehabilitation. We use high resilience foam in mattresses, seats, gym or play corners, hideouts, or therapy aids. Thanks to its plasticity, high resilience, and lightness, the products are easy to carry, safe and exceptionally functional while the phthalate-free PVC fabric resistant to abrasion makes the maintenance worry-free.

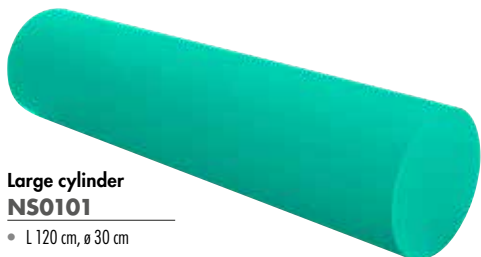

**Large cylinder  
NS0101**

- L 120 cm, ø 30 cm



**Mini high-density cylinder  
NS0145**

- L 60 cm, ø 15 cm
- made of higher-density foam



**Cylinder maxi  
NS0105**

- L 60 cm, ø 60 cm



**Small cylinder  
NS0228**

- L 60 cm, ø 10 cm



**Mini cylinder  
NS0229**

- L 60 cm, ø 15 cm



**Large cylinder  
NS0230**

- L 60 cm, ø 20 cm



**Medium cylinder  
NS0455**

- L 90 cm, ø 30 cm



**Short cylinder  
NS0456**

- L 30 cm, ø 30 cm

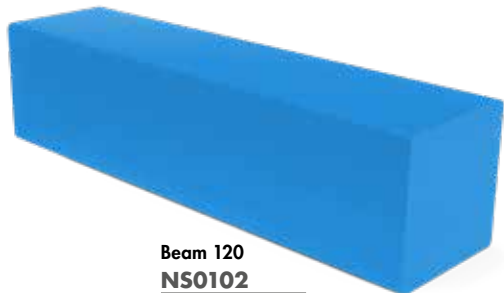

**Beam 120**  
**NS0102**

- 120 x 30 x 30 cm

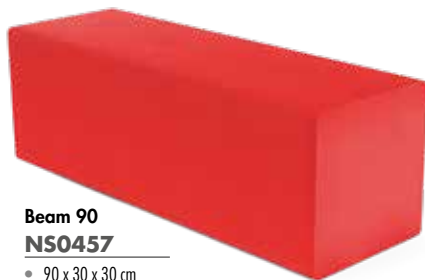

**Beam 90**  
**NS0457**

- 90 x 30 x 30 cm

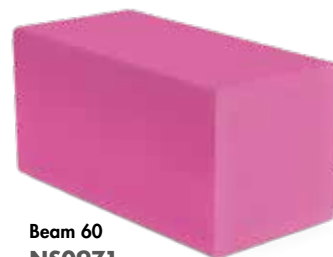

**Beam 60**  
**NS0971**

- 60 x 30 x 30 cm

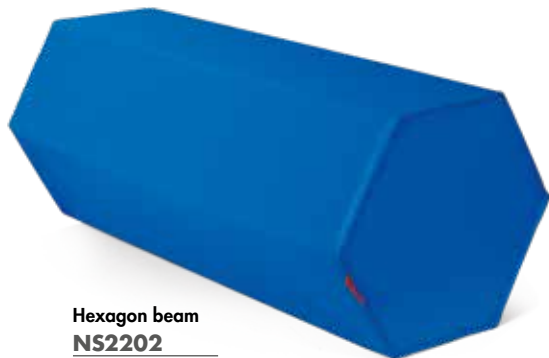

**Hexagon beam**  
**NS2202**

- 100 x 40 x 40 cm

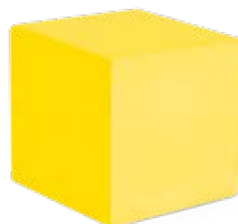

**Cube**  
**NS0458**

- 30 x 30 x 30 cm



**Mini beam**  
**NS0231**

- 60 x 20 x 20 cm



**Base with a rectangle**  
**NS0100**

- 60 x 60 x 30 cm



**Base with a semicircle**  
**NS0142**

- 60 x 60 x 30 cm



**Base with a triangle**  
**NS0143**

- 60 x 60 x 30 cm

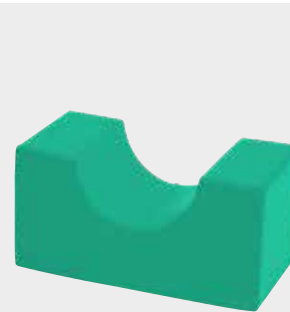

**Small base**  
**NS0970**

- 60 x 30 x 30 cm



**Large tyre**  
**NS0968**

- ø 120 cm (inside 60 cm)

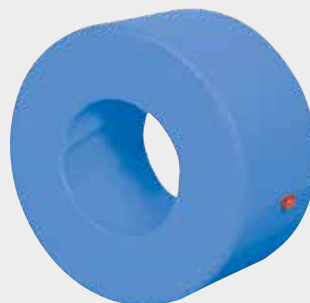

**Tyre**  
**NS0106**

- 60 x 30 x 30 cm

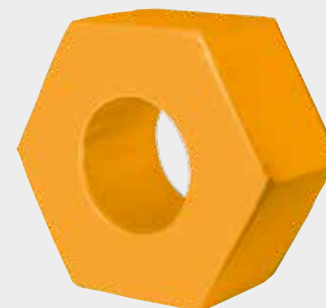

**Nut**  
**NS2153**

- ø 60 cm (inside 30 cm), 30 cm thick



**Bridge**  
**NS0103**

- 120 x 60 x 30 cm



**Arch**  
**NS0104**

- 120 x 60 x 30 cm



**Semicircle**  
**NS0109**

- 120 x 60 x 30 cm

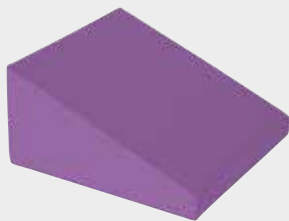

**Small wedge**  
**NS0969**

- 60 x 60 x 30 cm

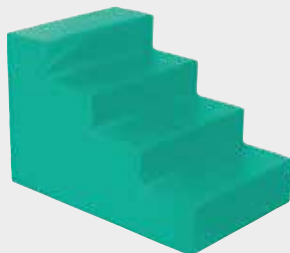

**Stairs**  
**NS0110**

- 90 x 60 x 60 cm



**Ramp**  
**NS0108**

- 90 x 60 x 60 cm



**Stairs with rounded steps**  
**NS2225**

- 90 x 60 x 60 cm

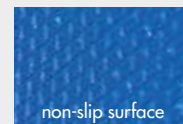

**Wide half cylinder**  
**NS2275**

- 60 x 30 x 20 cm;
- material: polyurethane foam, PVC fabric;
- colour: blue



**Large Wedge**  
**NS2278**

- 40 x 30 x 10 cm;
- material: polyurethane foam, PVC fabric;
- colour: grey



**Small Wedge**  
**NS2277**

- 20 x 20 x 20 cm;
- material: polyurethane foam, PVC fabric;
- colour: blue



**Half cylinder**  
**NS2276**

- 60 x 20 x 10 cm;
- material: polyurethane foam, PVC fabric;
- colour: grey

# BALANCE



velcro  
included



## Soft play hills NS3164

Two foam therapy hills in different forms. They help children develop their kinaesthetic sense as well as the awareness of the position of their body. Additionally, by walking on an uneven surface children improve the sense of balance. Thanks to this activity, a specialist

can observe little patients and choose the best kind of therapy for them. Velcro fastening ensures stability and prevents the aids from sliding. The case is made of an easy-to-clean PVC fabric in marine or blue colour. It is filled with polyurethane foam with increased density.

- 2 pcs;
- dim.: 195 x 48 cm;
- age: 1+





#### Wave sensory path NS3144

Two therapeutic foam hills which promote the development of the kinaesthetic sense and hence the perception of their own bodies. By walking on a soft but uneven surface, they also improve their balance. Additionally, the activity on the foam hills gives specialists a chance to observe the movements of little patients and, as a result, choose the right type of therapy.

Children can walk or crawl on the hills. Velcro fastening ensures stability and prevents the aids from sliding. The stability of the aid is ensured by hook and loop fasteners on the longer side. Covers are made of easy to clean PVC fabric in green and orange colours.

- 2 pcs;
- dim.: 195 x 48 cm; filling:
- high resilience polyurethane foam;
- age: 1+

4 shapes can be joined together, making a huge obstacle course



## TRACKS FOR TODDLERS



Foam shapes designed especially for toddlers who want to engage in more active playtime. With the foam shapes, it is possible to create safe and varied obstacle courses. They provide space for playtime or rehabilitation exercises for children in need of special care, or additional sensory stimulation. In our offer, you can find 4,5 and 9 module proposals in a set. All foam shapes are made of phthalate-free PVC fabric which is easy to clean. They are filled with polyurethane foam with increased density. It ensures comfort and durability. The non-slip bottom of the foam elements guarantees safety during exercise and play.



### Rehab tracks for toddlers. Set of 9 NS3420

- the set contains 9 elements;
- polyurethane foam; grey non-slip fabric; material: PVC fabric



Wedge

- dim.: 60 x 39 x 20 cm

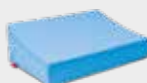

Wave ramp

- dim.: 60 x 39 x 20 cm



Wave

- dim.: 60 x 39 x 5 cm



Hill

- dim.: 60 x 39 x 10 cm

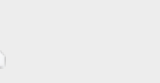

Half wave

- dim.: 60 x 39 x 9,5 cm



Flower

- dim.: 60 x 39 x 14 cm



Hillock

- dim.: 60 x 39 x 10 cm

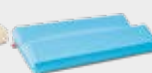

Houses

- dim.: 60 x 39 x 12 cm



Mattress

- dim.: 60 x 39 x 5 cm



### Rehab tracks for toddlers. Set of 5 NS3418

- dim.: width: 60 cm; depth: 39-40 cm; height: 5-20 cm;
- cover: phthalate-free PVC fabric resistant to abrasion; filling: high resilience polyurethane foam; 5 elements



Hillock

- dim.: 60 x 39 x 10 cm

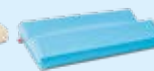

Houses

- dim.: 60 x 39 x 12 cm

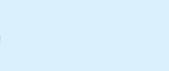

Half wave

- dim.: 60 x 39 x 9,5 cm



Mattress

- dim.: 60 x 39 x 5 cm



Hill

- dim.: 60 x 39 x 10 cm

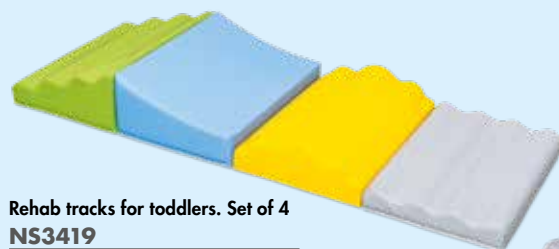

### Rehab tracks for toddlers. Set of 4 NS3419

- the set contains 4 elements;
- polyurethane foam



Wedge

- dim.: 60 x 39 x 20 cm

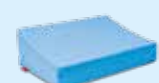

Wave ramp

- dim.: 60 x 39 x 20 cm



Wave

- dim.: 60 x 39 x 5 cm



Flower

- dim.: 60 x 39 x 14 cm





**Balance beam**  
**NS2185**

- non-slip bottom;
- size: 120 x 50 x 13,5 cm;

**Craddle**  
**NS1545**

- size: 146 x 73 cm, thickness: 11 cm;
- age: 3+;



**Cap with stem**  
**NS0150**

- cap ø 120;
- stem ø 30, H 120 cm



**Rehabilitation chair**  
**NS0595**

- an armchair, dim.: 110 x 70 x 36 cm;
- the cover is made of non-slip pvc fabric in beige and marine colour;
- filling: polyurethane foam;
- weight: 6,2 kg;
- additional information: the set includes an armchair and a roller



**Rainbow tunnel**

**NS2182**

4 elements:

- size: 100 x 60 x 70 cm, 80 x 60 x 60 cm, 60 x 60 x 50 cm, 40 x 60 x 40 cm



**Horseshoe**

**NS2184**

- size: 80 x 60 x 60 cm



**Frog**

**NS0687**

- size.: 190 x 50 x 36 cm



**Weight pouches**

**NS2224**

A multi-colour set of 6 pouches for various balancing and strengthening exercises. 3 pairs of different size and weight covered with durable,

easy-to-clean PVC fabric and filled with heavy granulate.

- dark green 1,5 kg x 2;
- green 1 kg x 2;
- light green 0,5 kg x 2

# SOFT ROCKERS

## FRUITS



Soft rockers attract attention with their intensive colours and forms. When turned on its side, a rocker becomes a seat or a small play table.

- foam padding; cover: PVC fabric



### Banana

#### NS2209

- size: 85 x 26 x 55,5 cm
- seat height 30 cm



### Orange

#### NS2208

- size: 70 x 26 x 52 cm; seat height 30 cm



### Kiwi

#### NS2210

- size: 70 x 26 x 52 cm; seat height 30 cm



### Watermelon

#### NS2211

- size: 70 x 26 x 52 cm; seat height 30 cm

## VEHICLES



**Car**  
**NS2188**

- size: 87 x 26 x 48, seat height 26 cm



**Motorcycle**  
**NS2190**

- size: 90 x 26 x 47 cm, seat height 26 cm



**Pony**  
**NS2189**

- size: 80 x 26 x 64 cm, seat height 26 cm;
- anti-slip

## ANIMALS



**Rabbit rocker**  
**NS2234**

- dim.: 69 x 62 x 26 cm;
- material: polyurethane foam, PVC fabric;
- colour: grey, white;
- anti-slip

Rocker in the shape of a lovable pet which guarantees a lot of fun and stimulation for the vestibular system, ensuring child's proper development. The stable construction and wide base ensure



**Duckling rocker**  
**NS2235**

- dim.: 67 x 59 x 26 cm;
- material: polyurethane foam, PVC fabric;
- colour: orange, yellow;
- anti-slip

safety while in use. The high density of polyurethane foam guarantees the durability of the product. The cover is made of phthalates-free PVC fabric which is easy to clean and disinfect.



**Husky rocker**  
**NS3410**

- dim.: 24 x 78 x 59 cm;
- material: phthalate-free PVC fabric in grey colour, dog silhouette print;
- filling: polyurethane foam;
- anti-slip



**Whale rocker**  
**NS3411**

- dim.: 96,6 x 24 x 46 cm;
- equipped with a handle;
- material: phthalate-free PVC fabric in blue – white – black colour;
- filling: polyurethane foam



**Swan rocker**  
**NS3412**

- dim.: 75 x 24 x 68,8 cm;
- material: phthalate-free PVC fabric in white – orange – black colour;
- filling: polyurethane foam;
- anti-slip



### Giraffe rocker NS3413

- dim.: 80 x 24 x 79,5 cm;
- the cover is made of PVC fabric in brown colour;
- it is filled with polyurethane foam;
- weight: 3 kg; two-sided print in the form of a giraffe
- anti-slip



Rocker in the shape of an adorable pet provides lots of fun and at the same time stimulates the vestibular system, promoting healthy child development. The stable structure and wide base of the rocker ensure safety during use. The high density of polyurethane foam guarantees the durability of the product. The cover is made of phthalate-free PVC fabric which is easy to clean and disinfect. Some models are equipped with a handle which makes moving them from one place to another much easier.



### Zebra rocker NS3414

- dim.: 84,5 x 24 x 61 cm;
- the cover is made of PVC fabric in charcoal grey colour; it is filled with polyurethane foam;
- weight: 2,2 kg;
- two-sided print in the form of a zebra;
- anti-slip



# MATTRESSES



## SMALL



**Mattress Milus  
NS0599**

- wipe-clean, anti-slide bottom;
- 120 x 60 x 10 cm

## MEDIUM



**Short running track  
NS0170**

- 160 x 60 x 7 cm

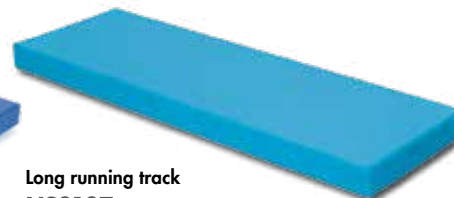

**Long running track  
NS0107**

- 180 x 60 x 10 cm

## REGULAR



**Mattress  
PS2128**

- 200 x 80 x 10 cm

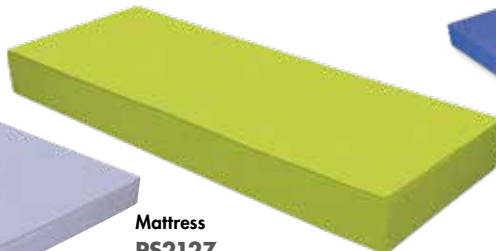

**Mattress  
PS2127**

- 200 x 80 x 20 cm



**Rehabilitation  
mattress  
NS0144**

- 200 x 80 x 10 cm;
- made of higher-density foam

# GYMNASTIC MATTRESS WITH REINFORCED CORNERS AND HANDLES

## MAXI

Thick and wide mattress equipped with additionally reinforced corners. Covered with easy to clean and disinfect phthalate-free PVC fabric. The mattress is filled with flexible polyurethane rebound foam with increased density.

- 200 x 150 x 25 cm; material: PVC fabric, polyurethane foam

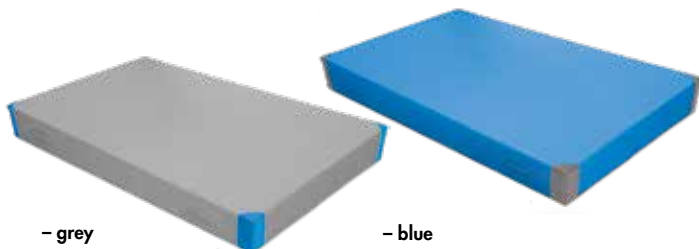

### - grey NS2283

- reinforced corners in blue;
- colour: light grey;
- with handles



comfortable handles  
NS 2187  
NS 2186

### - blue NS2287

- reinforced corners in grey;
- colour: blue;
- with handles



reinforced corners  
NS 2187  
NS 2186  
NS 2159

## SCHOOL



### NS2159

- 200 x 120 x 6 cm
- without handles

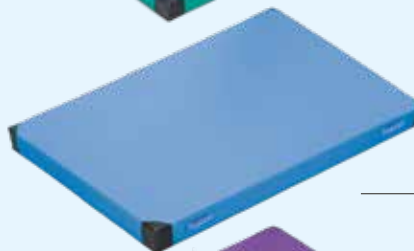

### NS2186

- 200 x 120 x 10 cm
- with handles

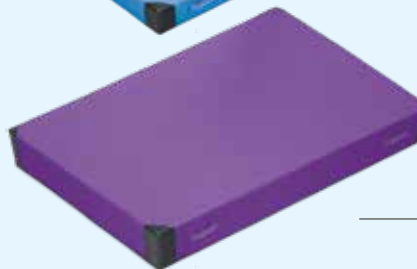

### NS2187

- 200 x 120 x 20 cm
- with handles





## MAXI ANTI-SLIP



## ANTI-SLIP GYMNASTIC MATTRESS WITH HANDLES



- dim.: 200 x 120 x 8 cm; equipped with handles;
- material: PVC fabric, polyurethane foam

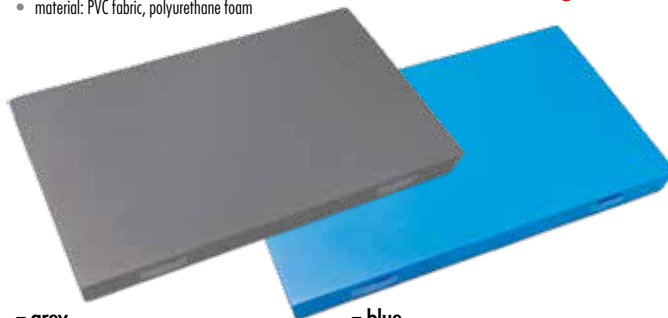

– grey  
**NS2282**

- colour: grey

– blue  
**NS2281**

- colour: blue

## MAXI WITH PATTERN



**Kitty Maxi mattress**  
**NS2244**

- dim.: 185 x 140 x 20 cm;
- material: phthalate-free PVC fabric, colour: white - grey;
- filling: polyurethane foam with increased density



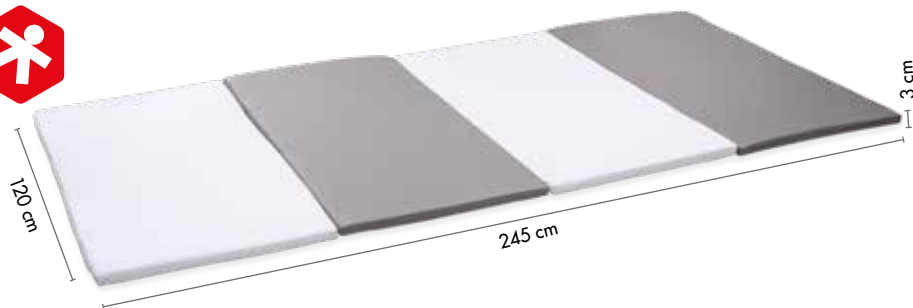

## FOLDING

### RECTANGULAR 4 SECTION

- 4-piece, folded; 120 x 62 x 12 cm
- when unfolded: 120 x 245 x 3 cm;
- 2 elem. in grey, 2 elem. in other colours;
- material: phthalate-free PVC fabric, polyurethane foam with increased density



- blue – grey  
**NS2279**

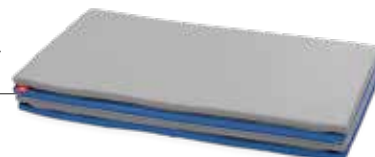

- white – grey  
**NS2280**



- lime – grey  
**NS3184**



- grey – marine  
**NS3185**



- yellow – grey  
**NS3186**



- pink – grey  
**NS3187**



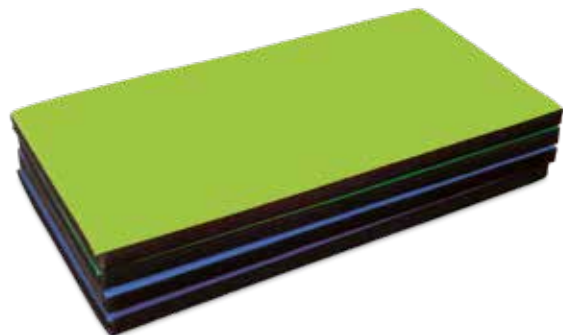

**Velcroed mattresses  
NS2147**

- 4 pcs;
- dim.: 114 x 60 x 5 cm

large safe area  
for exercise

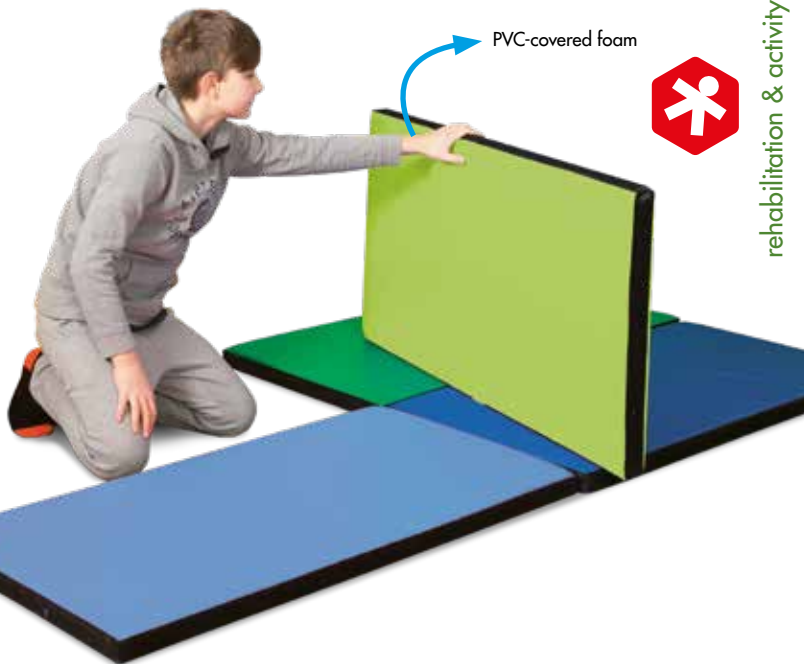
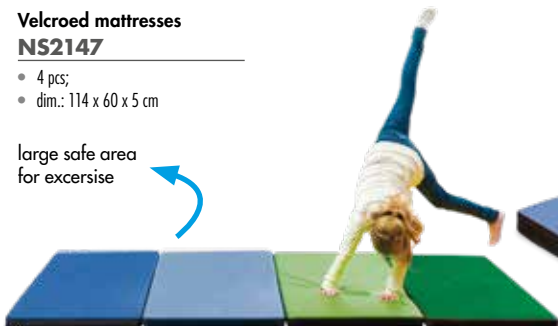

**RECTANGULAR 3 SECTION**

**3 SECTION FOLDING ACTIVITY MAT**

- dim.: 180 x 60 x 5 cm when unfolded;
- material: PVC



- Red  
**PS2160**



- Blue  
**PS2160NP**



- Pink  
**PS2160RP**

## WALL 2 SECTION



### Mattresses NS0554

2 connectable mattresses for exercise or play, that can be joined with an aluminium tube threaded through loops. With one mattress standing upright at the wall, the child is protected from accidental injury.

- dim.: 150 x 100 x 5 cm (single mattress);
- dim.: 150 x 200 x 5 cm when joined, set includes tubes and a hook (to fix on the wall)



## ANIMAL 2 SECTION

- dim. when unfolded: 121 x 80 x 5 cm;
- dim. when folded: 60 x 80 x 10 cm;
- age: 6 months+



**Panda**  
**NS2113**

**Mole**  
**NS2114**



## SQUARE 4 SECTION

4-part mattresses which when leaned against the wall may serve as a seat. Unfolded on the floor, they will form a play (or exercise) area.

- folded 50 x 50 x 20 cm;
- unfolded 100 x 100 x 5 cm;
- material: PVC



- black & white  
**NS2152**



- colour  
**NS2151**



## LARGE MATS

- foam with PVC cover

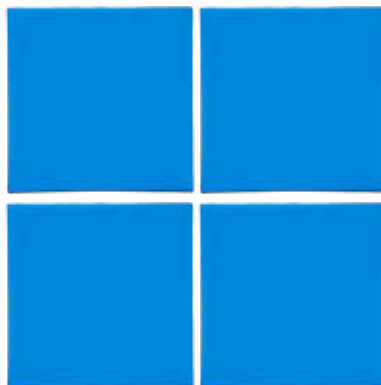

- Blue mat  
**NS2177**

- 4 panels dim.: 122 x 123 x 5 cm;
- dim. when folded: 244 x 246 x 5 cm

- Grey maxi mat  
**NS2219**

- 2 pcs;
- dim.: 196 x 193 x 3 cm; colour: grey



- Grey mat  
**NS1888**

- dim.: 140 x 140 x 2 cm

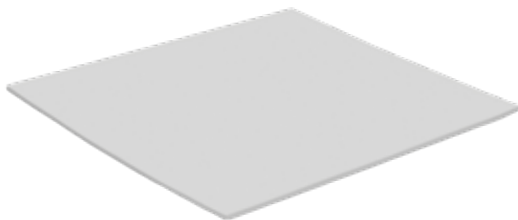

- Green mat  
**NS8000**

A set of mats which when velcroed together create a large free play space

- 6 pcs; single mat dim.: 170 x 212,5 x 3 cm;
- colour: green;
- velcro fastening



## CORNER

A corner mattress made of PVC-covered foam.  
Anti-slip bottom to prevent accidental slides during play.

- dim.: 100 x 100 x 10 cm

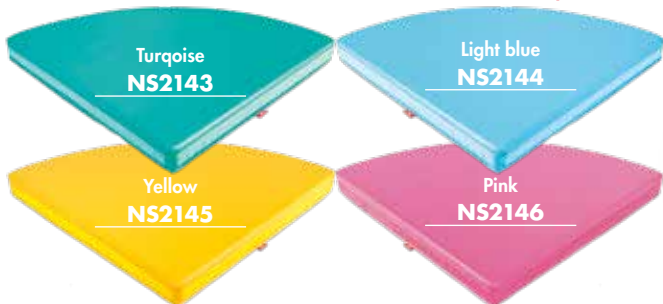

two acrylic mirrors



colorful and fun appliques



3 elements



### Day & Night Corner NS2149

A folding corner for toddlers,  
an ideal place for safe play.

- floor mattress 115 x 115 x 10 cm;
- 2 walls 115 x 115 x 5 cm

## SQUARE

- dim.: 100 x 100 x 5 cm

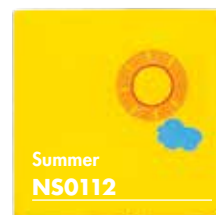

## SENSORY MATS



### Texture Track NS2150

A set of sensory foam shapes for children to arrange.

- made of PVC covered foam;
- 10 squares: 40 x 40 x 3,5 cm;
- 4 quarters: 40 x 40 x 3,5 cm;
- 1 circle: ø 40 cm



### Round mattress with pockets & mirrors NS2199

A very comfortable soft mattress for toddlers to roll and crawl freely. The added mirrors stimulate sight, help develop self-awareness and interpersonal social skills. The small pockets will hold illustrations or suggested

worksheets for stimulating curiosity and the will to explore. The mattress is padded with soft foam and covered with coloured PVC fabric.

- ø 137 cm, T 3 cm;
- 1 round mirror ø 27 cm;
- 3 square mirrors 17 x 17 cm;
- 3 pockets 12 x 12 cm

3 pockets  
suitable for  
NS worksheets

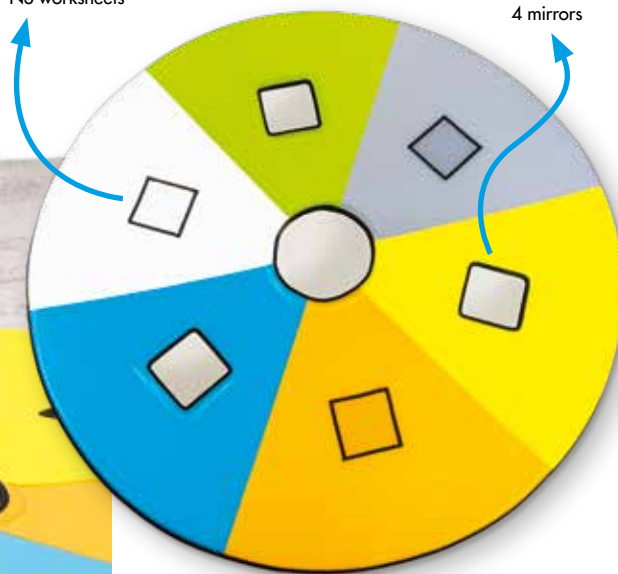

## MATS

### Gymnastic mat NS0553

A thin foldaway mat for exercises on hard ground.

- dim.: 150 x 60 x 2 cm



### Sensory mat NS0949

Consists of 6 squares with foam rubber padding and 6 pockets for various materials (cones, stones, peas, conkers, sticks, small balls).

- dim.: 60 x 120 cm



## GYMNASTIC MAT

- 180 x 0,8 x 59 cm; material: EVA foam; age: 3+



- Blue  
ST2001

- Green  
ST2002



## MAXI GYMNASTIC MAT

- 200 x 0,8 x 80 cm; material: EVA foam; age: 3+

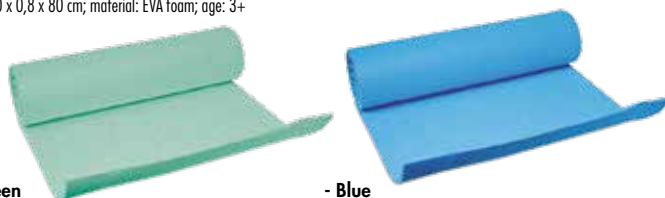

- Green  
ST2003

- Blue  
ST2004

## FLOOR MAT PUZZLE

Foam jigsaw pieces to form a large interlocking floor mat for play areas.

- 1 pcs; size 102,6 x 102,6 x 2 cm

- Blue  
ST2100

- Green  
ST2101







### NS1120

- V-cut base x 2 (NS 0143)
- Beam 120 x 1 (NS 0102)

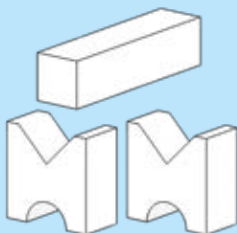

## SETS

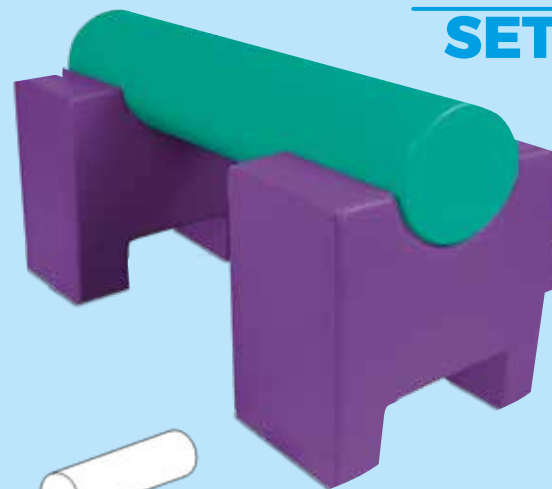

### NS1130

- U-cut base x 2 (NS 0142)
- Large cylinder x 1 (NS 0101)

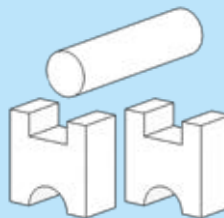

### NS1160

- Small tyre x 2 (NS 0106)
- Large log x 1 (NS 0101)
- Mat 7 cm x 1 (NS 0170)

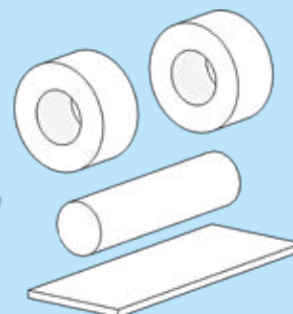

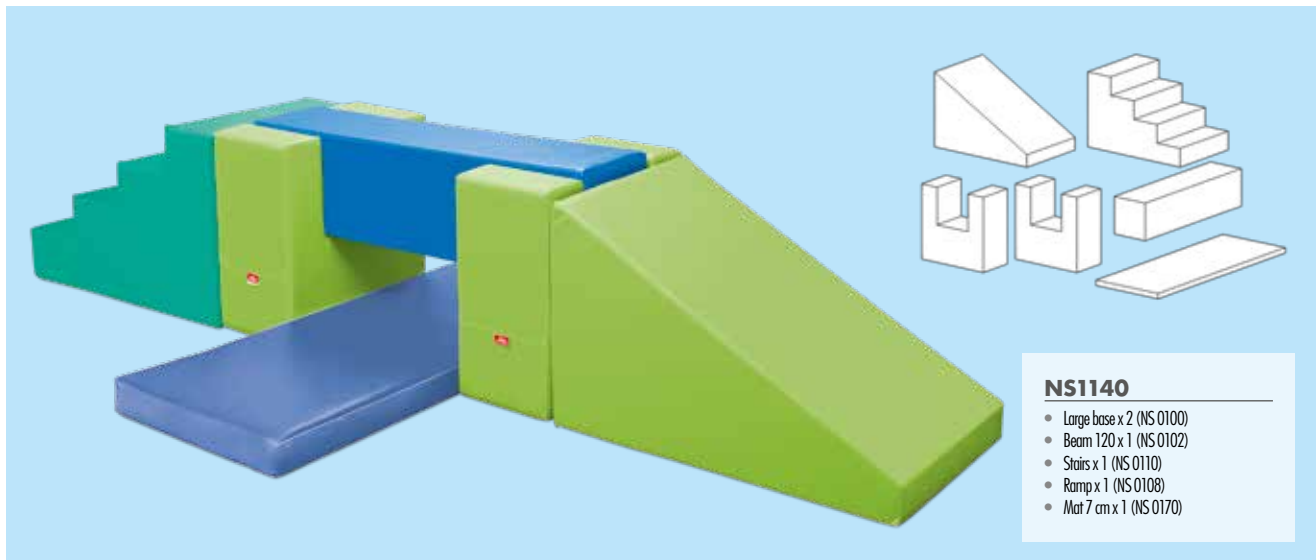

- NS1140**
- Large base x 2 (NS 0100)
  - Beam 120 x 1 (NS 0102)
  - Stairs x 1 (NS 0110)
  - Ramp x 1 (NS 0108)
  - Mat 7 cm x 1 (NS 0170)

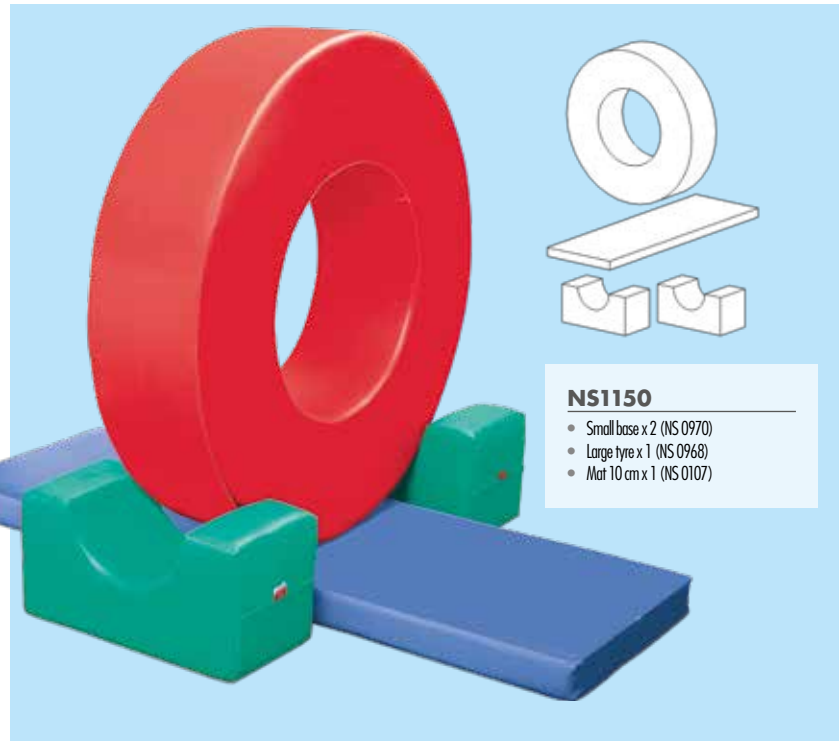

- NS1150**
- Small base x 2 (NS 0970)
  - Large tyre x 1 (NS 0968)
  - Mat 10 cm x 1 (NS 0107)

# ULTRA BLOCKS

## NS3149

A set of giant softplay blocks coated with durable PVC fabric. The various sizes provide numerous possibilities for building castles and hiding places. They can also be used in rehabilitation exercises.

- 40 pcs;
- dim. of the smallest piece: 40 x 20 x 20 cm;
- dim. of the biggest piece: 120 x 20 x 20 cm

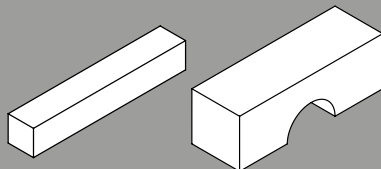

4x  
120 x 20 x 20 cm

1x  
120 x 40 x 40 cm

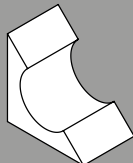

4x  
60 x 60 x 40 cm

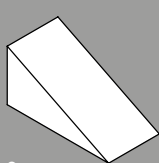

2x  
89,4 x 40 x 35,7 cm

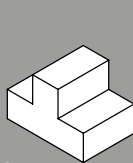

2x  
60 x 40 x 40 cm

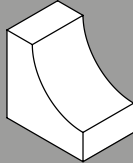

2x  
60 x 60 x 40 cm



2x  
40 x 40 x 20 cm

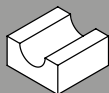

2x  
40 x 40 x 20 cm

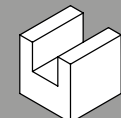

1x  
40 x 40 x 40 cm

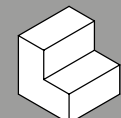

2x  
40 x 40 x 40 cm



2x  
40 x 20 x 20 cm



1x  
ø 20 x 40 cm



4x  
40 x 20 x 20 cm

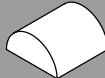

1x  
40 x 40 x 20 cm

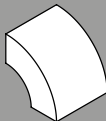

2x  
56,6 x 40 x 25,8 cm

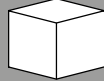

4x  
40 x 40 x 40 cm

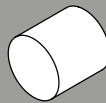

2x  
ø 40 x 40 cm

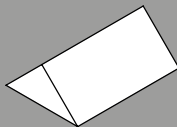

2x  
80 x 56,6 x 28,2 cm



40 elements



# HYPER BLOCKS

## NS0435

A set of giant softplay blocks coated with durable PVC fabric. The various sizes provide numerous possibilities for building castles and hiding places. They can also be used in rehabilitation exercises.

- smallest piece 20 x 20 x 20 cm;
- largest piece 120 x 40 x 40 cm

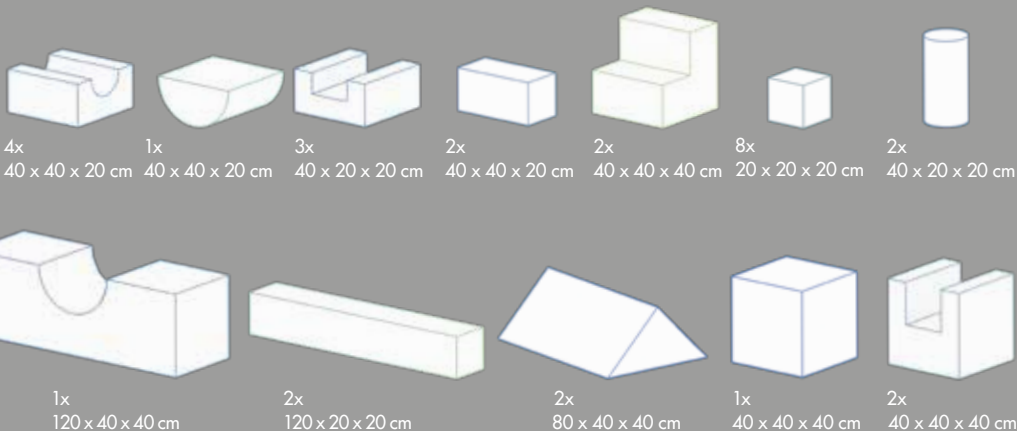

30 elements  
various sizes



# MEGA BLOCKS

## PS2105

A set of giant softplay blocks coated with durable PVC fabric. The various sizes provide numerous possibilities for building castles and hiding places. They can also be used in rehabilitation exercises.

- 8 elements – 90 x 30 cm;
- 10 elements – 30 x 30 cm;
- 1 element – ø 60 cm

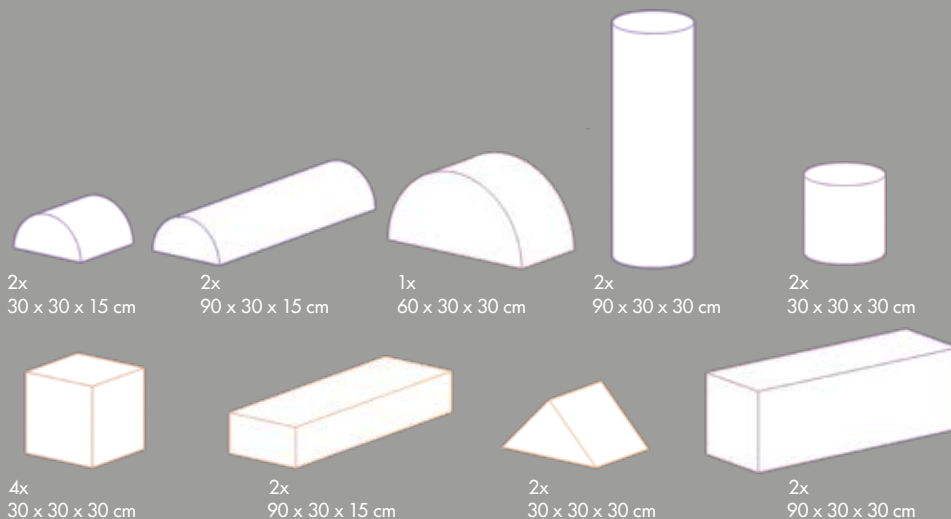

# FOAM CUBE

Motorical Activity Centre in just one box, suitable for the home and preschool/nursery use. (Patent No 8296881). This modular cube easily unfolds its 6 edges and transforms to sport mattress that combines various elements, such as balls pool, cylinders of different sizes, swings, stairs, slope, crawling tunnel and balance surface. designer Gili Litman Golan.

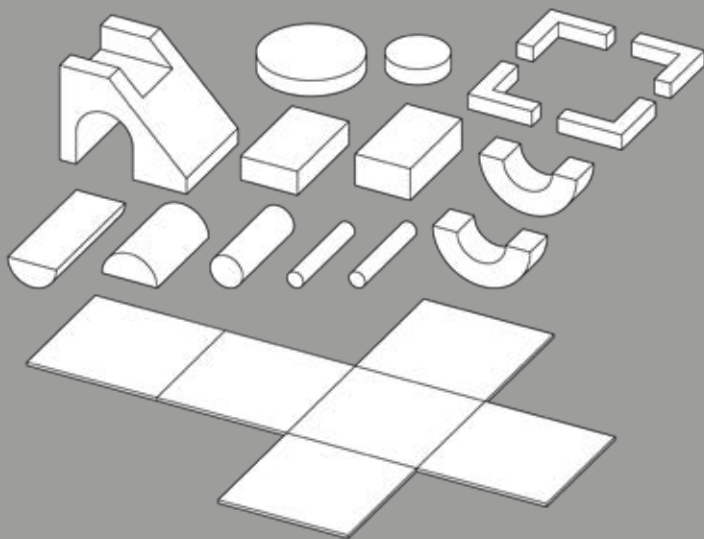

**Cube 80**  
**GB0080**

- cube – 17 parts; 80 x 80 cm;
- age group: 3m–3y

**Cube 100**  
**GB0100**

- cube – 16 parts; 100 x 100 cm;
- age group 3y–7y



# NOVAMUS

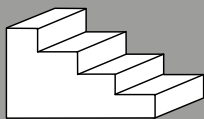

1x  
50 x 100 x 50 cm

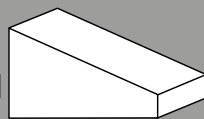

1x  
50 x 100 x 50 cm



1x  
ø 50 x 50 cm

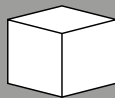

1x  
50 x 50 x 50 cm

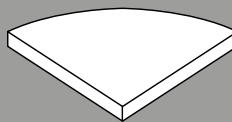

4x  
100 x 100 x 10 cm

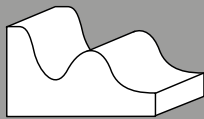

1x  
50 x 100 x 50 cm

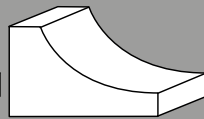

1x  
50 x 100 x 50 cm

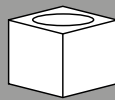

1x  
50 x 50 x 50 cm



## NS0125

11 elements for building assault courses.

- dim.: 250 x 250 x 150 cm



# NOVAMUS - FOAM REHAB SHAPES. SET 1

## NS0122

- 4 pcs: a wedge, a wave, stairs, a slide;
- dim.: 100 x 50 x 50 cm;
- cover: resistant to abrasion phthalate-free PVC fabric;
- non-slip underside made of textured PVC fabric;
- filling: high resilience polyurethane foam

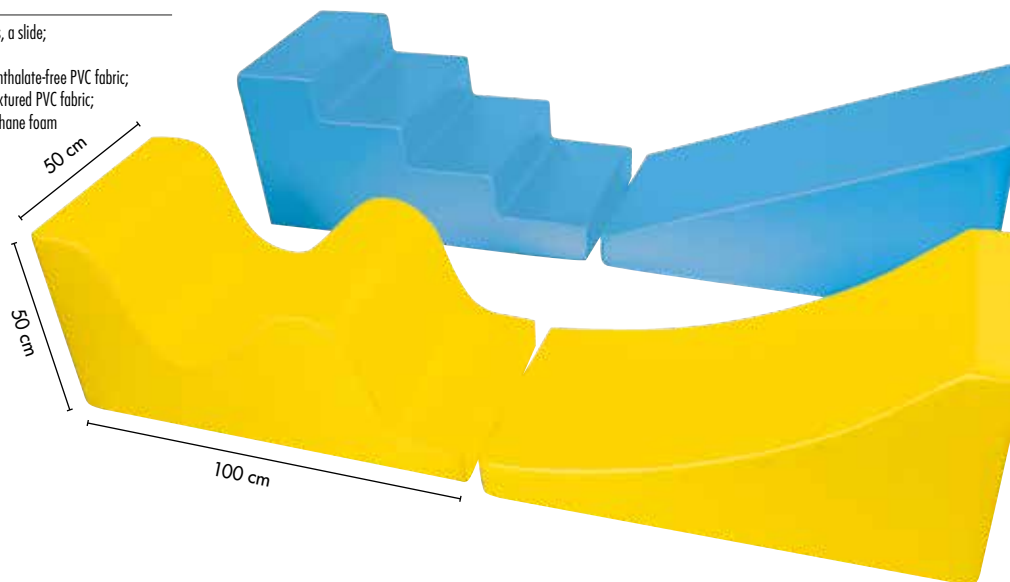

# NOVAMUS. SET 3



## NS0124

- 2 pcs;
- dim.: the tunnel: 50 x 50 x 50 cm and diam. of 40 cm;
- small roller, diam. of 40 cm;
- cover: phthalate-free PVC fabric resistant to abrasion;
- filling: high resilience polyurethane foam



1x  
ø 50 x 50 cm

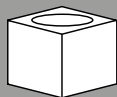

1x  
50 x 50 x 50 cm

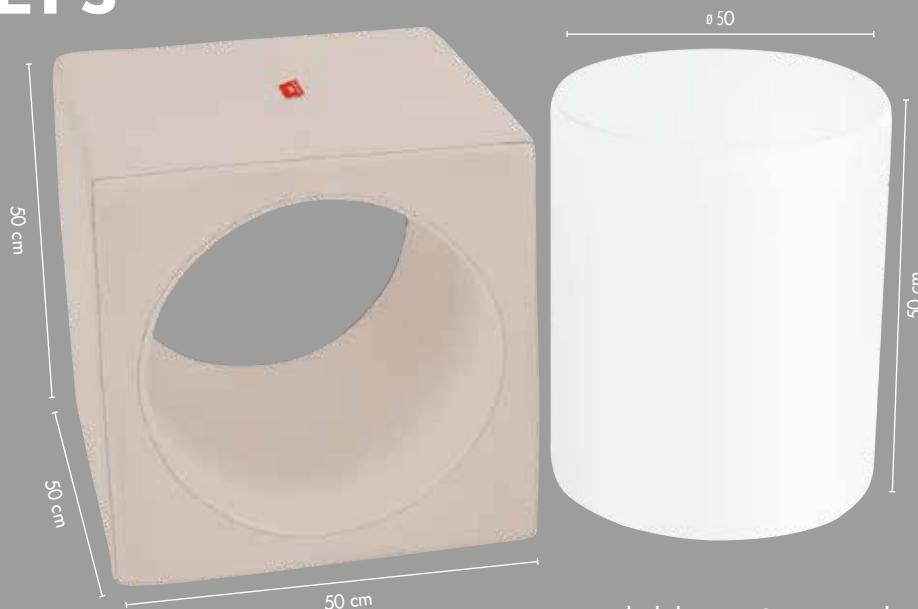



# BIG NOVAMUS

## NS0128

- 19 elements made of foam covered with PVC fabric;
- 284 x 284 x 60 cm;
- 100 cm in the highest point

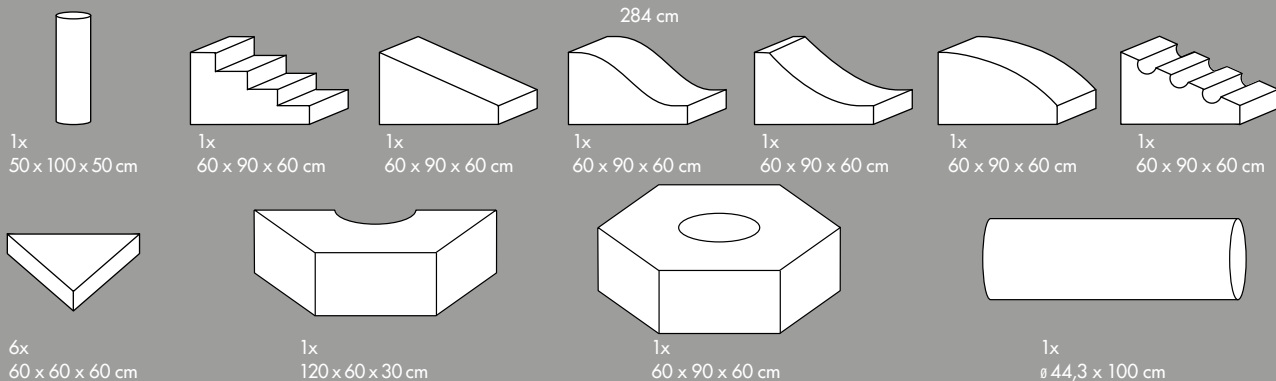
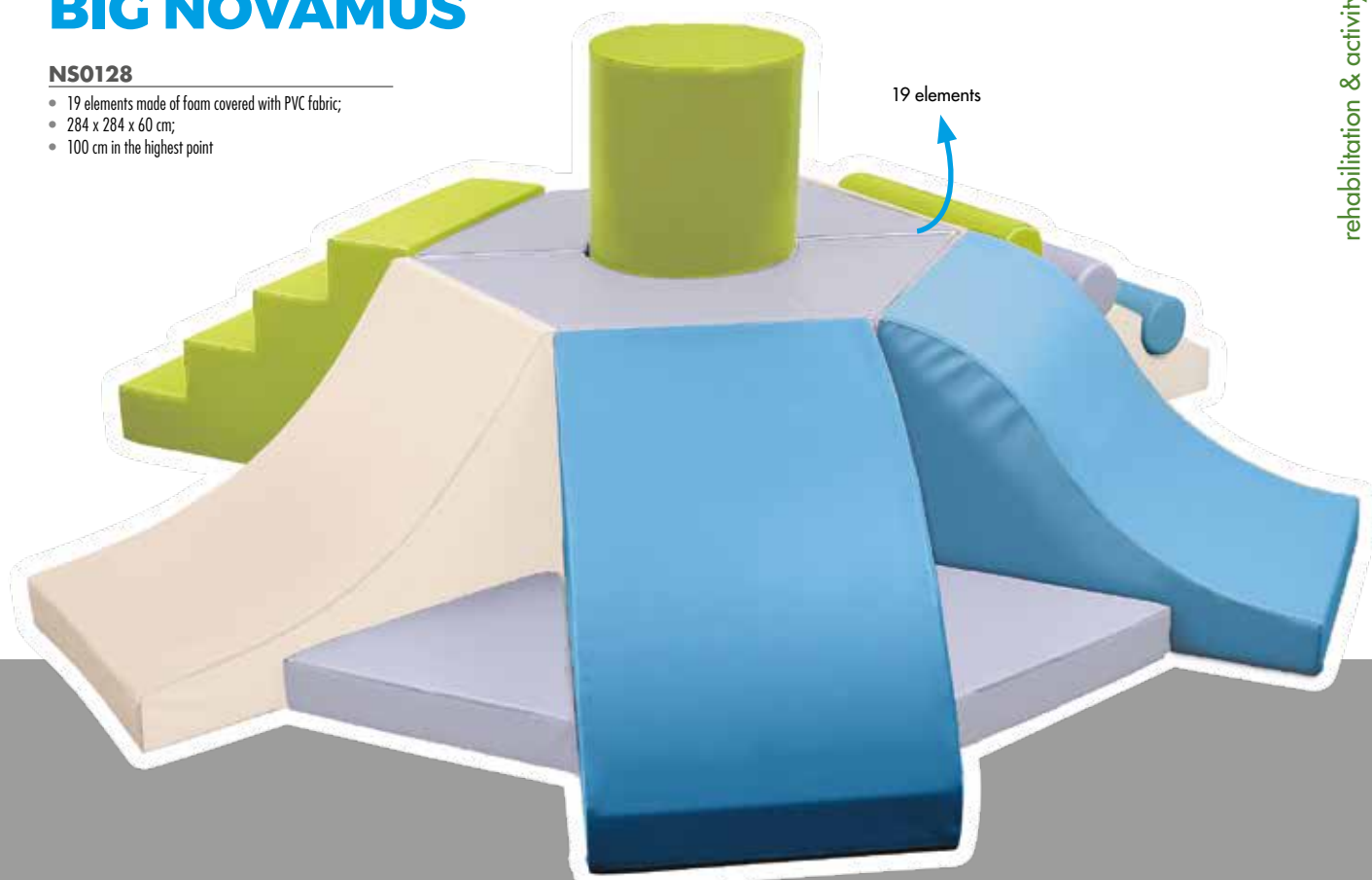

# LEO

## NS1221

The set of Leo foams is an interesting combination of various shapes providing many possibilities of physical activities supporting the development of motor skills for children. They can be also used in physical rehabilitation and during corrective gymnastics. Elements of the set were additionally equipped with textured mats and reflective foil to enhance sensory experiences. The set's components can create one big obstacle course and spatial constructions. All of the elements are made of polyurethane foam with increased density, resistant to deformation and providing comfortable use. The cover made of phthalate-free PVC fabric soft to touch and easy to clean.

- 9 pcs:  
stairs 80 x 40 x 40 cm,  
ramp 90 x 40 x 40 cm,  
2 pairs of rounded steps 80 x 40 x 40 cm,  
rectangular base 80x40 x 40 cm with textured mats with diameter: 25 cm,  
2 pairs of cubes 40 x 40 x 40 cm with a soft mirror, diameter: 30 cm,  
2 pairs of slides 40 x 40 x 40 cm;
- material: polyurethane foam, PVC fabric, reflective foil, non-slip fabric in blue, blue medical PVC fabric, grey fleece

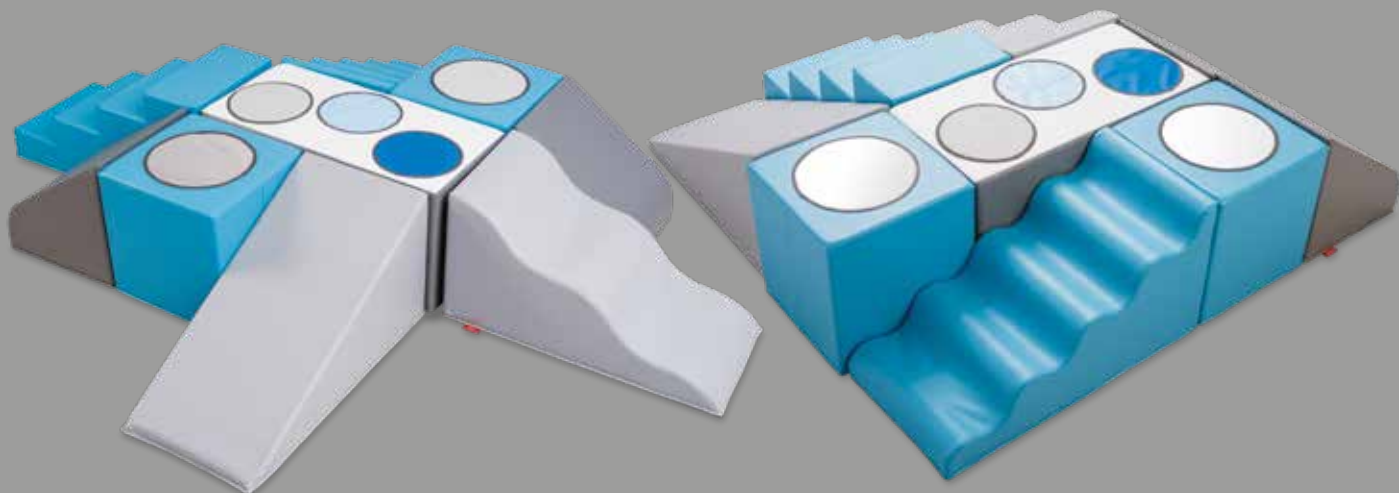

# KAYTEK

## NS0224

- 10 items made from foam covered with PVC fabrics;
- required surface: min. 4 m<sup>2</sup>



3 elements

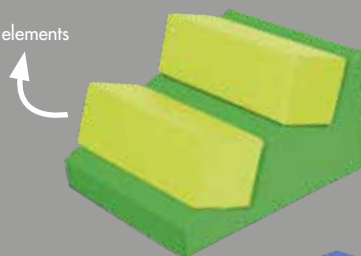

**Base with beams**  
**NS0227**

- base 60 x 70 x 40 cm;
- 2 beams 20 x 20 x 60 cm

**Hill**  
**NS0233**

- 60 x 70 x 43 cm

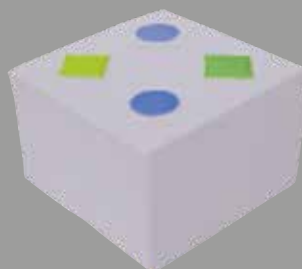
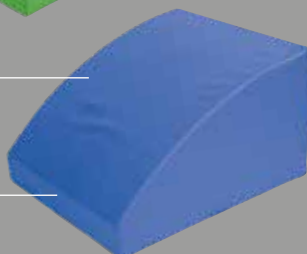

**Base with attractions**  
**NS0225**

- 60 x 60 x 40 cm

4 elements

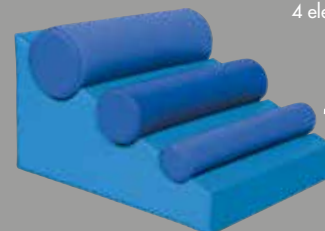

**Base with cylinders**  
**NS0226**

- 3 cylinders: ø 10, 15, 20 cm;
- base 60 x 70 x 40 cm



**Slide**  
**NS0232**

- dim.: 60 x 70 x 40 cm

# TODDLER'S SET WITH CYLINDERS

**NS2226**

The ramp has 2 bases and two cylinders. Can be used separately or as part of an obstacle course.

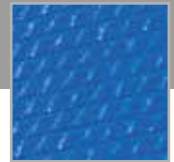
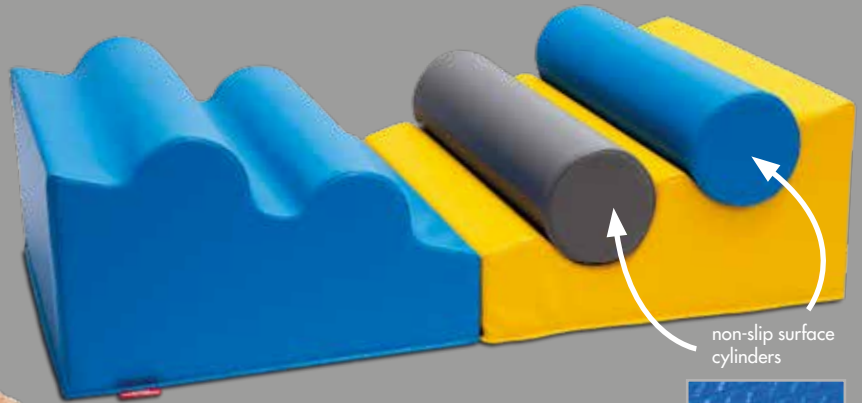
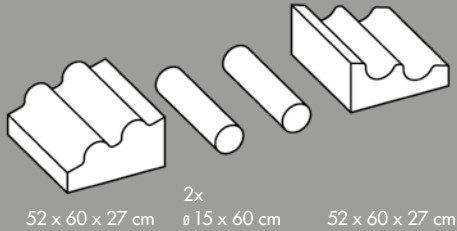

# TODDLERS' ACTIVITY CORNERS TRACK WITH SLIDE

## NS2198

Made of soft shapes joined with strong velcros, this corner guarantees long and safe play time in creches, nurseries and playrooms. It helps develop muscles, motor coordination and peer relations. It will also enrich motor rehabilitation rooms or sensory integration therapy rooms. For children's safety, all the elements are made of non-slip fabric.

velcro fastening

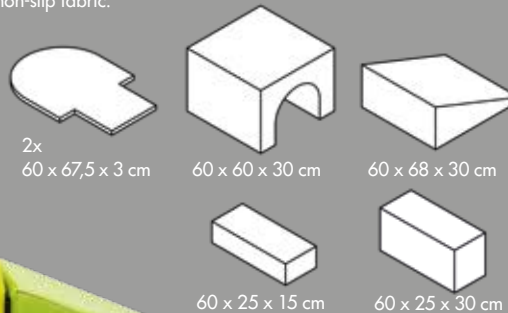

# TODDLER'S ACTIVITY CORNER WITH POOL

NS2197

The drypool made of elastic foam guarantees safe play. Each shape is covered with easy-to-clean fabric. The colours have been selected so as to encourage children to be active physically and to create various spatial configurations. The mattress, which is part of the set, serves as the bottom of the pool to be filled with coloured balls. For children's safety, all the elements are made of PVC fabric.

- balls sold separately



50 x 50 x 30 cm



30 x 50 x 30 cm



50 x 50 x 30 cm



85 x 65 x 3 cm



100 x 50 x 25 cm



100 x 80 x 15 cm

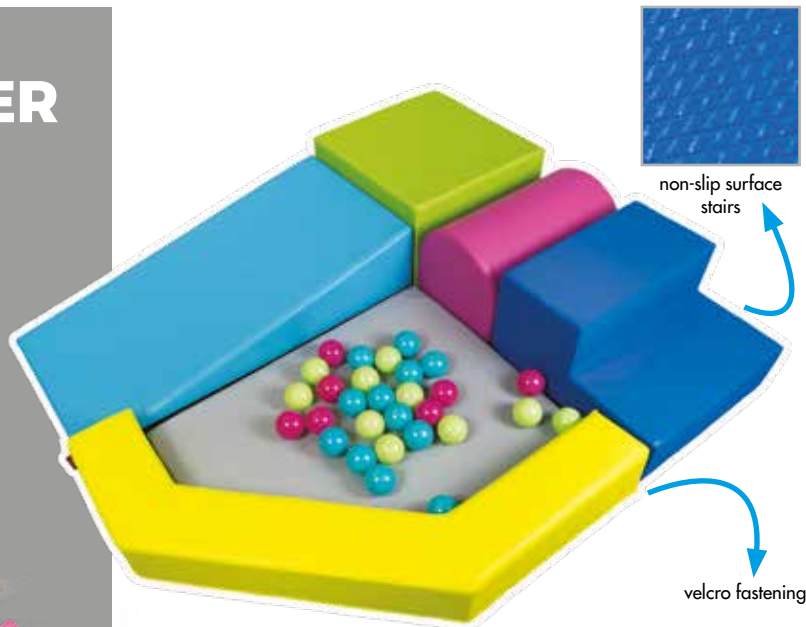

# SOFT PLAY SETS



2x  
30 x 30 x 30 cm



30 x 30 x 15 cm



2x  
∅ 30 x 30 cm

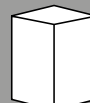

2x  
30 x 30 x 45 cm



60 x 30 x 30 cm

## Set 1 NS1994

- 120 x 75 x 30 cm;
- 10 elements

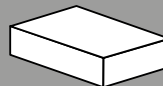

60 x 15 x 30 cm

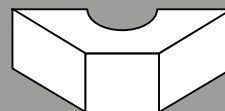

90 x 30 x 30 cm



2x  
30 x 30 x 30 cm



2x  
30 x 30 x 30 cm



60 x 30 x 30 cm



2x  
∅ 30 x 30 cm



2x  
∅ 30 x 60 cm

## Set 2 NS1995

- 150 x 90 x 30 cm;
- 11 elements

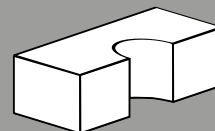

2x  
90 x 30 x 30 cm



2x  
30 x 30 x 30 cm

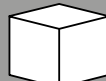

2x  
30 x 30 x 30 cm



30 x 30 x 15 cm

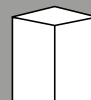

2x  
30 x 30 x 45 cm



2x  
∅ 30 x 60 cm

## Set 3 NS1996

- 120 x 90 x 30 cm;
- 10 elements

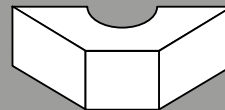

90 x 30 x 30 cm

**Mosaic  
NS1972**

- 9 pcs;
- set dim.: 140 x 140 x 15 cm;
- smallest pc dim.: 35 x 35 x 15 cm

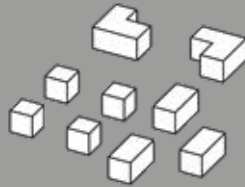

**Softplay cube  
PS2162**

- set dim.: 100 x 100 x 100 cm;
- 16 pcs

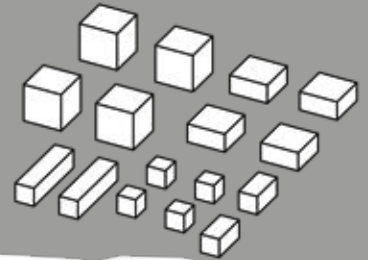

16 elements



**Softplay cube cover  
PS2163**

- for Softplay cube (PS2162);
- 1 pc







82 cm

**Foam tangram**
**NS2242**

The aim of the game is to arrange figures of people, animals, vehicles, houses and geometric figures using the elements of the set. Children learn how to fit elements together and create new shapes.

- 7 figures: 2 identical large right-angled triangles, 1 medium-sized right-angled triangle, 2 identical small right-angled triangles, 1 small square, 1 small parallelogram;
- made from foam covered with PVC fabrics;
- thickness 20 cm;
- available worksheets (sold separately)

**Tangram. Worksheets**
**NS2242W**

- 24 pcs; size 23 x 11 cm

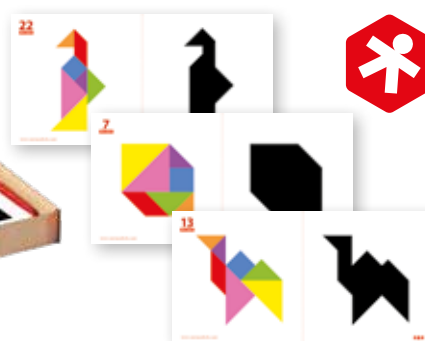
**Geometric figures**
**NS0567**

- a set of 4 figures, thickness 4 cm;
- triangle 36 x 36 x 31 cm;
- square 30 x 30 cm;
- rectangle 30 x 42 cm;
- circle ø 30 cm

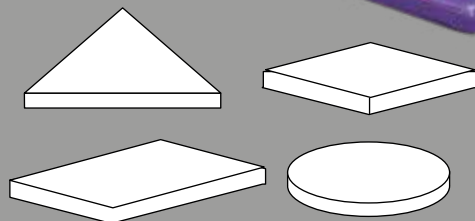
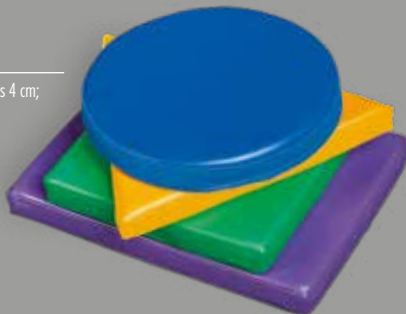

11 elements

**Geometric shapes**
**PS2106**

- 11 figures made from foam covered with PVC fabrics;
- thickness 10 cm



# BALL POOLS

Therapeutic pool made of polyurethane foam with increased density, covered with Oxford or phthalate-free PVC fabric. The pool can be illuminated on side walls. The colour of the lights or the dynamic colour change function can be controlled by a remote control. The inside of the pool is filled with transparent or colourfull balls made of plastic. They stimulate tactile receptors and relieve muscle tension. Pool's lighting stimulates the sense of sight.



## LED STRIP

1. self-adhesive LED strip
2. remote control for changing colors
3. power supply

Backlight with LED strip. In order to achieve the best visual effect, we recommend combining the LED strip with transparent balls.



# OXFORD



Softplay pool round  
**NS2100**

- dim.: 1,5 m; colorful balls 1000 x light grey and light blue

## Led strip round **NS3503**

- length: 400 cm



Softplay pool square  
**NS2000**

- dim.: 2 x 2 m; colorful balls 4000 x white, grey and turquoise

## Led strip square **NS3500**

- length: 650 cm



Softplay pool square  
**NS2001**

- dim.: 1,5 x 1,5 m; colorful balls 4000 x white, grey and turquoise

## Led strip square **NS3501**

- length: 450 cm

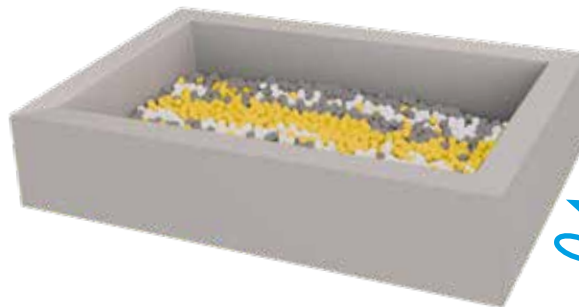

Softplay pool rectangle  
**NS2002**

- dim.: 3 x 2 m; colorful balls 5000 x grey, yellow and white

## Led strip rectangle **NS3502**

- length: 850 cm



## STAIRS FOR SQUARE AND RECTANGLE POOLS

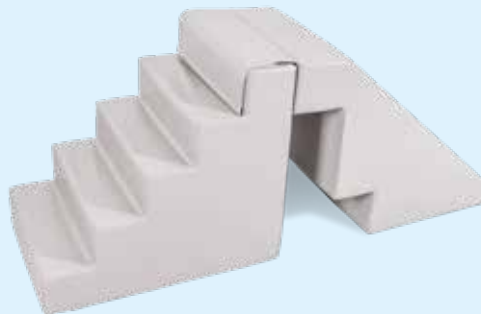

### Stairs with a slide for softplay ball pools **NS1290**

- dim.: 60 x 200 x 80 cm;
- material: polyurethane foam covered with non-slip PVC fabric in dove grey and grey colour;
- intended use: ball pools square and rectangle where it can serve as the stairs and the slide;
- two elements, the stairs, dim.: 89 x 69 x 80 cm and the slide, 110 x 60 x 80 cm;
- the two are connected with Velcro;
- the stairs have got 5 steps

**PVC**



**Corner Ball Pit Ocean  
NS2168**

Playing in a ball pit is always fun. Moving through the balls develops a sense of balance and motor co-ordination. It will also help in teaching colours, training hand

accuracy and manual dexterity. It is ideal for rehab activities. The three construction elements are fastened with strong Velcros.

- 3 elements: 155 x 30–55 cm;
- wall thickness ca. 15 cm;
- the set includes 1000 light plastic balls



velcro-fastening panels

**Play Corner Ocean - set  
NS2169**

A safe three-piece play corner

- 2 walls: 155 x 30–55 cm;
- quarter circle mattresses: 140 x 140 x 10 cm



**Almond-shaped  
NS2101**

- 3 elements;
- L 160 cm, W 120 cm, H 40 cm;
- wall thickness 15 cm;
- 1000 plastic balls, ø 6,5 cm



**Flower pool  
NS2207**

- 7 elements:  
pool – dim.: 100 x 30 cm,  
6 petals: light blue (10 cm), purple (15 cm), green (15 cm)  
orange (20 cm), red (20 cm), blue (25 cm);
- transparent balls included (500 pcs)

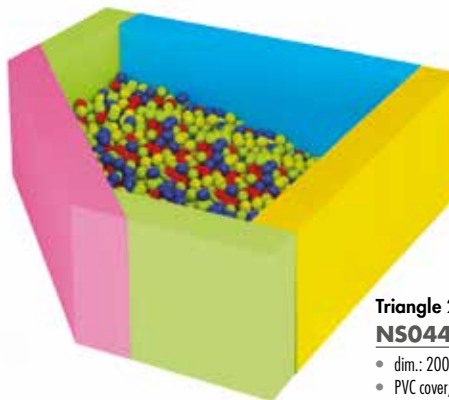

**Triangle 2 x 2  
NS0443**

- dim.: 200 x 200 cm;
- PVC cover;
- 3000 plastic balls, ø 6,5 cm



## MANY COMBINATIONS

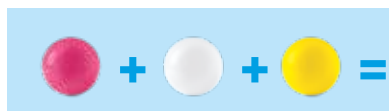
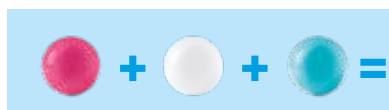
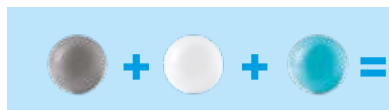

## BALLS

Set of balls which can be used to fill a dry pool or a playpen. Their resilience, size and variety of colours provide psychomotor stimulation

and positively influence sensory development in children.

- 500 pcs; diam. of the ball: 6,5 cm;
- material: plastic



**Grey**  
**NS9800**



**White**  
**NS9801**



**Turquoise**  
**NS9803**

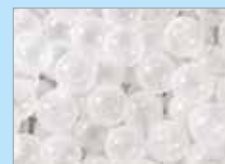

**Transparent**  
**NS0012**

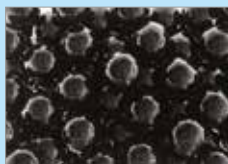

**Black**  
**NS9802**



**Fuchsia**  
**NS9804**



**Yellow**  
**NS9805**



**Colourful**  
**NS2012**

# SENSORIAL INTEGRATION

## SQUEEZERS



### Squeezie seat NS2174

This comfy chair gently squeezes, applying soothing pressure and sensory input through the trunk. Helps align the spine for better seating posture. Enables kids to rock back and forth and improve focus during reading, listening and class time. Helps kids with sensory processing disorder, autism or ADHD. Use with adult supervision.

- dim.: 80 x 25 x 76 cm



### A-shaped squeezie seat NS3169

A-shaped squeezie seat in the form of the letter "A" gently compresses, having a calming effect and thus improving concentration. It helps children with sensory processing disorders, autism or ADHD. For use under the supervision of an adult.

- dim.: 80 x 22 x 75 cm, seat height 32 cm;
- cover: PVC fabric;
- filling: highly resilient polyurethane foam;
- age: 4+



### Canoe NS2173

Canoe is the perfect squeeze for kids who crave calming pressure around their bodies. Helps children with sensory processing disorder, autism and ADHD.

- dim.: 56 x 170 x 49 cm;
- age: 4+



buckle





### **Pancake. Therapy carpet NS8995**

Therapy aid designed especially for sensory therapy. The child should be carefully rolled into a pancake – carpet so as to ensure adequate pressure and stimulation of the receptors. The specialist or the parent can additionally massage, press or compress the child inside the pancake. The product is equipped with Velcro straps which allow the child to easily get out of the pancake. Thanks to this kind of therapy the child can observe an increase in awareness of their own

body as it stimulates the vestibular, proprioceptive and tactile systems. The product is recommended not only for children with sensory processing disorder, but also for those who love cosy tight spaces. The soft pancake is made of nice to touch Minky fabric and it is filled with polyurethane foam. Its characteristic round embossing on the surface and its dimensions allow to use it as a therapeutic carpet during theme or floor games.

- dim.: 100 x 118 cm;
- material: Minky fabric in turquoise and grey colour;
- filling: foam 1,5 cm thick



Please watch our movie about Special Educational Needs



### **Sensory roll-up mattress NS3145**

A soft and light mattress which can be used in many ways, for example, as a cosy layer separating playing or resting children from a cold surface. Thanks to its wavy shape, it works well

as a sensory path as well. It transforms into a seat when leaned against a wall or a therapy rug when rolled-up.

- dim.: 120 x 100 x 4 cm;
- cover: oxford fabric;
- filling: shredded foam;
- age: 3+



### Elastic sensory tunnel NS3168

An elastic tunnel for deep stimulation helps children to develop mobility, strength, and endurance as well as awareness of their own bodies. However, it may also provide space for relaxation as it can be used to hide to rest or even read a book. The fabric gently hugs the body, it stretches

to fit children inside and later returns to its regular size. Suitable for indoor or outdoor use. Recommended especially as a therapy aid for those with sensory integration disorders or motor system dysfunctions.

- dim.: 750 x 150 cm;
- material: lycra; colour: blue;
- washing: 40°C;
- age: 3+

A body-sized elastic sack for stimulating the proprioceptive system. It enhances the awareness of one's own body, which is very important for persons with sensory integration disorders. By exerting pressure on the body, the bag also reduces self-stimulatory behaviours. It increases concentration and develops motor coordination. It has a zip fastener for quick and easy getting in and out.



### - Size M NS2265

- size M; length 120 cm; material: lycra; colour: grey

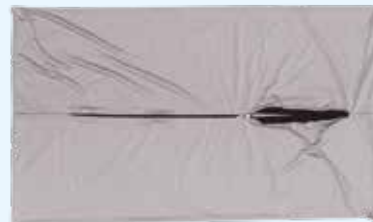

### - Size L NS2266

- size L; length 142 cm; material: lycra; colour: blue



### - Size XL NS2267

- size XL; length 167 cm; material: lycra; colour: green







### Small squeeze machine NS9069

Therapeutic aid made of laminated plywood, PVC fabric and rubber. The body roller is equipped with the tension regulation system in order to adapt it to the user's needs.

- dim. of the body roller when folded: 75 x 68 x 37 cm;
- dim. of the body roller when unfolded: 107 x 68 x 37 cm;
- 3 rollers in marine colour

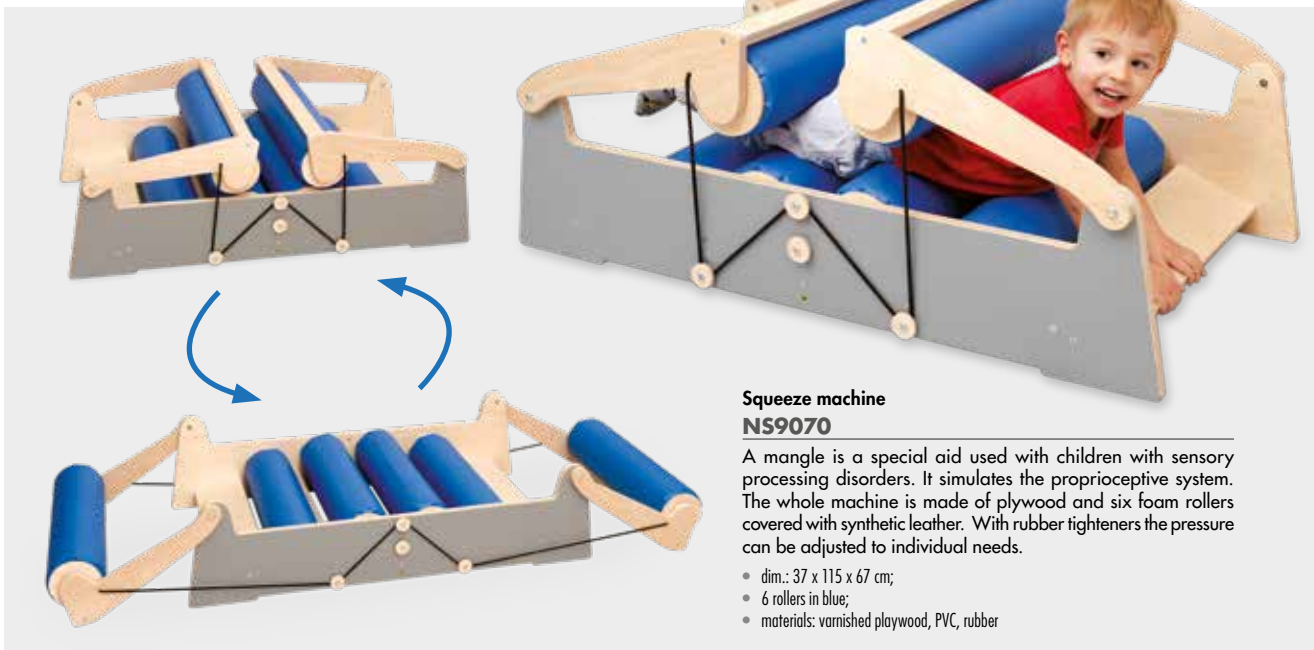

### Squeeze machine NS9070

A mangle is a special aid used with children with sensory processing disorders. It simulates the proprioceptive system. The whole machine is made of plywood and six foam rollers covered with synthetic leather. With rubber tighteners the pressure can be adjusted to individual needs.

- dim.: 37 x 115 x 67 cm;
- 6 rollers in blue;
- materials: varnished plywood, PVC, rubber

# SENSORY TUNNELS & MATS

Solid and thought through therapeutic aids are indispensable in rooms intended to meet special educational needs. They were designed with the unique needs of students in mind, in order to provide the best solutions for them. The used materials ensure durability and the comfort of use.



## Sensory tunnel NS8993

Sensory tunnel is an indispensable aid during the sensory integration therapy. It is especially recommended for children with autism spectrum disorder, cerebral palsy syndrome or Down syndrome. This product was designed to give children the possibility to feel tactile stimuli and it provides deep pressure stimulation when going through, rolling or lying in the tunnel. The tunnel can also serve as a hiding place where a child can hide and

calm down their emotions or just relax. The product's construction provides additional tactile stimulation. The specialist or the parent can roll, put pressure or massage the person inside the tunnel. This aid is entirely made of durable Oxford fabric and its walls are filled with cut pieces of polyurethane foam, which due to resilience retain their properties for longer than the commonly used polystyrene granules.

- dim.: length: 100 cm, inner diam.: 50 cm, outer diam.: 80 cm; material: Oxford fabric in marine colour and two shades of grey;
- filling: cut pieces of polyurethane foam



## Barrel NS2175

Get ready for a barrel of fun! Kids roll, push, climb over and through this colorful barrel for hours of active play. Encourages motor planning, gross motor development and socialization. Foam-packed walls provide a soft cushion as kids move in and out. Durable for heavy use at schools, sensory rooms and therapy clinics. Use with adult supervision.

- size: 81 x 96, hole diam. 40 cm;
- age: 3+



Please watch our movie about  
Special Educational Needs



**Caterpillar. Sensory path and hoop**  
**NS3167**

This path and hoop when fastened with Velcro, the sensory aid creates a circle inside of which children can go on all fours and move just like a caterpillar. When unfastened, the circle becomes a 4 m long, soft, sensory path for walking,

crawling or rolling. It develops balance and proprioceptive system as well as strengthens the muscles. By using the path, children also gain awareness of their own bodies and movements. Cover with a zipper.

- dim.: 44 x 390 x 9 cm;
- material: Oxford fabric in blue and grey colours;
- filling: high resilience polyurethane foam





**Doughnut. Sensory seat**  
**NS2292**

Seat in the shape of a doughnut with icing intended for sensory stimulation. Colorful pieces made of fabrics with different textures and fastened with velcro activate perfectly the sense of touch and sight. The filling in the form of pieces of polyurethane foam, enables easy and

quick adjustment of the seat's shape to the body of a small patient. Phthalate-free PVC fabric and non-slip bottom ensure safe and comfortable usage.

- outer ø: 120 cm;
- inner ø: 60 cm;
- 8 pieces fastened with velcro;
- material: Minky fabric, denim, phthalate-free PVC fabric, non-slip PVC fabric, velor fabric



**Pizza. Sensory mat**  
**NS2293**

Sensory mat in the shape of a pizza with pieces of vegetables and bacon fastened with velcro. Thanks to the moving parts the therapeutic work involving stimulation of the sense of sight and touch will be easier and more intense. It will provide children with many hours of creative experiences with different shapes and combinations. Phthalate-free PVC fabric and non-slip bottom ensure safety and comfort of use.

- dim. of the mat with rim: 140 cm;
- 16 pieces fastened with velcro: 2 x tomato, 2 x broccoli, 2 x olive, 2 x pickle, 2 x mushroom, 2 x basil, 2 x bacon, 2 x salami;
- material: denim, velor fabric, phthalate-free PVC fabric and non-slip PVC fabric

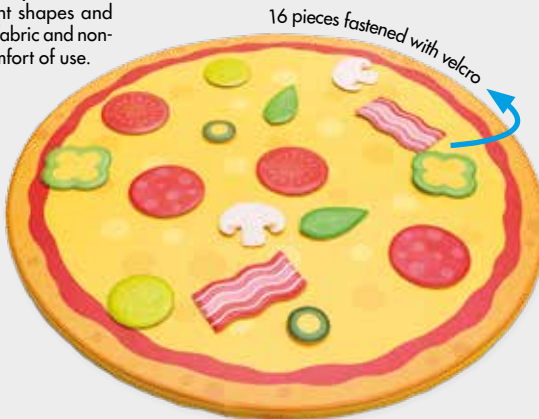

# WEIGHTED AIDS

Weighted aids are specialist equipment in the therapy and rehabilitation of people with sensory integration disorders. While used, they gently press the body and stimulate the vestibular-proprioceptive system responsible for the 'deep touch'. Receptors in this system are found in muscles and tendons and they provide information about the orientation of our limbs in space. According to individual needs, stimulation of proprioceptors relaxes, calms down,

raises the awareness of one's body, improves focus and concentration, limits self-stimulation and helps eliminate fear, anxiety or insecurity. The aids for sensory integration are made of fabrics distinguished for colours, design and quality. They are filled with safe glass bead granulate whose amount and weight depends on the user's weight and height. All the products can be machine-washed at 30 degrees with light spinning, without having to remove the filling.

## WEIGHTED CATERPILLAR

### NS3406

The inside of the duvet consists of 8 panels filled with glass beads and 6 pairs of legs to ensure that the weight is evenly distributed along its entire length. The cover is made of soft Minky fabric with sensory insets.

- dim.: 138 x 46 cm;
- cover: Minky fabric;
- filling: glass beads;
- weight 2,5 kg



## WEIGHTED VEST

- material: Minky fabric, patterned cotton fabric;
- adjustable straps with 4 white plastic buckles



- size S, grey, hedgehog-patterned  
**NS2251**

- size S: height 110 - 125 cm, chest circumference 50 cm weight 2,1 kg



- size M, cobalt blue, anchor-patterned  
**NS2252**

- size M: height 125 - 140 cm, chest circumference 60 cm weight 2,8 kg



- size L, turquoise, teddy bear-patterned  
**NS2253**

- size L: height 140 - 155 cm; chest circumference 70 cm weight 3,6 kg

## WEIGHTED BLANKET

- material: Minky fabric, patterned cotton fabric

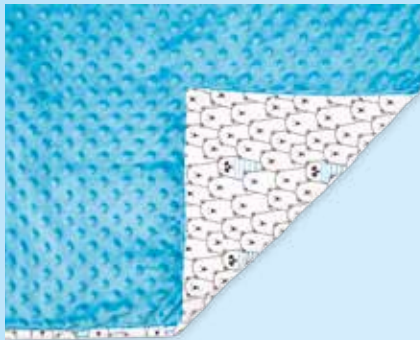

- size L, turquoise, teddy bear-patterned  
**NS2256**

- size L: 100 x 150 cm, quilted, weight 4 kg



- size S, grey, hedgehog-patterned  
**NS2254**

- size S: 60 x 100 cm, quilted, weight 1,5 kg;



- size M, cobalt blue, anchor-patterned  
**NS2255**

- size M: 90 x 120 cm, quilted, weight 3 kg





### Weighted blanket for thighs NS2289

Weighted aid in the form of a blanket for the legs is especially recommended for those suffering from sensory disorders. It is used to stimulate deep pressure which is necessary for the motor development in children. It stabilizes the work of the nervous system, improves coordination and has a positive effect on the development of the body awareness. The blanket is made of soft to touch Minky fabric and cotton with hedgehogs print.



The inside is filled with glass granulate enclosed in a quilted cotton lining. The product can be washed in the washing machine at 30 degrees with a slight spin, without removing the filling.



### WEIGHTED COLLAR

- material: grey Minky fabric, patterned cotton fabric
- adjustable strap with a white buckle



#### - size S, grey, hedgehog-patterned NS2248

- size S: height 110 - 125 cm; weight 0,8 kg



#### - size M, cobalt blue, anchor-patterned NS2249

- size M: height 125 - 140 cm; weight 1 kg



#### - size L, turquoise, teddy bear-patterned NS2250

- size L: height 140 - 155 cm; weight 1,2 kg



### Wrist weights 0,5 kg VX0050

- weight: 0,5 kg;
- material: polyester; filling: plastic granulate, iron balls



### Ankles weights 1 kg VX0001

- weight: 1 kg;
- material: polyester; filling: plastic granulate, iron balls



### Weights for wrists and ankles NS2288

Universal weights intended for arm and leg exercises. They facilitate the formation of correct motor coordination, training proper motor skills and movement planning. The adjustable velcro strap makes the weights possible to fit to the chosen body part. They are made of durable denim and pleasant to touch Minky fabric, which makes the weights soft in contact with the skin. Quilted lining made of cotton is filled with metal beads.

- 2 pcs: dim.: 25 x 8,5 cm; weight: 1 kg;
- material: grey denim, Minky fabric in grey, cotton;
- filling: metal beads;
- regulation: velcro strap; metal beads

# SENSORY ROOM

## WOODEN CAGES

System can be expanded with elements for hanging. It is a perfect diagnostic and therapeutic addition in a neurologic, orthopaedic, psychological and pedagogical development. System consists of series of equipment dedicated to various movement activities in important areas of motoric development. Their presence at a specific age causes easy functioning in the environment. It checks blanking of primary reflexes and motoric-sight coordination, it shapes the postural reflexes. What is important, it builds the image of a child in both big and small motoricity, cooperation with surroundings, ability of team work and movement planning. Furthermore, it tests movement coordination, movement copying, laterality of the body and the degree of excitability of the vestibular system as well as the balance. System is a great link in various complementary diagnostics. The therapy based on the need of movement and senses stimulation. The child takes part in creating the activities, overcomes the lacks in development and the therapist dedicate appropriate exercises. System enables better existence in the environment, improves concentration, the ability of gaining knowledge, improves physical endurance and increases adaptation skills in a changing situation. System in standard version consists of:

- wooden frame with unique fast assembly system;
- wall for climbing with grips;
- UP & DOWN wall;
- wall for climbing with holes;
- rope net;
- ceiling frame;
- up to 300 kg;
- available in 2 sizes

### Mattress NS2177

- 4 panels;
- dim.: 122 x 123 x 5 cm;
- folded 244 x 246 x 5 cm

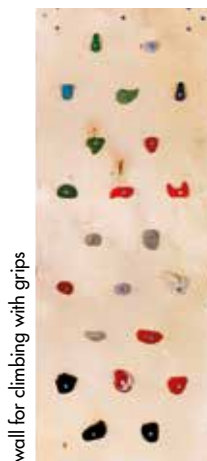
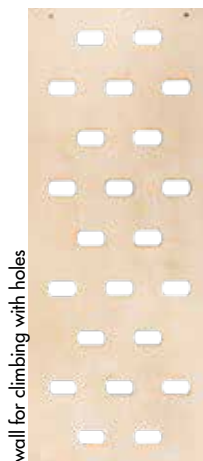
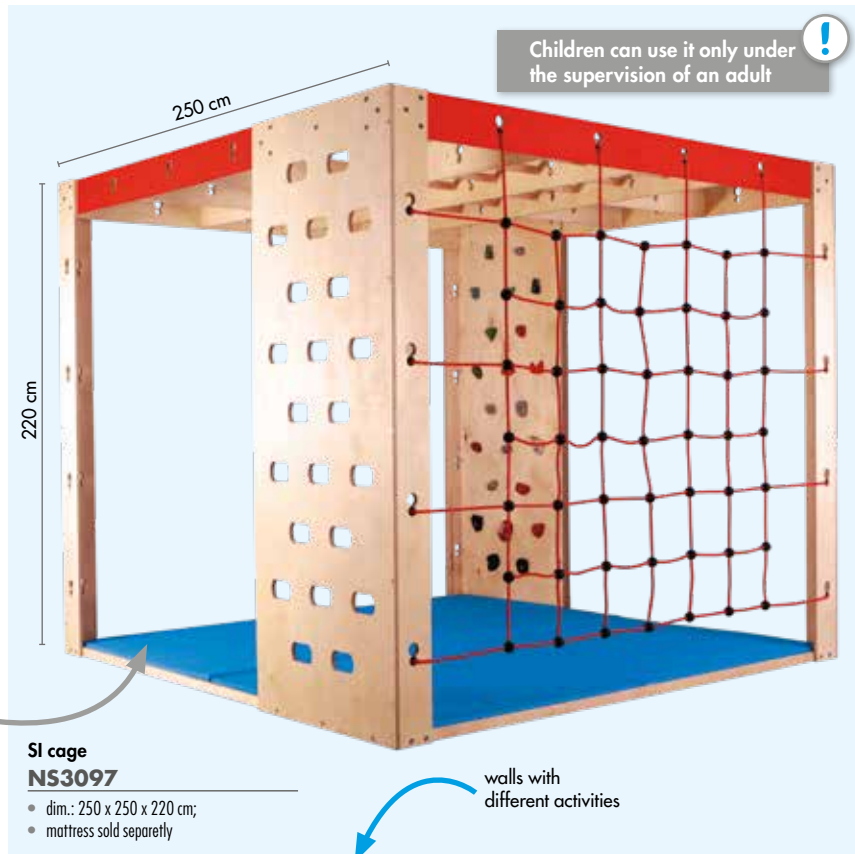



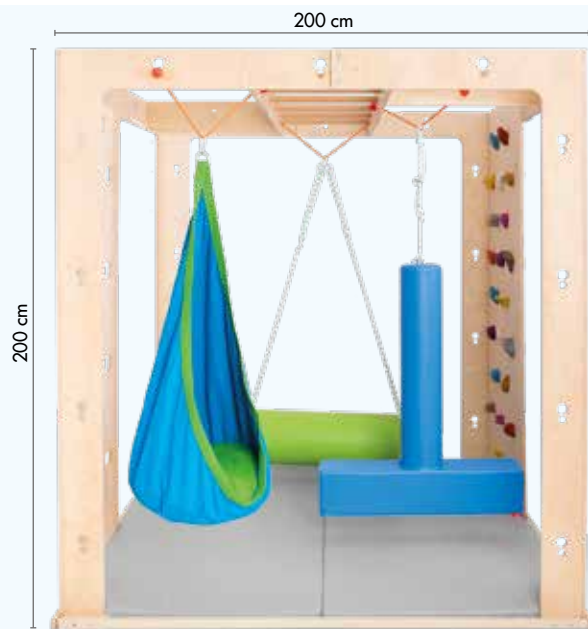

CAVE SOLD  
WITHOUT  
SWINGS  
AND  
MATTRESSES



### Small SI cage NS3109

Small SI cage perfect for sensory integration exercises. The system can be upgraded by the addition of hanging elements. It is equipped with many items which promote the development of motor skills. Inside, you can find a two-sided climbing wall. On one side of the wall, there are stone hand holds, and on the other, there are wooden

notches. The SI cage also has got a board with holes for climbing as well as ladders on the ceiling. Holes were placed in the ceiling structure to facilitate the process of mounting the brackets.

- plywood natural;
- dim.: 200 x 200 x 216 cm

Children can use it only under the supervision of an adult



### Mattress for the small SI cage NS2219

It's made of durable, easy to clean and disinfect fabric.

- dim.: 196 x 193 x 3 cm; colour: grey



Please watch our movie about Special Educational Needs

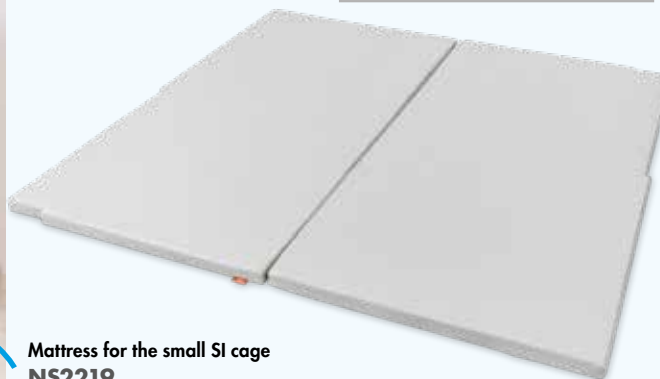



**Pull-up bar 1 with adjustable height  
NS9167**

The rod with the middle attachment is used for pulling up, balance exercises, sagging - movement coordination and strength. It is an additional element to equip the SI room. The rope with 3 balls allows you to adjust the height of the rod.

- bar D 3,5 cm, W 49 cm;
- 3 heights: 135, 150, 165 cm;
- max working load 80 kg



**Hanging ladder  
NS3098**

- dim.: 50 x 4,5 x 195 cm



**Pull-up bar 2 with adjustable height  
NS9168**

Stick with two ropes for fixing. It is used for pulling up, balance exercises, sagging - motor coordination and strength. It is an additional element to equip the SI room. The rope with 3 balls allows you to adjust the height of the rod.

- bar D 3,5 cm, W 49 cm;
- 3 heights: 135, 150, 165 cm;
- max working load 80 kg

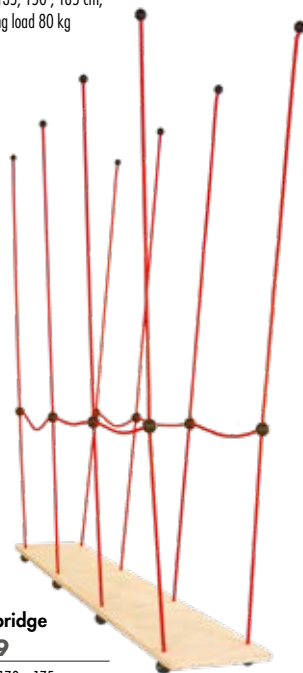

**Wodden bridge  
NS3099**

- dim.: 30 x 170 x 175 cm



**HANDLES FOR SUSPENDED ELEMENTS**

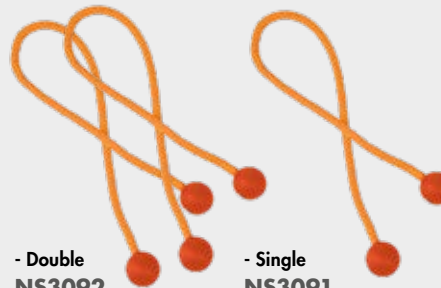

**- Double  
NS3092**

**- Single  
NS3091**



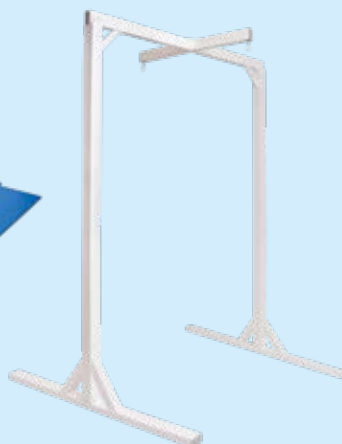
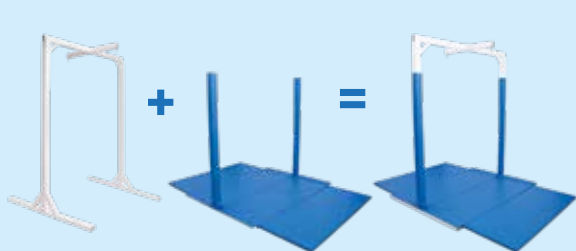

## METAL FRAMES



### Support structure for SI room NS9073

The support structure is made of steel tubing and is intended for creating a sensory integration space in small rooms by hanging SI equipment. The structure is stable and hold up to 100 kg. The essential accessories are a mattress and padding (NS2270). They ensure safety and comfort of use by cushioning bumps during activity. Their assembly is quick and easy thanks to Velcro fastening. The structure requires assembly and comes in 3 cardboard packages.

- dimensions after assembly: 240 x 210 x 160 cm;
- material: steel, colour: white;
- maximum load 100 kg;
- fastening: M10 bolts through brackets (included)

### Mattress and padding for SI room NS2270

#### Mattress:

The mattress consist of several parts and when folded it takes less space and is easy to store. It ensures safety and comfort of use during activity with a SI frame or wall bars, or as an element of an obstacle course.

- dim. when unfolded: 182 x 300 cm, T 3cm;
- material: PVC
- filling: foam; colour: blue

#### Padding:

Padding is an essential element of the frame for hanging equipment in SI therapy. It guarantees safety and comfort of use by cushioning bumps during activity. It can be quickly and easily mounted on the frame thanks to Velcro fasteners.

- 6 pcs:  
2 x 10 x 10 x 200 cm,  
4 x 9 x 5 x 70 cm;
- material: PVC, filling foam;
- colour: blue; velcro fastening;



**Sensory suspension frame  
NS3110**

Ceiling suspension frame. It must be fixed to a wall made of hollow brick, brick or reinforced concrete. The frame cannot be mounted on plasterboard.

- regulation: from 3 to 4,4 m
- material: powder coated steel in white colour

Can be installed on:

- hollow brick wall
- brick wall
- reinforced concrete



**THERAPEUTIC SWINGS**



**Therapy swing - board  
NS8991**

- square-shaped swing;
- weight: 9 kg;
- material: plywood, rope and foam covered with PVC fabric;
- the method of suspension: ceiling mount;
- intended use: swinging;
- dim.: 61 x 61 cm



**Therapy swing - T-shaped**  
**NS8992**

- material: metal frame and foam covered with PVC fabric;
- the method of suspension: ceiling mount;
- intended use : swinging;
- dim.: 86 x 102 cm;
- the diameter of the swing: 18 cm



**Soft swing**  
**BO5562**

- high-density foam seat with a wooden frame;
- size: 30 x 87 cm



**Bolster swing**  
**NS8990**

It consists of a metal bar, sturdy length-adjustable straps and a high-density foam seat with a steel frame inside for rigidity.

- size: 127 x 30 x 40 cm



Please watch our movie about  
Special Educational Needs



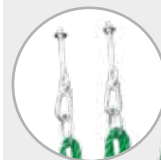

### Wooden rehabilitation swing – blue BO4505

Therapeutic swing for stimulation of the vestibular system, improvement of the hand-eye coordination, exercising dynamic balance and postural response. Can be used in sitting and standing positions. Equipped with two wooden handles and a platform with non-slip surface. Everything is suspended on adjustable plastic ropes fixed at 4 points of the platform and at the end of the handles. The swing is suspended with 2 carabiners not included.

- dim.: platform: 80 x 1,8 x 20 cm;
- regulated height up to 160 cm;
- material: wood, EVA foam, plastic, metal;
- age: 3+

### Hanging swing BO5418

Hammocks give children a calm and sweet place to play and rest. Uniform swing motion can stimulate child's sense of balance and encourage development.

- product size: 70 x 70 x 140 cm
- main material: terylene, fill material: polyester

### Swing chair BO5534

A swing chair on two adjustable ropes. A solid construction on a sturdy steel frame. The high back and deep seat provide a large sitting area. The product requires assembly.

- dim.: 50 x 137 cm;
- height adjustable up to 150 cm;
- maximum load 150 kg

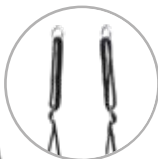

### Net swing BO5804

High quality indoor&outdoor swing set.

- height: 160cm (adjustable);
- steel tube: ø 25 x 1,2 mm;
- net rope: ø 6mm PE;
- rope suspension: ø 10 mm PE;
- black foam thickness: 10 mm;
- max loading: 200 kg; hoop: ø 5,0 x 50 mm;
- swing foam binded with PP ribbon

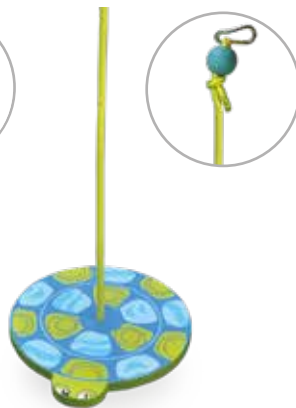

### Turtleswain board BO5065

- adjustable height (180 cm);
- durable materials: solid wood and 10 mm PE rope;
- seat size: 34 x 2 cm



### Fabric swing BO5412

- product size: ø 100 cm;
- foam tube: 5 mm thickness;
- seat: PP mat;
- rope suspension: ø 10 mm PE

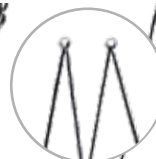

### Rec swing BO4553

- assemble size: 102 x 76 cm;
- steel tube: 32mm;
- foam tube: T-6mm NBR;
- hanging rope: 10 mm PE;
- height: max 180 cm, adjustable;
- seat: PP mat;
- PP webbing: 38 mm



**Hammock  
BO2001**

- size: 200 x 80 cm; material: polyester-cotton blend;
- colour: blue - green - navy blue;
- load: up to 150 kg; age: 3+



**Hammock with a bar  
BO2002**

- size: 200 x 80 cm, material: polyester-cotton blend, wood;
- colour: blue - green - navy blue;
- load: up to 150 kg; age: 3+

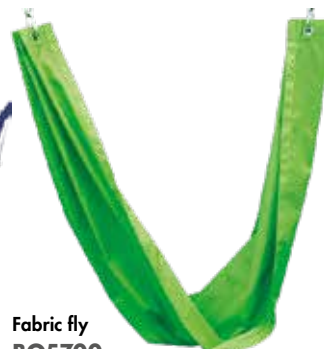

**Fabric fly  
BO5700**

- material: 600D polyester;
- with extension rope

**Climbing rope  
with wooden steps  
BO4510**

Climbing rope is a classic climbing rope with that extra something. The subtly styled round wooden steps give extra grip when climbing. Material and workmanship leave nothing to be desired! This cool climbing rope is the 'thing' to have, and will fit any climbing frame.

- height: 200 cm;
- UV Resistant PE rope: 26 mm;
- 3 pcs wooden steps, ø 10,5, H 3,8 cm

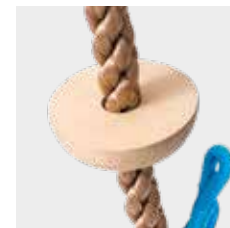

**Carabiner clip  
for suspended equipment  
BO9405**

Universal solution for mounting swings, climbing ropes, ladders, climbing nets and other accessories.

- ø 1 cm, length: 14 cm;
- material: metal, load: up to 120 kg



## SNOEZELEN THERAPY



Mirrors are an important addition to every therapy or sensory room. The reflections of people or objects create an illusion of endless space. Children can have an extraordinary sensory experience thanks to the changing images and lights while playing inside the mirror playhouse. This therapy aid holds attention and arouses curiosity in everyone who decides to step inside.



### Therapeutic mirror play house NS3146

This house with mirrors on the walls and ceiling is a valuable aid during therapy and classes for children with special educational needs. The cosy interior has a calming and relaxing effect while it also stimulates the senses. We highly recommend to combined it with light therapy. The mirrors might be also useful during speech therapy sessions as little one will be able to closely observe the movements of their faces.

- dim.: 100 x 103 x 92,5 cm;
- material: laminated chipboard, varnished plywood, safe plexi-glass mirrors;
- age: 2+; the mattress (NS3143) is sold separately

### Mattress for the therapeutic mirror play house NS3143

A soft mattress for the mirror house. Cover with a zipper.

- dim.: 94,5 x 92 x 4 cm;
- material: Oxford fabric;
- filling: high resilience polyurethane foam; colour: blue



### White house. Hiding place BO2004

A white house which creates a cosy and private space for playing games, sensory therapy, or relaxation. The curtains in the windows can be rolled-up and secured with ribbons. The house requires self-assembly.

- dim.: 120 x 120 x 150 cm
- material: cotton, frame made of plastic
- age: 3+



### Therapy tent RV0014

Foldable tent which can be used during therapy or as a space for children to play. It has got an entrance and one window with the possibility of tying a curtain to open the space. The inside of the tent can be converted into a closed sensory space filled with lights to make children feel safe.

- dim.: 120 x 120 x 180 cm;
- colours: silver-grey outside, black inside;
- material: flame-retardant polyester taffeta, polythene, tent's frame;
- plastic; storage: fabric bag;
- age: 3+



### Dark den BO0202

- silver inside;
- material: 170T polyester;
- size: 110 x 110 x 110 cm





### Mirror corner for therapy NS2295

The mirror corner is a perfect place to rest, use relaxation techniques, support development and for therapy of dysfunctions. It enables the contact with different feelings and experiences through multiple senses. Equipped with 2 walls with mirrors made of safe acrylic glass which enhance the sensory experiences. The comfort of use is ensured by the corner mattress and roller, made of polyurethane foam with increased density and phthalate-free PVC fabric. The set is

complemented by a cotton canopy with a blue felt frill, which will create an asylum from the amount of sensory experiences.

- The set consists of:
- 2 walls with mirrors made of plastic with dim. 142 x 4 x 142 cm, material: polyurethane foam, PVC fabric, colour: white;
- 1 corner mattress with dim.: 142 x 5 x 142 cm, material: polyurethane foam, PVC fabric;
- non-slip fabric; colour: white;
- 1 roller with dim.: 25 cm, length: 110 cm;
- material: polyurethane foam, PVC fabric; colour: white;
- 1 canopy with dim. 145 x 145 cm;
- material: white cotton, sky blue felt; metal;
- fastening elements not included in the set



### White roller for therapy NS2297

- ø 25 cm, length: 110 cm;
- colour: white;
- material: polyurethane foam, phthalate-free PVC fabric



### White mattress for therapy NS2296

- dim.: 142 x 5 x 142 cm;
- colour: white;
- material: polyurethane foam, phthalate-free PVC fabric



### Canopy for the mirror corner NS3171

Equipped with blue felt frill and 3 metal hoops to hang the canopy on the wall.

- dim.: 145 x 145 cm;
- material: white cotton, blue felt, metal, fastening elements not included in the set



### Mirror pyramid RV0006

- size: 120 x 105 x 57 cm;
- made of metal covered glass and beech wood; ages: 3+ / kaleidoscope effect



## LULA CUSHION CORNER

Soft, round and square cushions in white colour with non-slip bottom. Perfect for therapy corners or sensory rooms. Its light colour has got a calming effect while the soft filling gives a sense of comfort and security.

- dim.: 120 x 120 x 30 cm. PVC case with a zipper;
- filling: polyurethane foam granules; it is equipped with an inner cover

**White round cushion  
NS3166**



**White square cushion  
NS3165**



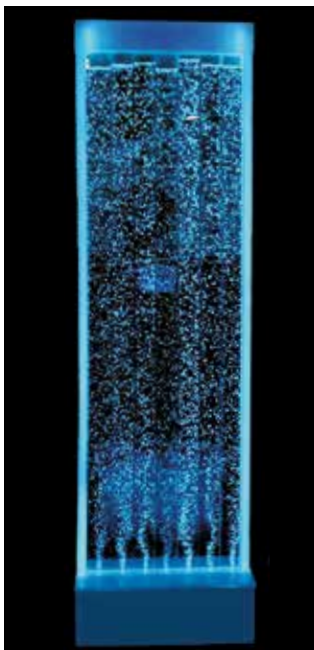

### LED Bubble water wall RV0009

Illuminated panel which can be filled with water made of safe acrylic glass. There are 11 light modes controlled by the remote. Thanks to this product it is possible to create a therapy corner perfect for sensory rooms and sensory integration. The colourful light panel with water stimulates the sense of sight and it has got a calming effect. Playtime with it helps to improve attention and focus. To be used under adult supervision at all times. Material: acrylic glass, plastic. The set includes: a base with the panel which can be filled with water, remote control for changing the light modes, hand pump for filling and draining water, air pump.

- dim.: 60 x 22 x 180 cm;
- weight: 28 kg;
- age: 3+



### Glowing pillow RV0017

Glowing, colour-changing pillow made of soft cotton gently illuminates the room. It creates a unique and cosy atmosphere thanks to the gently shimmering colours. Inside, there is a light source which is controlled by a LED light remote. The pillow can be also activated by lightly pressing it in the middle. This product encourages children to develop their visual and tactile senses. Perfect for sensory integration therapy.

- 2 pcs: a pillow powered by an internal battery, requires 3 AA batteries;
- material: cotton, synthetic fabric;
- age: 3+



### Interactive waterbubble tube BW0001

- made of organic glass;
- glass top corner to mount to a wall;
- modes: backlight, soft colors busting, simultaneous blinking, all colors;
- set with remote control and platform;
- tube size: 170 x 15 cm



### Light up blanket RV0031

Soft and cosy blanket which has a comforting effect thanks to its changing colours and relaxing light. The LED lights do not produce heat what makes it safe to touch. Perfect for a reading corner or a sensory integration room. It provides visual stimulation to people with hearing loss, but it can be helpful during therapy for people with autism or sensory processing disorders. The cover is removable and washable at 30 degrees.

- dim.: 110 x 90 cm; portable, with a battery and a switch;
- requires 3 AA batteries; the cover to be washed at 30 degrees; material: polyester; colour: white; age: 0+

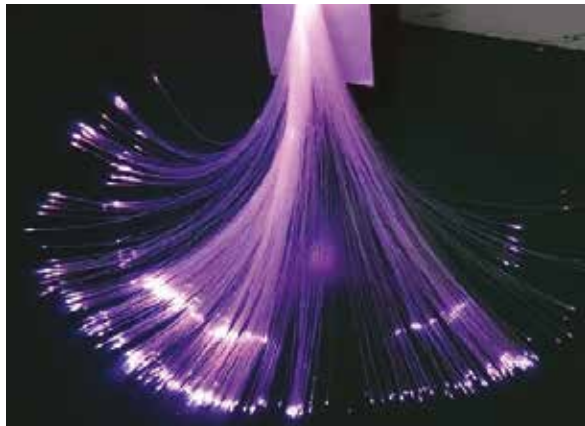

**Fiber Optic shower  
RV0005**

The set is an excellent tool to stimulate the sense of sight. It allows you to obtain soft and relaxing lighting for decorating rooms and for use in the therapy of children with sensory disorders. The light in the fibers spreads evenly along their entire

length. The bundle of all fibers is led to a special terminal - a connector that is easily connected to the light source - generator. The type of light, its effects and the change of colors are made by remote control. The set does not include mounting elements.

- it contains 300 pieces of optical fibers, optical fiber length: 2 m, optical fiber diameter: 0,75 mm

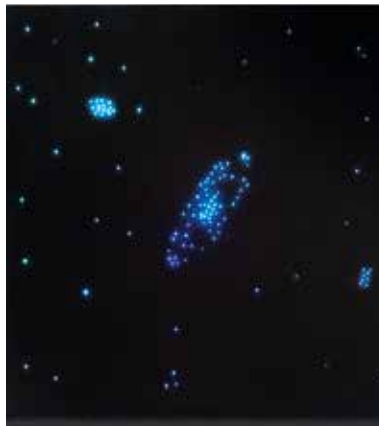

**Panel Starry Sky  
RV0011**

Designed for visual stimulation, relaxation, for interior decoration. Appearing and disappearing images of spiral galaxy and globular clusters on a shimmering starry sky.

- black canvas with woven fiber optics strands, on durable metal frame;
- light source (LED) and power supply built-in;
- size: 70 x 70 cm; powering: 100-265 V, 16 W, 50-60Hz



**Spike light balls  
RV0018**

Covered with soft malleable spikes that make it interesting to touch.

- set of 2;
- age: 0+

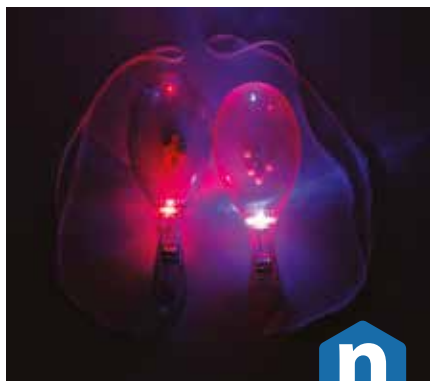

**Glowing maracas  
RV0032**

Maracas, once turned on, react to every movement by emitting coloured light. They are ideal for any fun activities in a room with dim lighting or sensory integration therapy. This aid stimulates the sense of sight, encourages musical curiosity, and develops a sense of rhythm.

- 2 pcs;
- material: plastic;
- age: 3+

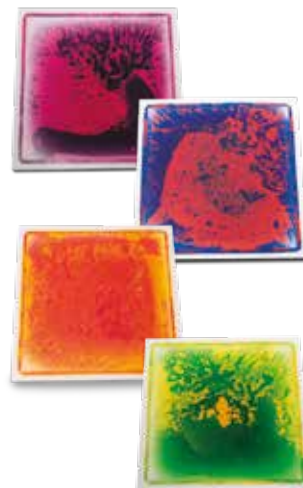

**Glowing liquid tiles  
RV0019**

The colour swirls inside the tiles when you step on them which creates a great tactile and visual experience.

- set of 4;
- dim.: 50 x 50 x 1 cm





### Light hedgehog RV0020

Put on the floor where kids can explore the light strands with their hands and feet.

- ø 40 cm;
- age: 3+



### Therapy LED projector UT0043

Projector with 6 light colours and various modes which can be changed with the use of a remote control. Thanks to different light functions it stimulates the sense of sight. This product can be used in any space, and it serves as a great addition to therapy or sensory rooms.

- dim.: 15 x 18 cm;
- material: plastic; age: 3+



### Fiber optic tree RV0100

LED fibre optic light creates calming and soothing atmosphere. It is perfect as a room decoration or as an aid used in the therapy of people with sensory disorders. Crystals which are placed in

the based enhance visual sensations. The set contains a remote control for changing colours of the lights.

- dim.: 8 x 8 x 33 cm;
- material: ABS;
- powering: 3 x AAA batteries (not included);
- age: 3+



### Light and sound projector. Crystal RV0037

Light and sound projector with the regulation of light intensity. It creates a pleasant environment. There are six modes: cold, warm, flashing, constant and pulsating light.

- battery: 1000 mAh



### Waves projector. Ocean RV0030

A mini projector creates an intriguing and relaxing atmosphere by displaying coloured lights on a ceiling or walls. It transports you to the beach where you can watch the waves late in the evening. The projector supports TF cards, or it can be connected to external devices (audio 3,5 mm), such as: computers, smartphones, notebooks, or MP3 players. This product is easy to use at any time. It projects light in different directions to suit your needs. High power loudspeaker is built in.

- dim.: 12,6 x 12,6 x 10,5 cm; a remote control; age: 0+



**Infinity. Light panel  
RV0012**

Magical object for stimulating the sense of sight. The panel is equipped with LED lights and a set of mirrors which create the amazing illusion of an endless tunnel. The witch-key is placed on the side of

the device. Colours can be changed with the remote control. The product is delivered with a power cord and an adapter.

- dim.: 35 x 13 x 35 cm;
- weight: 3 kg;
- powering: 220V AC;
- age: 3+



**Illuminated mini sandbox  
with sensory sand  
UT0034**

Small sandbox for sensory play. It is a perfect place for creative activities. The bottom of the sandbox is made of transparent acrylic with built-in LED lighting. This combination allows children to trace the sandbox's bottom with their fingers to stimulate the sense of sight and touch. Raised walls prevent the sand from spilling during playtime. The product can be used immediately after unpacking.



- 1 x sandbox, dim.: 40 x 9 x 28 cm, 1 x brush with a dustpan, 1 x power cable, 1 x plug, 2 x sensory sand;
- material: PVC;
- powering: USB port;
- age: 3+



**Illuminated panel of colourful cubes  
UT0035**

Small touchpad made of 5 fields illuminated with different colours. It also produces a pleasant and clear sound. It allows children to play with colourful light and sound. It is a great therapeutic device which engages and stimulates sight, hearing and motion at the same time.

- dim.: 30 x 6,5 x 4,5 cm; material: PVC; powering: 4 x AAA 1,5 V batteries; instruction; age: 3+



**Illuminated colourful wall panels. Honeycombs  
RV0038**

Illuminated light panels sensible to touch. The panels can be controlled by the remote control. There are three lighting modes.

- 5V 2A input charging time; 6 pcs in the set; age: 3+





### Illuminated interactive sandbox RV0300

The table is designed for relaxation, tactile and visual stimulation, imagination development and therapy through play. Parts of the walls are made of beech wood. The bottom of the sandbox is made of transparent acrylic underneath which LED lighting was mounted in order to illuminate the patterns created in sand. Drawings or writing can be made with the use of fingers,



brushes or special combs. On the side of the table there are buttons thanks to which the user can change the colour of the lights. Metal legs ensure stability of the table. The product is delivered with a power cord and an adapter.

- dim.: 63 x 63 x 70 cm;
- material: wood, metal, acrylic;
- powering: 220V AC; age: 3+



Light panel is a universal tool with a wide range of use. Provides a soft backlight, perfect for experimenting with different colours and shapes of the objects. On the table top we can place transparent figures, coloured foils, transparent papers, mirrors. Made of high quality materials, easy to use. It is light weight, durable and completely safe for children.

### Light panel JN0019

- dim.: 47 x 35 cm; size of the illuminated panel: A3 format;
- age: 3+

### Big light pannel JN0020

- dim.: 65 x 47 cm;
- backlit plate area: A2 (58,5 x 41 cm);
- power cord included



### Luminous sensory tambourine RV0050

Luminous tambourine is an amazing addition to sensory play or to rhythmic exercises. The tambourine is made of hard plastic and metal fittings with polished surface. It is light and comfortable to use. The colours emitted by the instrument stimulate the sense of sight while the bells stimulate the sense of hearing.

- 1 pc;
- dim.: 16 x 3,2 x 10 cm;
- weight: 0,1 kg;
- powering: 3 x AG 13 batteries;
- colour is picked at random; age: 3+



## MANIPULATIVE POUFS

### Calming pouf with pockets NS2176

A seat in the shape of a pouf with two pockets on the sides. The pockets have a therapeutic function, allowing the child to calm down and relax

- dim.: 32 x 30 x 32 cm, seat height 32 cm;
- cover: phthalate-free, abrasion-resistant PVC fabric in green
- filling: highly resilient polyurethane foam







## SENSORY PEARS

Comfortable pouffes with sensory elements (bells, pipes, velcros, string loops, laces). Made of PVC fabric. Filled with styrofoam, they can easily adapt to the sitter's position.

- size: 100 x 90 cm;
- weight: 6 kg



### Clown NS2106

The clown has a soft velour cap, loopy hair, long arms with a bell, laced shoes, large buttons and a red nose which squeaks cheerfully when pressed.



### Teddy Bear NS2107

The clown has a soft velour cap, loopy hair, long arms with a bell, laced shoes, large buttons and a red nose which squeaks cheerfully when pressed.

Large and soft cushions mainly for toddlers. The soft snouts, flexible legs and squeaky elements encourage kids to cuddle the toy animals. Made of PVC fabric with velour elements. Stuffed with foam cuttings.

- size: 70 x 90 cm

### Doggy NS2108

The dog has a nose that squeaks cheerfully, pellet-filled ears and soft elastic paws.



### Bunny NS2109

The bunny has a tail that squeaks and elastic ears and paws.

## BIG CUSHIONS

- ø 70 cm;
- size: 110 x 100 cm;
- weight 6 kg;
- easy-to-clean PVC cover;
- granulate inside

choose your colour:

 <b>NS0585 T</b>	<b>rainbow</b>
 <b>NS0585</b>	<b>blue</b>
 <b>NS0585 NI</b>	<b>light blue</b>
 <b>NS0585 CZ</b>	<b>red</b>
 <b>NS0585 PO</b>	<b>orange</b>
 <b>NS0585 ZL</b>	<b>yellow</b>
 <b>NS0585 ZI</b>	<b>green</b>
 <b>NS0585 RO</b>	<b>pink</b>

pear shaped







## SMALL CUSHIONS

- size: 60 x 100 cm;
- weight: 2,6 kg

covered with heavy-duty fabric



choose your colour:

 <b>NS0639 T</b>	<b>rainbow</b>
 <b>NS0639 NI</b>	<b>blue</b>
 <b>NS0639 RO</b>	<b>pink</b>
 <b>NS0639 CZ</b>	<b>red</b>
 <b>NS0639 PO</b>	<b>orange</b>
 <b>NS0639 ZL</b>	<b>yellow</b>
 <b>NS0639 ZI</b>	<b>green</b>

Small  
**NS0639**

- size: 60 x 100 cm;
- filled with granulate;
- weight: 2,3 kg

## PEAR WITH A HANDLE

- size: 107 x 90 cm;
- weight: 5 kg;
- material: PVC;
- filled with granulate



- white-grey  
**NS2294**



- lime-black  
**NS2230**



Successful rehabilitation requires good quality functional equipment. Foam shapes are standard tools necessary for the implementation of therapy. We offer them in many different shapes and sizes. Their inside is made of polyurethane foam, covered with an aesthetic phthalate-free PVC fabric in

various colours. Thanks to foam shapes, the users can effectively train the upper and lower parts of their bodies. Pear-shaped cushions are great for sitting and exercising. They adapt perfectly to the position of the body, and they can be formed according to the needs of the user. Additionally, they can

prove useful during rehabilitation and other therapeutic activities. However, they are also perfect as a comfortable seat. Some models are equipped with a handle which makes moving them from one place to another much easier. Their quality design, high quality granules and durable PVC or

Oxford fabric guarantee long service life. Styrofoam granules, which can be found inside pear-shaped cushions and other rehabilitation cushions, wear out naturally after about a year of intensive use. We recommend refilling the cushions with new granules which you can find under the code: NS1585.



## BIG PEAR-SHAPED REHABILITATION CUSHION

- styrofoam granules

### OXFORD

- dim.: 110 x 100 cm;
- weight: 5 kg



- green black grey  
**NS3310**

- colour: green-black-grey

- blue black navy  
**NS3311**

- colour: blue - black -navy

### PVC

- dim.: 135 x 100 cm;
- weight: 7,5 kg



- grey with a handle  
**NS3320**

- colour: two shades of grey

- beige and grey with a handle  
**NS3321**

- colour: beige - grey

## TEXTURES



**Tactile domino**  
**NS0523**

- base size: 33 x 22 cm;
- 28 boxes size: 9 x 4,3 cm

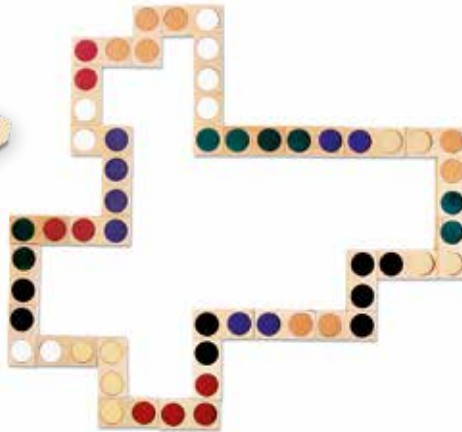

**Touch and match**  
**NS0486**

- A set of wooden blocks with different surfaces.
- 20 pcs (10 pairs);
  - size: 9 x 1 x 4,3 cm;



**Tactile board**  
**NS0522**

- size: 23 x 12 cm



**Panels with textures**  
**NS0894**

- 10 plates;
- dim.: 15 x 15 x 1 cm;
- circle ø 10 cm





**Maximemo with texture  
NS0487**

- in a wooden frame;
- 16 plates;
- 15 x 11,4 x 1 cm



**Watch your steps  
NS1934**

- size: 25 x 25 cm;
- 5 pairs of different density



**Sensory path  
NS0488**

A set of tiles with different textures framed with solid wood.

- 6 tiles; size: 35,5 x 30,5 x 2 cm



**Maths figures.  
Sensory bags in sack  
NS2071**

Colourful sensory bags of different shapes and textures filled with plastic pellets. 6 bags in 6 colours and shapes.

- 6 shapes;
- dim. 15 cm: rectangle, triangle, square, circle, hexagon, diamond
- dark blue drawstring sack dim.: 21 x 25,5 cm



**Treasure candy  
NS2072**

Soft and pleasant to touch candy shaped pillow with manipulation applications for children curious about the world. Cords, buttons, Velcro, buckles, press studs are elements that support the development of motor skills, visual perception and cognitive skills. In addition, it stimulates the child's sense of sight, hearing and touch. Inside the bonbon, we can find sensory accessories of various shapes and textures.



- candy length: 70 cm, diameter: 70 cm;
- 6 sacks in different shapes and textures with plastic balls filling; dim. around 15 cm;
- material: micro-fleece, filling: a blend of cotton and polyester fibers;
- can be washed at 60 degrees C;
- age: 2+



### Sensory Cushions NS2129

Soft rustling cushions in the shape of a circle, triangle, rectangle and square. The vivid colours attract children's attention and the rustling sound encourages them to play.

- circle diameter 30 cm, triangle side 30 cm, square 30 x 30 cm, rectangle 40 x 28 cm;
- granulate inside



### Sensory mittens NS2232

Sensory mittens are a therapeutic aid used for play, massaging and stimulating the tactile and proprioceptive system. Different

textures provide different tactile sensations. Their colour variety helps stimulate sight. Their standard shape and size make them suitable for both children and adults.

- 6 mittens in 6 colours;
- dim.: 28 x 21 cm;
- material: Oxford cloth, drill, velour, cotton cloth, smooth PVC fabric, textured PVC fabric;
- filling: foam



**Sensory clouds.  
Textured cushions  
NS2231**

Individual elements have been made from a characteristic, nice-to-the-touch material in a different colour. These cushions are ideal as a therapeutic tool, in bad posture correction or in sensory integration. They excellently stimulate touch and sight.

- 6 pcs;
- dim.: 45 x 36 cm;
- colours: blue, light grey, grey, yellow, green, orange;
- material: Oxford cloth, drill, velour, PVC fabric, PVC, Minky fabric;
- filling: foam, styrofoam balls, glass balls



**Sensory caterpillar with pockets  
UT0044**

Caterpillar sensory path. Each of the four colourful pockets is detachable with a zipper. Inside, there are small bags filled with sensory material; one can be filled with water. While walking on the caterpillar, children develop their tactile receptors. Bright colours also stimulate the sense of sight and make the product more fun.

- dim.: 180 x 41 cm;
- age: 3+

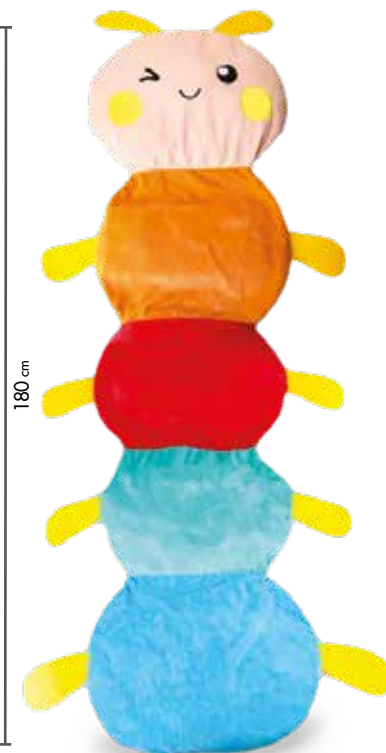



## SENSORY AIDS

### Whale. Massage brush UT0047

- exfoliating and cleaning body;
- gentle massage scalp;
- when taking shower, long silicone bristles are more easily to create lather

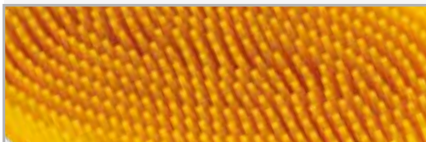

### Ocean. Sensory water mat UT0046

A sensory mat with safe rounded edges and 2 compartments. The outer compartment should be inflated while the inner one should be filled with water. Foam animal will move with every touch. The toy can be used indoors or outdoors. Children can enjoy the vibrant ocean world map and cute floating toys without getting wet. It can be easily filled with water and air without dents. After emptying the compartments, you can fold or roll it up.

- 6 foam elements inside the mat;
- dim.: 66 x 50 cm;
- age: 6 months+;
- a mat made of leakproof PVC

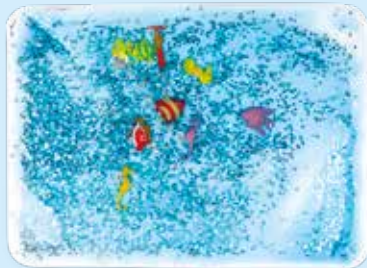

### Ocean Animal liquid filled shape UT0048

- ocean animal liquid filled shape perfect for led light panel;
- different texture ocean animals can train the sense of touch;
- shiny glitter attract children's attention and enhance visual effect



### Sensory gel flower with beads for sorting UT0045

Gel flower filled with a liquid and beads in different colours. It stimulates the nerves of the hand and develops sensitivity to stimuli. The flower can also serve as an aid in learning about colours and learning to count.

- material: PVC; dim.: 19 x 11,5 cm;
- age: 3+



### Anti-stress gel squeeze toy UT0042

Relaxing squeeze toy filled with colourful liquids. When pressed, the two-colour liquid is mixed, and it creates a noticeable visual effect. The product's texture is nice to touch while the soft, gel filling is soothing and calming.

- material: PVC;
- dim.: 22 x 15 cm
- age: 3+



### Sensory gel solids with glitter UT0020

Set of sensory shapes which stimulate the sense of sight or touch as well as serve as an aid during manipulative exercises. We recommend combining them with illuminated panels. Soft and nice to touch elements are filled with a special gel with glitter which creates unique patterns when pressed. All shapes are equipped with Velcro closure to give the possibility of creating 3D shapes from meshes. This product can prove useful when teaching geometry, especially in the case of children on the autism spectrum.

- 4 elements: cube, cuboid, prism, regular tetrahedron; dim.: 19 x 26 cm;
- material: plastic; age: 1+



### Gel letters. Set UT0024

Gel alphabet is perfect for sensory play or learning how to spell. The colourful gel and the textured surface provide plenty tactile and visual sensations. All letters can be combined with illuminated panels. They prove useful during polysensory stimulation or therapy.

- 26 pcs;
- height: 11 cm;
- material: plastic;
- age: 1+

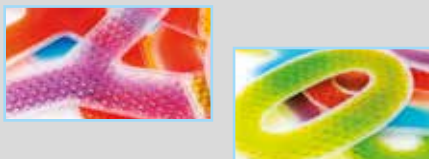

### Gel numbers. Set UT0023

Colourful set of textured numbers. They are perfect for stimulating the senses or for sensory play with the illuminated panel. All numbers are nice to touch and soft. Additionally, they encourage activity, stimulate curiosity and improve concentration.

- 26 pcs; numbers: 0-9;
- height: 10,5 cm;
- material: plastic;
- age: 1+





### Gel shapes. Set UT0021

Shapes filled with gel balls are perfect for sensory play. Through manipulative play, squeezing and pressing children stimulate the sense of touch. When combined with the illuminated panel, the product provides amazing visual sensations.

- 6 pcs: circle, square, triangle, rectangle, pentagon, hexagon;
- material: plastic
- age: 1+



### Therapeutic teethers. Classroom set JN0026

Teethers in the shape of a circle, made of safe and non-toxic material are an effective solution for gentle teething. They are also useful as part of speech therapy prophylaxis. Teethers facilitate the exercises connected to chewing and they can replace the habit of sucking the thumb. Their texture significantly increases the sensory experience by stimulating the child's sensorimotor and proprioceptive system. The construction of the set elements gives a chance to form a chain of any length that can be attached somewhere or hunged.

- 144 pcs;
- size: 7,3 x 4 cm;
- material: plastic;
- age: 18 months +



### Sensory silicone shapes UT0025

Flexible shapes with suction cups spark creativity, inspire curiosity, improve fine motor skills and they stimulate the senses. Colourful elements can create wavy lines or chains; children can also bend or twist them as well as cling them to any flat surfaces. Each shape has a different texture in order to stimulate the sense of touch while their vivid colours stimulate the sense of sight. This set it guarantees many hours of exploratory, fascinating fun.

- 6 pcs: shape: square dim.: 8 x 8 cm, triangle dim.: 4 x 8 cm, star dim.: 8 x 9 cm, heart dim.: 8 x 8 cm, circle diam.: 7,5 cm, rectangle dim.: 9 x 7 cm;
- material: silicone; age: 1+



## DE-STRESSING AIDS

Colourful, soft stress relief toys in different shapes are made of special materials which allow the user to squeeze them in all possible ways. Products we offer not only develop the sense of touch, provide new stimuli and different textures, but also, they have a great influence on the development of

fine motor skills. Additionally, they serve as a stress reliever because they help to ease tension, anxiety, and negative emotions in a safe way. By alternating tightness and relaxation in the muscles during the use of stress relief toys, we can reduce muscle tension caused by stress and relax.



### Relaxing stretchy strings RV0200

Soft and durable strings resistant to compression and stretching. They can be used during playtime or to strengthen the arm muscles. Additionally, they might help to relieve stress and anxiety as well as improve patience. This product is especially recommended for children and adults with ADD, ADHD or on the autism spectrum.

- 6 pcs;
- age: 3+



### Relaxing hand squeezers UT0027

Relaxing hand squeezer provides many sensory experiences. It is made of flexible and resilient material which is durable and easy to squeeze. Soft, textured shapes are not only nice to

touch, but they also help children to calm down and relax. Additionally, hand squeezers strengthen the hand muscles.

- 4 pcs: ball, heart, star, oval;
- dim.: 5-8 cm;
- material: thermoplastic polyester elastomer, age: 1+

### Sensory bubble disc RV0039

Bubble sensory disc in different shapes made of silicone. Bubbles make a pleasant noise when pressed. Discs can also be used when playing in pairs.

- age: 3+



### Relaxing sensory hand squeezers

#### RV0060

Set of hand squeezers filled with liquid containing glitter. The toy's surface is smooth and slick which makes it challenging to keep in hand. These relaxing and manipulative hand squeezers train hand motor skills, stimulate creativity, relax, and help to calm down. Perfect for rehabilitation or SI therapy.

- 4 pcs;
- dim.: 12,5 x 3 x 3 cm;
- age: 3+



### Sensory cactus

#### UT0026

Set of silicone rings with wooden base. The goal of the toy is to create a colourful cactus. Each side of the sensory element has a different kind of sensory dots which encourage children to study their surface and to express their ideas through play. All rings have a special indentation in order to easily combine the elements of the set. This toy is made of coloured and textured materials to stimulate the sense of touch and sight.

- 9 pcs: 8 sensory elements, diam.: from 7,5 cm to 9,3 cm, 1 base, diam.: 10 cm;
- material: silicone, wood; age: 2+



### Textured pads in a bag

#### UT0030

Set of 10 pairs of square patches with various textures. Each patch is different, and this trait allows children to engage in sensory play through matching, discovering and describing their textures. The set includes a bag inside which children can not only store patches, but also introduce an element of randomness to their playtime. The activity with the set provides many sensory experiences, it improves concentration and focus in children, and enriches their vocabulary.



- 20 pcs;
- dim.: around 5 x 7,5 cm;
- material: 2 x polyurethane, 2 x nylon; 2 x non-slip fabric, 2 x satin, 2 x wool, 2 x plush, 2 x fabric with embossed stripes along the fabric, 2 x terry cloth, 2 x Velcro material, 2 x shiny fabric;
- filling: cut pieces of EVA foam, cotton;
- age: 1+



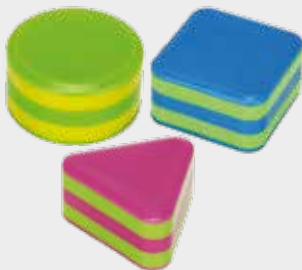

**Geometric rattles  
NT0150**

Set of rattles which stimulate the sense of hearing. All instruments in various colours and shapes produce different sounds. Perfect for playing and discovering the world through the senses of touch, hearing and sight.

- 3 pcs: shapes: square, triangle, cylinder;
- dim.: 5 x 2,5 x 5 cm; material: plastic;
- age: 12 months +



**Sensory bricks  
US0529**

Construction elements for building various structures. Sensory bricks can be arranged freely one on top of the other. Playtime with bricks helps to develop small motor skills and spatial imagination. Different textures of the elements additionally stimulate the sense of touch.

- 32 pcs, 4 shapes and 4 colours;
- material: plastic;
- age: 3+



**MIRRORS**



**Mirror shapes. Set  
NS9080**

The set of mirrors in four different shapes. They are perfect for speech therapy exercises, games developing self awareness and the sense of observation in a child. Acrylic mirror glass permanently placed in a frame with rounded edges is safe for small hands.

- 4 pcs;
- dim.: 15 x 15 x 1,2 cm;
- shape: triangle, circle, square, hexagon;
- material: MDF board, 12 mm thick, acrylic mirror glass



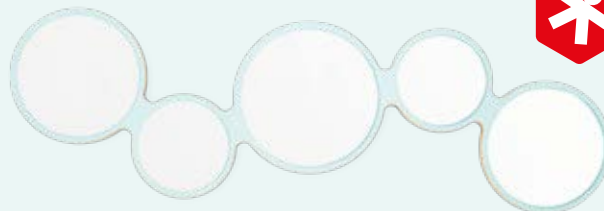

### Speech therapy mirrors NS0364

The set of 5 mirrors on a shared surface. Mirrors were made of safe, solid and scratch-resistant plastic. It is a perfect tool for toddlers because it provides reflective experience of their own bodies or of various objects in the therapy of sensory integration

disorders. It can be also useful during speech therapy exercises. The set contains mounting hardware for hanging it on the wall.

- 1 x mirror with hooks;
- 2 x screws (6 x 6 cm; with wall plugs);
- dim. of the set: 100 x 30 cm;
- diam. of the mirrors: 1 x 23 cm, 2 x 22 cm, 2 x 15 cm;
- material: MDF board, 12 mm thick, in green colour, 2 mm thick mirror plexiglass



### Wall mirror with an arm and manipulative elements NS9093

A mirror with a bar on which are fixed movable colourful shapes (circle, pentagon, hexagon and heptagon). The mirror frame is made of MDF board.

- dim.: 49 x 49 x 16 cm

### Mirror tray NS9089

The tray has a mirror on the bottom. The walls are made of MDF board.

- dim.: 40 x 30 x 6 cm

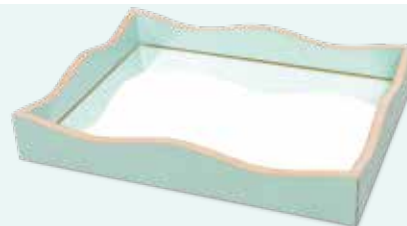



**Mirror 2**  
**NS3063**

- size: 25 x 25 cm; wooden frame



**Reflective box**  
**NS0551**

- a box lined with two plexiglass mirrors + 1 mirror

**Mirror with handles**  
**NS0568**

- size: 35 x 23 cm;
- material: MDF frame, plexiglass mirror





# PLAYING AREA

## SOFT PLAY CORNERS



### Foam House

#### NS2223

This colourful house is ideal for play both indoors and in a playground or garden. The elements of the house are covered with durable, easy-to-clean printed PVC fabric and filled with high-density foam for lightness and

easy assembly. The whole construction is rigid and stable thanks to Velcro fastening. The floor element guarantees perfect insulation from the ground.

- dim.: 110 x 120 x 127 cm;
- mattress: 85 x 122 cm;
- printed elements



door & windows

strong velcros

printed elements

covered with durable PVC fabric



**Foam play tunnel with mirrors and curtain. Set NS2241**

A set of colourful attractive shapes for play, whole-body training, creating obstacle courses and making spatial constructions. All the elements are made of soft foam for safety. The modules have been covered with PVC fabric in different colours. They are ideal for creches, nurseries, preschools, playgrounds and kids corners. Using foam blocks develops mobility, fitness and good posture. Besides, it simply provides fun and arouses positive emotions.

The set contains 6 elements:

- 1 tunnel playhouse with a curtain (92 x 60 x 74 cm; mirror D 18 cm, velour circle D 27 cm, materials: green, white and grey PVC, yellow velour, plastic);
- 1 tunnel playhouse with mirrors (92 x 60 x 74 cm, mirror D 18 cm; materials: blue and white PVC, plastic);
- 2 mattresses with mirrors (100 x 5 x 60 cm, mirror D 18 cm, material: white, green and blue PVC, plastic);
- stairs (60 x 40 x 20 cm, material: white, green and blue PVC, plastic);
- ramp (60 x 40 x 20 cm, material: blue PVC)

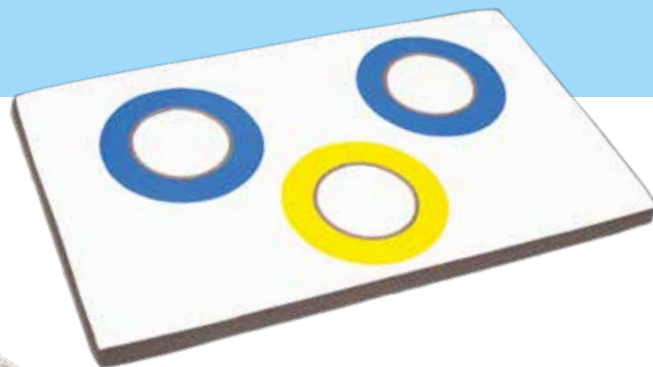

**Mattress with mirrors NS2240**

This soft mattress with 3 mirrors in coloured frames ensures safe and comfortable activity for the youngest, as well as stimulating a child's sight. Covered with white easy-to-clean PVC fabric.

- dim.: 100 x 5 x 60 cm;
- mirror D 18 cm;
- material: PVC in white and green, blue, plastic





### Playhouse with curtain NS2238

A foam tunnel-shaped playhouse is an ideal place for themed and gross motor activities. It can also serve as a rest corner. The necessary privacy is ensured by a two-coloured curtain. All the elements of the house are made of foam covered with easy-to-clean PVC fabric. The side walls have a velour circle and a mirror.

We also offer a house in blue colour in which the sensory circle has been replaced with another plastic mirror.

- dim.: 92 x 60 x 74 cm;
- mirror D 18 cm;
- velour circle D 27 cm;
- materials: PVC (green, white and grey);
- yellow velour

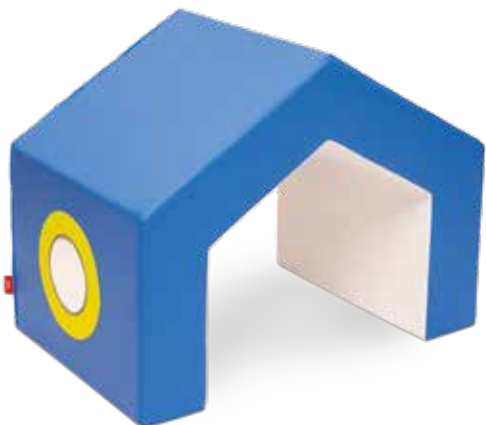
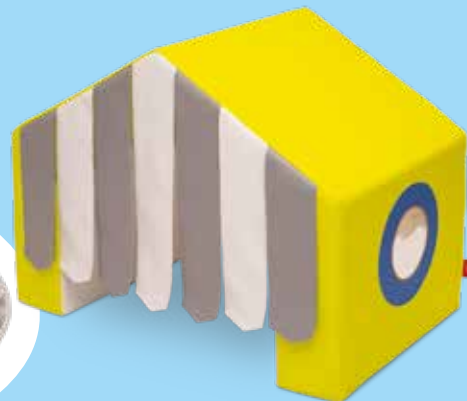

### Playhouse with mirrors NS2239

A foam tunnel-shaped playhouse is an ideal place for themed and gross motor activities. It can also serve as a rest corner. The necessary privacy is ensured by a two-coloured curtain. All the elements of the house are made of foam covered with easy-to-

clean PVC fabric. The side walls have a velour circle and a mirror. We also offer a house in blue colour in which the sensory circle has been replaced with another plastic mirror.

- dim.: 92 x 60 x 74 cm;
- mirror D 18 cm;
- materials: PVC in blue and white, plastic

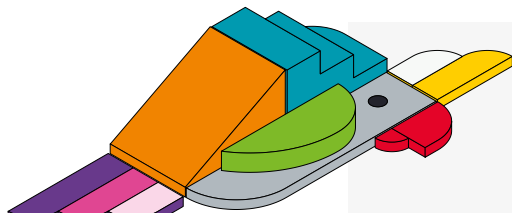

**Gymbox Parrot**  
**NS2192**

Softplay obstacle course for young children consisting of 7 elements: mats, ramp and stairs that assemble into a design resembling a parrot. Elements with velvet covers: tail, wing and top of the head. Other elements are made of phthalate free PVC with anti slip surface on the bottom

- to be used under adults supervision;
- age: 2+



Dimensions:

- 1** 60 x 45 x 5 cm
- 2** 60 x 45 x 36 cm
- 3** 60 x 45 x 36 cm
- 4** 45 x 30 x 5 cm
- 5** 37,5 x 20 x 5 cm
- 6** 70 x 25 x 10 cm
- 7** 120 x 30 x 50 cm





**Mirror triangles.**  
**Foam obstacle course**  
**NS2263**

The obstacle course consists of modules which, when connected, form a circle and a flower. The whole construction is stable thanks to Velcro fastening. The course is ideal for activities developing gross and fine motor skills. It is additionally equipped with foil mirrors to stimulate sight

- 6 modules 42 x 264 x 20 cm when connected;
- foil mirror diam. 28 cm;
- colour: blue, green, white, yellow, azure, grey;
- material: PVC, foam



strong velcros



safe foil mirrors



## REHAB TRACKS FOR TODDLERS

Foam shapes designed especially for toddlers who want to engage in more active playtime. With the foam shapes, it is possible to create safe and varied obstacle courses. They provide space for playtime or

rehabilitation exercises for children in need of special care, or additional sensory stimulation. In our offer, you can find 4, 5 and 9 module proposals in a set. All foam shapes are made of phthalate-free PVC fabric

which is easy to clean. They are filled with polyurethane foam with increased density. It ensures comfort and durability. The non-slip bottom of the foam elements guarantees safety during exercise and play.



### Set of 9 NS3420

- the set contains 9 elements;
- polyurethane foam; grey non-slip fabric;
- material: PVC fabric

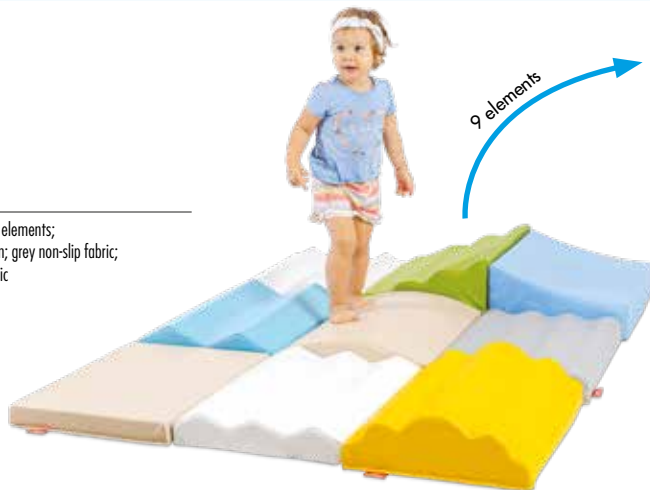

9 elements



Wedge

• dim.: 60 x 39 x 20 cm



Wave ramp

• dim.: 60 x 39 x 20 cm



Wave

• dim.: 60 x 39 x 5 cm



Flower

• dim.: 60 x 39 x 14 cm



Hillock

• dim.: 60 x 39 x 10 cm



Houses

• dim.: 60 x 39 x 12 cm



Hill

• dim.: 60 x 39 x 10 cm



Half wave

• dim.: 60 x 39 x 9,5 cm



Mattress

• dim.: 60 x 39 x 5 cm



### Set of 5 NS3418

- dim.: width: 60 cm; depth: 39-40 cm;
- height: 5-20 cm;
- cover: phthalate-free PVC fabric resistant to abrasion;
- filling: high resilience polyurethane foam; 5 elements



5 elements



Hillock

• dim.: 60 x 39 x 10 cm



Mattress

• dim.: 60 x 39 x 5 cm



Houses

• dim.: 60 x 39 x 12 cm



Hill

• dim.: 60 x 39 x 10 cm



Half wave

• dim.: 60 x 39 x 9,5 cm



### Set of 4 NS3419

- the set contains 4 elements;
- polyurethane foam



4 elements



Wedge

• dim.: 60 x 39 x 20 cm



Wave ramp

• dim.: 60 x 39 x 20 cm



Wave

• dim.: 60 x 39 x 5 cm



Flower

• dim.: 60 x 39 x 14 cm



### Toddler terrace NS2117

Set of elements to make overcoming obstacles fun. The sizes of the elements and the set are adapted to the needs of the youngest. High density foam with a safe PVC cover. The elements can be arranged in numerous configurations.

- square base;
- 4 foam elements of various shapes (waves, stairs,ramps);
- 4 flat mattresses;
- set of 9 elements;
- side 140 cm, height 20 cm

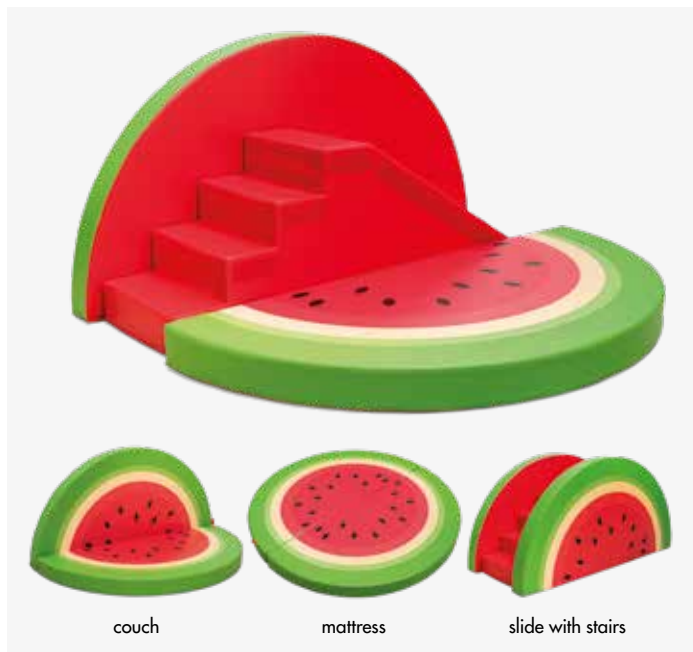
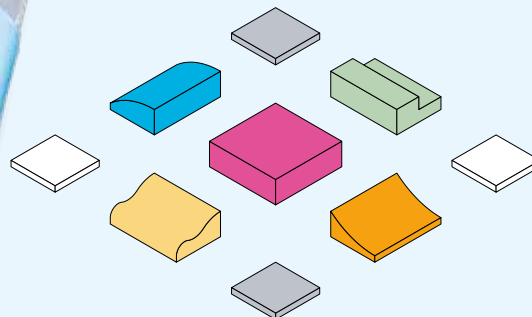

### Stairs and Slide - Watermelon NS2212

The Watermelon Slide has Velcro fastenable sides. When they are detached, the stairs can be used as

an element of an obstacle course, and the sides as two semicircular or one round play mattress.

- size: 136 x 68 x 65 cm;
- foam padding, printed PVC cover;
- both sides velcro-fastenable

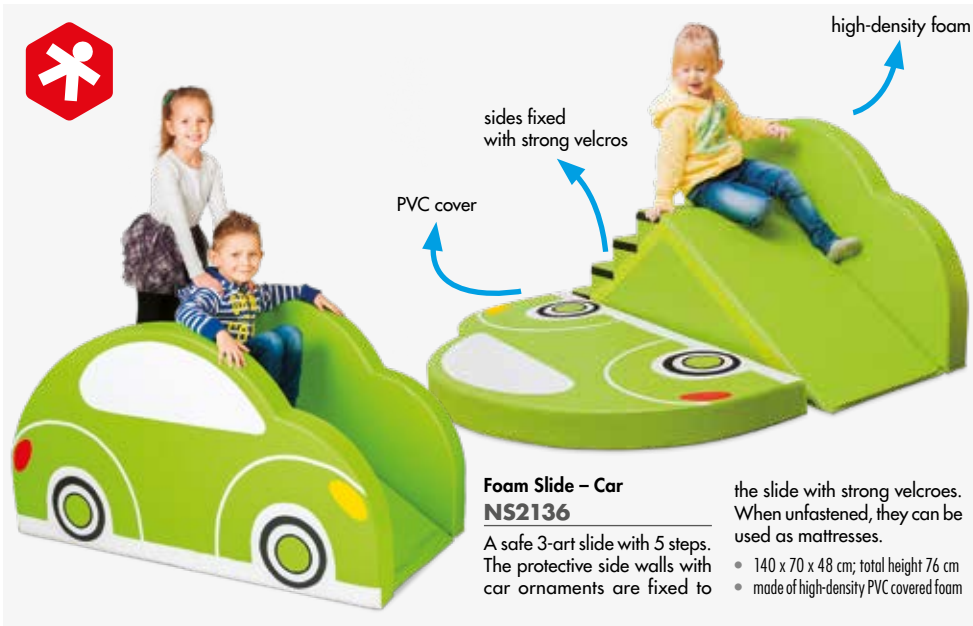

**Foam Slide – Car  
NS2136**

A safe 3-art slide with 5 steps. The protective side walls with car ornaments are fixed to

the slide with strong velcros. When unfastened, they can be used as mattresses.

- 140 x 70 x 48 cm; total height 76 cm
- made of high-density PVC covered foam



**Traffic lights  
NS2135**

Ideal for playing and learning the traffic rules about crossing a street. The lights are velcroed and so children can arrange them on their own in the right order.

- size: 20 x 20 x 60 cm; made of PVC covered foam



**Bridge - cloud  
NS2222**

The bridge consists of 3 velcro-fastenable elements (2 sides and the inside). PU foam padding for durability and comfortable use.

- size: 180 x 92 x 74 cm;
- made of PVC covered foam

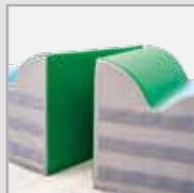

velcro fastening

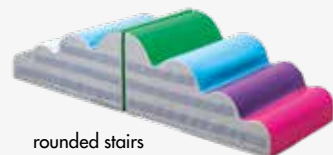

rounded stairs



couch

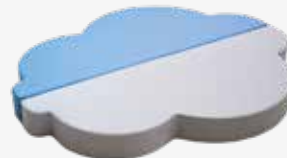

mattress





**Softplay activity lounge  
NS1931**

Soft & safe play corner is a real encouragement for spontaneous play and activities involving movement. Joyful colours combined in an interesting way introduce a friendly environment and turn the play corner into a favourite fun place.

- total dim.: 156 x 156 x 32 cm



**Foam Corner  
NS2178**

Velcro-connected foam seats and mattresses.

- 2 long beams, 2 corners (H 25 cm),  
4 mattresses 100 x 100 cm;
- total dim.: 200 x 200 cm



# CASTLE

## NS1904

A set of softplay modules to build three-dimensional constructions and to form long mats. An aid in engaging logical and spatial reasoning.

- 12 pcs;
- made of foam covered with PVC fabric;
- designer Olga Rogalska

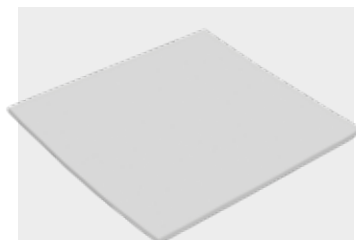
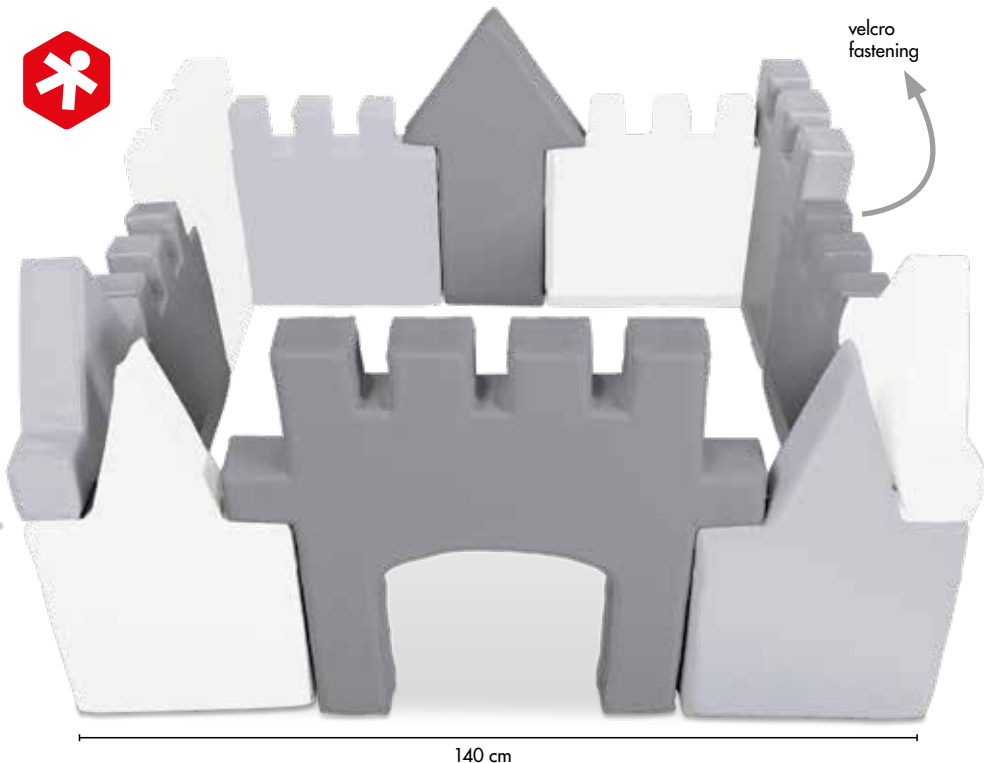

## Mat for the Castle NS1888

An accessory for Castle.

- dim.: 140 x 140 x 2 cm

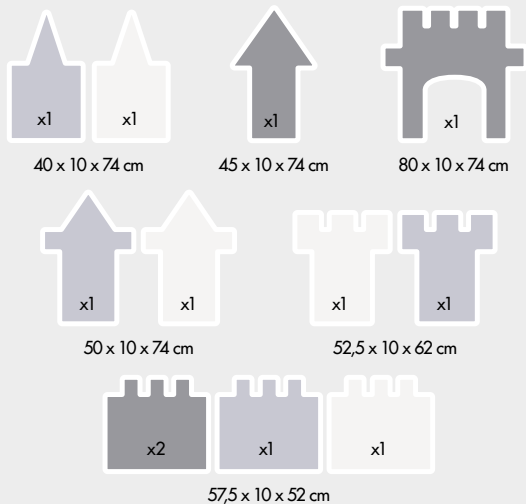



### Pastel playpen with manipulative elements BT0015

A functional playpen. Its shape can be adapted to fit one child or a group of children. The design gives the possibility of having fun while observing the surroundings in a secure environment. One of the two bigger pieces takes the form of a gate with an external lock while the other is equipped with six manipulative elements. The set includes construction stabilizers covered with a layer of non-slip material which ensure the stability of the playpen.

- 10 elements: 2 pcs, dim.: 74 x 65 cm (a round gate, a board with manipulative elements);
- 8 pcs, dim.: 43 x 65 cm, 10 construction stabilizers;
- material: plastic



### Royal playpen BT0014

A functional playpen which provides a safe space for one toddler or a small group. Thanks to its openwork design a child can simultaneously play and watch the surroundings. One of the two larger elements is a safe gate with an external protection, the other offers six manual activities. The set has bottom-mountable stabilizers with non-slip material

- 16 elements:  
2 - 79,5 x 3,5 x 70 cm (gate, manipulative panel),  
8 - 38 x 3,5 x 70 cm,  
6 - stabilizers; colour: white and grey;
- material: plastic



### Foldable Playpen FB0005

The mesh walls guarantee proper ventilation and constant eye contact. The added plus is a pocket for toys and an openable wall for easy access to the child and for easy exit/entry.

- dim.: 100 x 100 x 80 cm, weight 10 kg;
- very easy assembly and dismantling;
- small size when folded;
- a handy bag for easy carrying

## INDOOR PLAYGROUNDS

### Activity corner Metro NS9072

A mini play area oriented toward children's all-round development. It provides many attractive activities which cater for the needs of toddlers. The activity corner has two levels, stairs, a plexiglass window and a slide. There is also some space to hide when playing hide-and-seek. For those who like manipulating there are cogwheels and motor mazes. The product is for use indoors, requires assembly and is not permanently attachable to the floor.

- dim.: 121 x 121 x 127 cm;
- material: painted playwood, MDF board, plexiglass

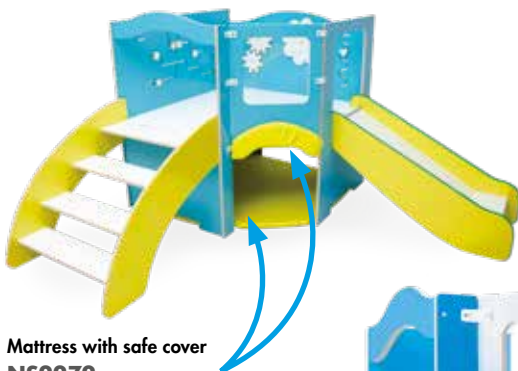

### Mattress with safe cover NS2272

- for the playground Metro;
- size: 115 x 115 cm;
- material: PVC





### Play corner meadow NS9161

Corner play area which serves as an indoor playground. Sensory and motoric elements make children more willing to use the slide to which you have to climb the climbing wall. The playground depicts a meadow both above and below the ground.

- size: 236 x 252 x 198,8 cm;
- hide-out with mattress and manipulations on walls;
- slide;
- mirrors;
- window;
- climbing handles;
- manipulative mazes



### Mattress for the Meadow play corner NS2201

- dim.: 185 x 120 x 2 cm;
- cover: phthalate-free PVC fabric, resistant to abrasion;
- the underside is made of non-slip textured PCV fabric;
- filling: high resilience polyurethane foam;
- the mattress complements the Meadow play corner (NS9161)



### Island and Pirates Ship NS9180

The free-standing, internal playground with many sensory and motor elements. Developing not only motor coordination. The playground consists of the island and its underwater part. The second element is a ship with a steering wheel and an anchor.

- play possible on and under the deck;
- dim.: 550 x 340 x 240 cm;
- climbing wall with stone holds;
- tube slide;
- 2 x maze;
- turnable elements;
- steering wheel;
- mobile anchor;
- 2 x turnable jigsaw;
- slide;
- ladder;
- climbing net;
- pull-up bar;
- climbing wall with holes;
- steps



### Mini pirate ship. Indoor playground NS9190

Stand alone playground with many sensory and motoric elements. The construction is made of varnished playwood with printing.

- slide;
- ladder;
- climbing wall;
- elements for manipulation;
- steps with print;
- movable steering wheel;
- dim.: 393 x 176 x 243 cm

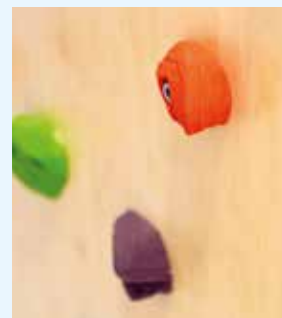
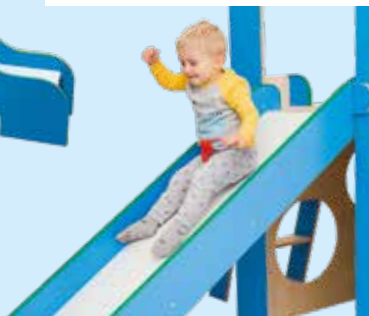

# SENSORY BALLS



**Sensory ball set  
NS2068**

A set of 10 sensory balls:

- bead ball;
- 3 x foam balls;
- 2 x rugged balls;
- cube ball;
- circus ball;
- 2 x spider balls;
- textile bag





35 elements



### Large sensory set

#### NS2083

A set of various elements of interesting shapes and textures. Excellent in foot correction, massage or sensory integration therapy. They help improve motor skills and hand-eye coordination.

- 35 elements:
  - 1 sensory ball with pyramid-shaped spikes (D 16 cm),
  - 1 rugby shape spiky ball (D 24 cm),
  - 1 spiky ball with beads (D 10 cm),
  - 1 sensory metallic ball (D 17,5 cm),
  - 1 spiky ring (D 17 cm),
  - 1 spiky ball (D 20 cm), uninflated,
  - 4 small balls (incl 2 with bells), D 9,3 and 7,3 cm,
  - 6 sensory bags in different shapes: triangle, rectangle, cube, rhomb, filling: plastic pellets,
  - dark blue embroidered drawstring bag 21 x 25,5 cm,
  - 2 juggling balls (filled with mustard seeds, D 5 cm),
  - 1 sensory maze - snail with balls, D 24 cm,
  - 1 sensory pirates wheel D 27 cm,
  - 2 thin massage rollers (D 11 cm, T 3,5 cm),
  - 1 massage roller D 6 cm, L 15 cm,
  - 4 small sensory hemispheres D 9 cm (green, yellow, blue, orange),
  - 4 massage balls (2 red balls D 8 and 10 cm + 2 yellow balls D 8 and 10 cm),
  - 1 spiky massage ball D 8 cm, uninflated,
  - 1 quoit with beads D 18 cm,
  - 1 mini medicine ball D 18 cm,
  - 1 storage bag D 37 cm, L 55 cm



### Sensory shapes in a sack

#### US0509

A set of sensory aids of different shapes and textures providing different tactile sensations

- 12 shapes in a nylon bag;
- age: 3+



**LG0285**

- ø 85 cm;
- max load 300 kg

**LG0265**

- ø 65 cm;
- max load 300 kg

**LG1240**

- ø 40 cm
- max load 150 kg

**Massage ball  
LC9752**

- ø 28 cm

**MASSAGE GYM BALLS****LG1208**

- ø 8 cm

**LG1212**

- ø 12 cm

**LG1210**

- ø 10 cm

**LG1218**

- ø 18 cm

**- Set  
LG1201**

- 2 x ø 8 cm; 2 x ø 10 cm

For massaging, rehabilitation and sensory integration. They help lower muscle tension and eliminate pain. The soft spikes stimulate sensory receptors and the circulatory system.

**RUBBER MASSAGE ROLLERS****Thin  
US0261**

- 2 pcs;
- D 3,5 cm, L 11 cm

**Spiny  
LG1202**

- ø 6 cm, L 12 cm



**Aero Massage Ball**  
**FI0052**

- ø 17,5 cm

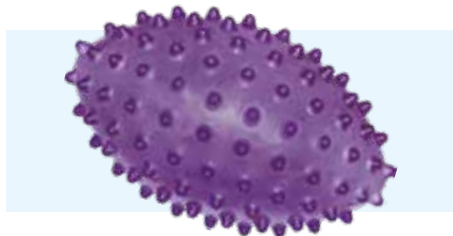

**Spiky football**  
**US0059**

- ø 24 cm

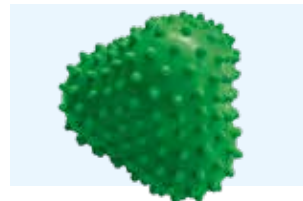

**Spiky pyramid ball**  
**US0335**

- ø 16 cm

**Spiky crystal balls**  
**US0044**

- ø 15 cm; set of 6 colors

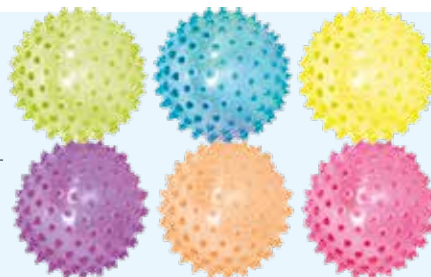

**Soft sensory blocks**  
**RV0034**

Colourful blocks promote the development of motor skills in children. They allow them to train the eye-hand coordination, practice colour/number/shape recognition as well as engage other senses. The different textures of

animals and numbers provide many sensory impressions. The material from which the blocks are made of is bisphenol free. It can be subjected to sterilization processes or boiling.

- 10 pcs; dim.: 5,5 x 6 cm;
- material: plastic;
- age: 6 months +



**Pastel sensory balls. Set**  
**RV0070**

Eye-catching soft balls of various shapes and textures. They are perfect for babies and toddlers for improving motor and manipulative skills or for stimulating the sense of

touch. These balls are crush and water resistant. They are made of BPA free material.

- 6 pcs; diam.: around 6,5 cm;
- 6 pastel colours: yellow, purple, 2 shades of green, blue, nude;
- material: silica gel;
- age: 6 months +

**Textured rubber balls**  
**UT0038**

Set of soft, rubber sensory tools intended for sensory integration exercises and manipulative playtime. Each tool has a different design, structure and colouring in order to stimulate the child's senses. The product is intended for contact with water.

- 8 pcs:  
sea urchin dim.: 7 x 7,5 cm; melon dim.: 6,5 x 6,5 cm;  
bread dim.: 4,5 x 5,5 cm; cookie dim.: 5,5 x 6 cm;  
cheese dim.: 5 x 5,3 cm; honeycomb dim.: 6,5 x 7,5 cm;  
flower dim.: 3 x 6,5 cm; carrot dim.: 4 x 7,5 cm;
- material: plastic;
- age: 1+





**Bead ball**  
**US0223**

Transparent soft rubber ball stuffed with beads. Easy to throw and grip.

- ø 9 cm



**Spiky ball with pellets**  
**US0011**

transparent sensory ball

- ø 10 cm



**Senso reaction ball**  
**US0478**

• ø 10 cm



**Fruit Shakers**  
**US0022**

Set of 3 sensory balls: apple, pear and orange.

- 3 pcs; ø 8 cm



**Bear print ball**  
**US0025**

• ø 20 cm, soft vinyl material



**Foam Playground ball 7'**  
**US0064**

• ø 18 cm



**Goal ball**  
**US0274**

• ø 21 cm



**4 Jingle balls**  
**US0006**

- jingle airflow ball 9,3 cm; jingle airflow ball 7,3 cm;
- perforated ball 9,3 cm; perforated ball 7,3 cm



**Sheep balls**  
**VX7504**

Made of synthetic fabric cover and filled with acrylic polyfil. Looks like a fleece ball.

- ø 7,5 cm; set of 4 (red, yellow, blue, green)



**Fun sports balls**  
**VX0327**

Balloon cover made of synthetic fabric. Looks and feels like a fleece ball. Light in weight with a lower bounce and suitable for children. Helps improve eye-hand coordination.

- ø 18 cm



**Snail Maze**  
**US0498**

A soft sensory snail whose shell serves as a maze. Between two layers of fabric there are two small balls to be pushed through the labyrinth using fingers.

- ø 24 cm;
- 3 balls, fabric: velvet;
- age: 0+



**Easy grip ball**  
**US0073**

- set of 6; ø 25 cm;
- soft vinyl material



**Tossing Ring with Beads**  
**US0033**

- ø 18 cm; made of rubber



**Sensory Donut**  
**US0055**

- ø 32 cm



## SENSORY HEMISPHERES



**Hedgehog stone big**  
**US0450**

- ø 25 cm



**Hedgehog stone small**  
**US0451**

- 4 pcs; ø 9 cm



**Sensory hemispheres**  
**LC8089**

- 6 pcs; ø 16 cm; H 8 cm

**Pineapple sensory hemispheres**  
**RV0010**

Sensory hemispheres improve dynamic balance and body awareness. They help relieve stress and improve circulation. Perfect for developing coordination, endurance and training different muscle groups. Great for massage, especially feet. Suitable for both children and adults.

- 8 pcs; wed. hemisphere: 16 cm;
- 8 colors: yellow, orange, red, green, blue, dark blue, silver, pink;
- material: plastic; age: 3+

# BALANCING DISCS



## Sensory disc – green US0521

Sensory disc can be used for balance exercises in standing and sitting position, correction of posture defects and sensory integration therapy. It relieves and strengthens the back muscles, also forcing the good posture while sitting. Equipped with special tabs which, by stimulating the sensory receptors, e.g. on the feet, relax the muscles and improve blood circulation. It is made of high-quality materials, resistant to damage and easy to clean. It is possible to inflate the disc and adjust its hardness and convexity to individual needs.

- ø 38,5 cm;
- load: up to 150 kg;
- material: vinyl;
- colour: green



## Big sensory balance cushion US0508

Ideal for whole-body stimulation, foot massage, and co-ordination and balance exercises. For use in different positions: kneeling, standing, lying and sitting. Both sides of the disc are covered with soft sensory spikes.

- D 60 cm;
- material: rubber



## Sensory balance cushion LG0684

- ø 20 cm



## Soft rubber cushion VO3188

- ø 21 cm



## Sensory wedge – red US0527

Sensory pillow in the shape of an wedge, filled with air. During sitting, it relieves lumbar spine and helps to keep the pelvis in the correct position. Additionally, it supports the processes of attention and concentration.

It can be also used for balance exercises and correction of posture defects. The surface of the pillow is covered with tabs stimulating the sense of touch.

- dim.: 33 x 33 cm;
- load: up to 150 kg;
- material: vinyl;
- colour: red



# SENSORY-BALANCED PATHS



**Balance plate**  
**UT0028**

Perfect aid to learn how to balance with the whole body or do exercises which train balance and motor skills. It is equipped with a maze with 5 balls. They allow children to develop their eye-hand coordination and dexterity. The surface of the balance beam has special non-slip dots which ensure safety during any activity.

- dim.: 50 x 40 cm;
- material: ABS;
- age: 3+



**Feet balancing board**  
**NS3104**

Hemisphere mounted on the underside, ensures fun not only for children.

- size: 64 x 41 cm; made from MDF; ages: 5+



**Penguin Rocker**  
**US0440**

- size: 60 x 13 x 11 cm;
- max. weight: 80 kg;
- ages: 3+



**Wobble board**  
**TY0006**

- ø 39 cm



**Balance trainer**  
**US0082**

An air-filled rubber hemisphere for balance exercises. You can stand, sit or lie down on it.

- base diameter 45 cm, H 22,5 cm



**Stability pad**  
**US0091**

- ø 33 cm



#### Board on the sphere CS6004

- size: 70 x 20 x 9 cm;
- made from playwood



#### Board on the cylinder CS6005

- size: 70 x 20 x 9 cm
- made from playwood



#### Skateboard on rubber balls NS9183

Wooden skateboard on 4 rubber balls. For exercising balance and coordination. Non-slip elements protect children from falling.

- size: 74 x 19,5 x 8 cm;
- maximum work load 80 kg



#### Balancing ball NS9184

Stand with both feet on the base, press the ball and start to bounce. The ball is meant for balancing and co-ordinating exercises aimed at developing quick motor reactions. The base with a non-slip surface, spiky rubber ball (placed in the base it creates two half-spheres).

- diam.: 20 cm; base 58 x 38 x 22 cm;
- maximum work load 80 kg



#### Wooden sensory path NS9071

A sensory aid made of board mounted on 6 balls. It provides various tactile sensations and stimulates sensory receptors. Stimulants for feet are 4 bags with various fillings. They are fastened to the board with velcros for quick replacement and prevent them from sliding off.

- 5 elements: board 125 x 24 x 10 cm; 4 bags 14 x 25 cm;
- materials: playwood varnished, fabric;
- filling: fine gravel, upholstery foam offcuts, styrofoam chips, plastic pellets D 3mm

### Balancing path on rubber balls

This aids consists of a platform embedded on rubber balls. It is used for balancing and it has a positive influence on the development of the vestibular system, awareness of the body and control over it. The product is ready to use and no assemblage is necessary.

- maximum work load 80 kg;
- material: plywood, 15 mm thick, plastic



### Straight NS9182

- dim.: 74 x 36 x 8 cm



### Zig-zag NS9187

- dim.: 74 x 54 x 8 cm



### Arch NS9189

- dim.: 68 x 57 x 8 cm;
- arch 60 degrees



### Arc NS9186

- dim.: 74 x 74 x 8 cm;
- arch 90 degrees







### Walking Buckets VX0006

Balancing Stepping Buckets made of strong plastic. These buckets are connected by a braided nylon rope for increasing or decreasing the distance between the buckets.

- set of 6 (red, yellow, blue, green, orange, purple);
- size: 12,7 x 30,5 cm



### Walking Tubs VX0007

Made of strong plastic. These tubs are connected by a braided nylon rope for increasing or decreasing the distance between the buckets.

- set of 6 (red, yellow, blue, green, orange, purple);
- 4 pcs straight and 2 pcs incline/decline;
- stackable for easy storage

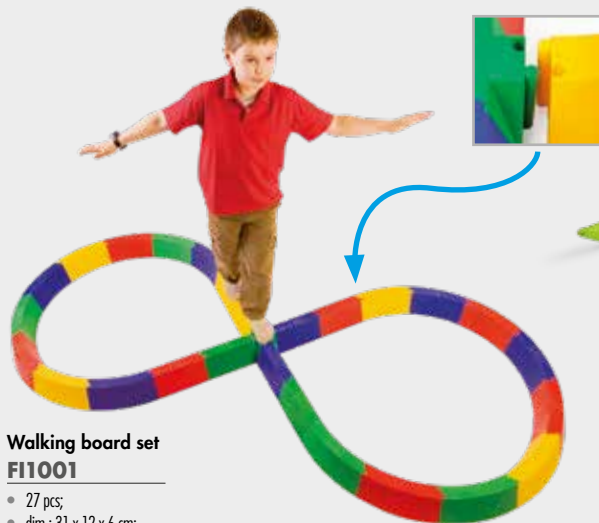

### Walking board set FI1001

- 27 pcs;
- dim.: 31 x 12 x 6 cm;
- material: plastic



### Snake. Soft balance path UT0049

A colourful snake designed to help in balance training. By walking on the „squirming“ snake, children develop the sense of balance and strengthen the muscles of the feet preventing flat feet.

- length: 220 cm;
- outer material: polyester fabric;
- filling: polystyrene granules;
- age: 3+





**Hop Paws  
BO2305**

Paw shaped foam platform equipped with long ropes and soft handles designed for jumping.

- dim.: 56 x 32 x 2,9 cm;
- length of the ropes: 70 cm;
- material: EVA foam, plastic
- age: 3+



**Mini stilts  
AS0027**

- H 12,5 cm, ø 13,5 cm



**Balancing cone  
JN0180**

Balancing cone helps to improve posture, balance and coordination. It allows children to practice and strengthen their sense of balance, it also teaches motor and hand-eye coordination.

- diam. 25 cm, H 22 cm; material: plastic; age: 3+

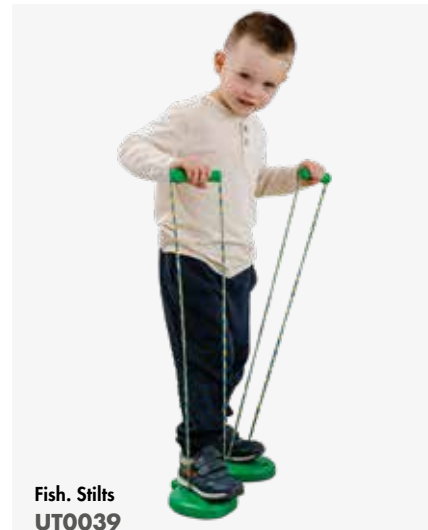

**Fish. Stilts  
UT0039**

Fish-shaped stilts. Perfect aid in training the hand-foot coordination as well as the balance. They are made of durable plastic.

- colour: green;
- dim.: 21 x 15,5 x 8 cm; age: 3+



**Sensory stilts  
US0271**

- H 7 cm, ø 13 cm



**Pogo jumping stick**  
**BO0011**

Pogo jumping stick in vivid colours. It is made of foam. Perfect for playing, exercising or competing.

- age: 3+



**Balance roller with handle**  
**MK0403**

- size: 34 x 40 x 64 cm



**Platform on wheels**  
**NS2902**

- size: 41 x 30,5 cm;
- panel thickness: 1,8 cm



**Maxi roller**  
**JG2138**

- size: 34 x 40 cm



**Caterpillar**  
**NS1598**

- L 3,5 m, W 12 cm, 16 handles

**Caterpillar XL**  
**NS1657**

- L 6,5 m, W 12 cm, 28 handles





**Sensory path**  
**NS2089**

Sensory path constructed of square panels, each filled with plastic balls. It is made of different materials in pastel colours. The edges of the panels were secured with grey trimming. Elements of the set are an excellent tool for stimulating and developing the sense of touch. Squares can be examined with hands or the children can walk on them. They are also perfect for corrective gymnastics and as elements of the obstacle course.

- 6 pcs in different colours;
- dim.: 40 x 40 cm;
- material: polyester;
- filling: plastic;
- age: 3+



**Sensory floor panels**  
**NS9084**

The set of sensory boards for stimulation of the sense of touch. It allows the teacher to organise various fun activities engaging the feet. Exercises with the set have a positive effect on balance, eye-hand-leg coordination and spatial awareness. Boards have rounded edges and attached sensory elements made of materials which provide various tactile stimulation. They can be especially useful in working with children with sensory hypersensitivity.

- 6 pcs; dim.: 25 x 25 cm;
- material: HDF board, 6 mm thick, non-slip PVC fabric in grey, navy blue for fabric, yellow plush fabric, green artificial grass, coconut fibers, Minky in sea turquoise colour;
- age: 3+





### A walk across the river.

#### Sensory path

#### US0503

The set of elements resembling wooden log and a water lily. This set enables the construction of a sensory path or obstacle courses as well as inspires fun activities developing hand-eye coordination. Exercising on the path develops balance, coordination, dexterity and self-confidence. Filled with different kinds of materials stimulating the sense of touch.

- 2 small lilies, dim.: 33 x 30 cm,
- 1 small lily, dim.: 23 x 21 cm,
- 2 short logs with dim.: 43 x 22 cm,
- 1 long log, dim.: 55 x 22 cm
- material: polyester, vinyl, foam;
- surfaces can be cleaned with room temperature water;
- age: 3+



### Sensory clouds - textured cushions

#### NS2231

Individual elements have been made from a characteristic, nice-to-the-touch material in a different colour. These cushions are ideal as a therapeutic tool, in bad posture correction or in sensory integration. They excellently stimulate touch and sight.

- 6 pcs;
- dim.: 45 x 36 cm;
- colours: blue, light grey, grey, yellow, green, orange
- material: Oxford cloth, drill, velour, PVC fabric, PVC, Minky fabric;
- filling: foam, styrofoam balls, glass balls



Sensory paths are made of safe, durable, and resistant materials. These aids were designed not only for toddlers learning to take their first steps but also for older children to prevent and correct foot deformities or misalignments. During therapy, they will be perfect for the development of sensory integration. Each piece has

a different hardness and form what gives the possibility to arrange them easily like puzzles. Reinforced rims stabilise the elements' surface and prevent them from sliding apart. Every set includes a guide with examples of exercises prepared by qualified orthopaedists and physiotherapists.

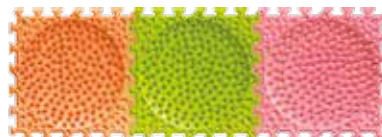

### Island sensory path

#### OT3000

Soft puzzles are intended for prevention of flat feet, correction of valgus knees, development of the sense of balance, and improvement of motor coordination. In the middle of each piece there is an „Island“ covered with massaging spikes which

stimulate plantar muscles. The exercises on the path strengthen the muscles and ligaments of the ankles and lower legs, stimulate reflex zones of the feet, reduce fatigue, and improve circulation

- 3 pcs; dim.: 25 x 25 cm;
- material: PCV;
- age: 2+



### Colourful sensory path

#### OT3002

The guide is recommended for children who have already learnt to walk. The exercises strengthen the muscles of the feet as well as prevent and correct flat feet. The sensory path stimulates

reflexogenic zones, reduces fatigue and improves overall well-being. Colours of the path encourage children to use it and have fun with it.

- 8 pcs; dim.: 25 x 25 cm;
- material: PCV;
- age: 18 months +



### Pastel sensory path

#### OT3001

Soft textures of the puzzles help to develop motor skills and dexterity in toddlers. Pastel colours relieve stress, and they have a positive effect on concentration. The exercises on the path strengthen the muscles of the feet as well as prevent

and correct flat feet. The sensory path stimulates reflexogenic zones, reduces fatigue and improves overall well-being.

- 8 pcs;
- size: 25 x 25 cm;
- material: PCV;
- age: 1+

## SENSORY PATH

Sensory panels in the form of puzzles. Each piece has a different texture stimulating the proprioceptive sense. They can be combined to create a sensory path.

- dim. of a single panel: 30 x 30 cm
- material: plastic
- age: 2+



**Sunny garden**  
**OT3004**

- 6 pcs

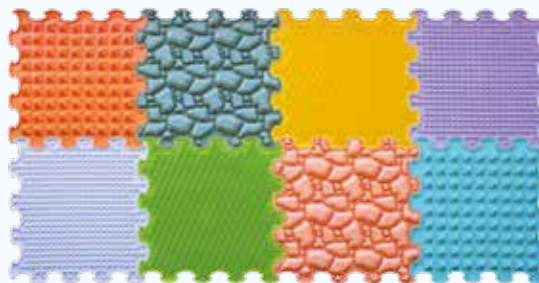

**Nature**  
**OT3003**

- 8 pcs

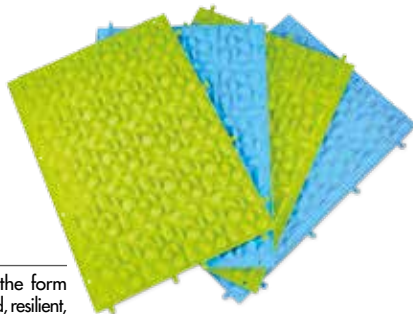

**Soft sensory paths**  
**UT0029**

Sensory path with the texture in the form of small irregular stones. Two-coloured, resilient, and light panels which can be easily connected thanks to the holes and snap rivets located at the edges of each element. The set allows children to develop sensory integration, it massages the feet and helps to correct flatfeet.

- 10 pcs: 5 green elements, 5 blue elements;
- dim. of the panel: 39 x 29 cm;
- material: thermoplastic rubber – TPR;
- age: 3+



**Sensory flat shapes.**  
**Big and small. Set**  
**UT0022**

Sensory mats for therapy or playtime in five shapes and two sizes. All big shapes have smaller round counterparts in the same colour and with the same texture. Each pair is characterised by a different pattern in order to stimulate the sense of touch of the hands and feet. They are made of durable but nice to touch material.

- 10 pcs:  
5 small shapes with the diam.: 10 cm,  
5 big shapes with the diam.: 24 cm;
- material: silicone; age: 1+



# SPORT EQUIPMENTS

## HOP BALLS

**Hippo  
hopper  
US0448**

- 20 x 54 x 35 cm;
- seat height: 22 cm



**Leo the Lion  
hopper  
US0449**

- 22 x 54 x 35 cm;
- seat height: 22 cm



**Bounce ball  
Reindeer  
LG0001**

- 60 x 30 x 55 cm;
- seat height: 30 cm



**US0056**

- 40 cm;
- max load 150 kg



**LG0545**

- 45 cm;
- max load 150 kg



**LG0550**

- 50 cm;
- max load 150 kg



**LG0555**

- 55 cm;
- max load 150 kg



**LG0560**

- 60 cm;
- max load 150 kg

## MEDICINE BALLS



**LG0605**

- ø 10 cm, 500 g



**LG0610**

- ø 12 cm, 1000 g



**LG0606**

- 2000 g



**LG0607**

- 3000 g



**Rhythmic balls  
LG1117**

- 4 pcs;
- ø 17 cm;
- weight 280 g



**VO0027**

- green; 1 kg



**VO0020**

- red; 2 kg





# GYM BALLS



**LG0188**

- 90 cm

**LG0175**

- 75 cm



**LG0165**

- 65 cm

**LG0150**

- 50 cm

**LG0130**

- 30 cm

## SENSORY ROLLERS

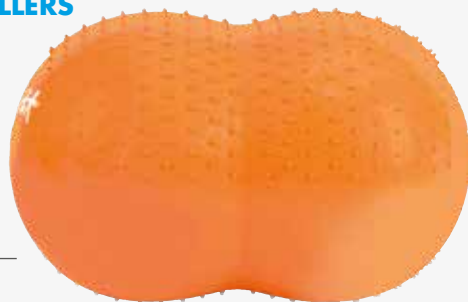

**LG0450**

- size: 90 x 55 cm;
- max load 300 kg



**LG0350**

- size: 100 x 50 cm;
- max load 300 kg

**Ball 15 cm  
LG0612**



**Volleyball 15 cm  
LG0616**



**Basketball 15 cm  
LG0615**



**Ball 23 cm  
LG0614**



**Football 15 cm  
LG0611**

- max load 150 kg



**Pogo ball  
LG0680**

- ø 40 cm



# PROFESSIONAL BALLS



**Football 6**  
**VO0035**

- size 4;
- durable, low bounce;
- hand-stitched, PU leather



**Football 7**  
**VO0036**

- size 5;
- machine-stitched, PU leather



**Football 8**  
**VO0037**

- size 5;
- hand-stitched, PU leather



**Football**  
**VO0001**

- size 5



**Street Ball 5**  
**VO0011**

- size: 5; circuit: 67 cm



**Street Ball 3**  
**VO0009**

- size: 3; circuit: 57 cm



**Handball size 2**  
**VO0038**

- size 2; for training; hand-sewn; synthetic rubber



**Handball 2**  
**VO0029**

- size 2; circuit: 54-56 cm



**Handball 1**  
**VO0028**

- size 1; circuit: 50-52 cm

## BASKETBALL

- for indoor and outdoor use
- material: formed rubber



- size 3  
**VO0004**



- size 5  
**VO0005**



- size 6  
**VO0034**



- size 7  
**VO0033**

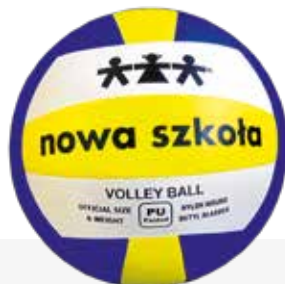

**Volleyball (size 5)**  
**VO0030**

- size 5;
- glued panels, material: micro PU

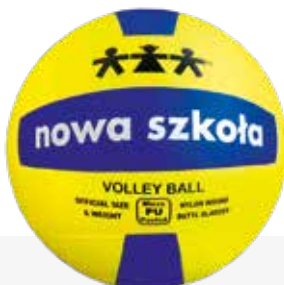

**Volleyball (size 5)**  
**VO0031**

- size 5;
- glued panels, material: micro PU



**Beach volleyball (size 5)**  
**VO0032**

- size 5;
- glued panels, material: micro PU



**Volleyball**  
**VO0003**

- size 5



**Volleyball**  
**VO0006**

- size 4



**Volleyball**  
**VO0002**

- size 1

## ACCESSORIES FOR BALLS



**Ball carrying cart small**  
**VX0100**

Carrying Cart can be folded & unfolded by a single person. Made of aluminium frame & heavy duty mesh fabric bordered with nylon coloured fabric on top, and comes with strong non marking wheels.

- dim.: 60 x 60 x 88 cm;
- weight: 2 kg;
- material: aluminum, plastic;
- closed with a zipper



**Ball bag**  
**TY0011**

- dim.: 91 x 61 cm



**Timestopper**  
**TY1069**

- dim.: 9 x 5 x 2 cm



**Score board**  
**US0467**

- dim.: 60 x 22 x 30 cm



**Pump**  
**LG1002**

- 2 needles: metal and plastic

## SOCCER EQUIPMENTS

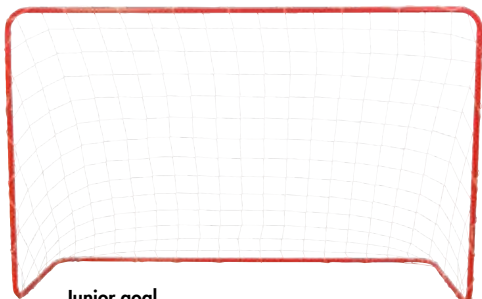

**Junior goal  
BO2102**

- dim.: 180 x 60 x 120 cm

**Soccer goal  
BO2040**

- dim.: 300 x 120 x 185 cm



## TENNIS TABLE EQUIPMENT



**Rollaway table tennis table  
BO2000**

- dim.: 274 x 152 x 76 cm;
- steel frame 30 x 30 mm and 15 x 30 mm;
- top: MDF board 12 mm;
- half the table can be folded for solo practising;
- on castors with locks



**Table tennis racket**

- 15 x 25 cm;
- rubber coating; one side smooth, one pimples;
- racket case

**5-ply blade  
BO2003**

**7-ply blade  
BO2005**



## SPORT CABINET



### without accessories NS0943A

- on wheels;
- without accessories;
- dim.: 90 x 60 x 80 cm

### with accessories NS0944A

- on wheels;
- contains different accessories (13 types);
- dim.: 90 x 60 x 80 cm



A practical box with a lid and on castors for easy storage of sports equipment indoors. Padlockable.

- dim.: 138 x 63 x 70 cm;
- sold without sport accessories



**Mobile chest for sports equipment  
ML2906**

- MDF chipboard in marmara blue and and grey

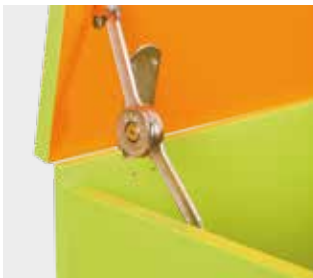

**Mobile chest for sports equipment  
NS2906**

- material: MDF chipboard in green and orange



# OBSTACLE COURSES

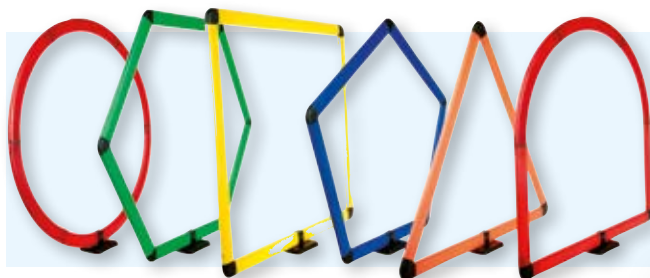

## Obstacle course TY0008

- 6 shapes; 6 stands;
- height: 67-69 cm;
- width: 67-76 cm

## Obstacle course stands TY0018

- 6 pcs for TY0008

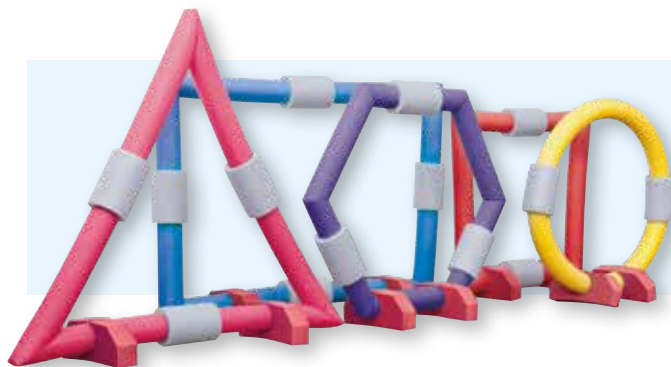

## Geo softplay shapes NS0743

- set of 5 shapes:  
square (62 x 62 cm), rectangle (105 x 74 cm), triangle (side 92 cm),  
circle (dia. 58,6 cm), hexagon (side 38 cm);
- material: EVA foam



# GYMNASTIC SETS

## Construction Forts BO1203

- pole: 45 pcs;
- ball: blue x 14pcs, green x 13 pcs

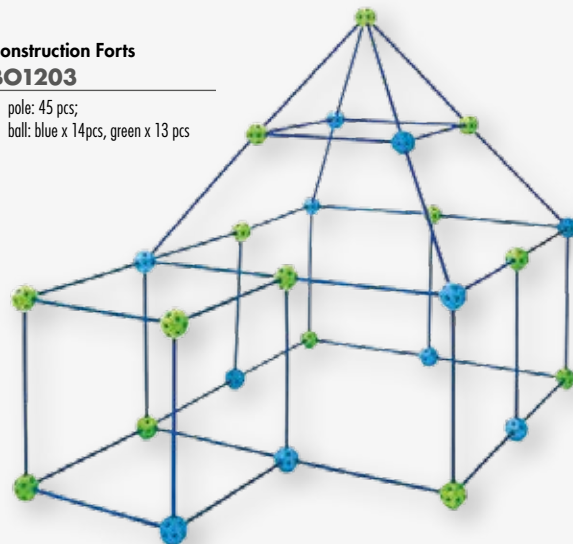

**Gym set 2  
TY0200**

- 4 cones (H 50 cm);
- 4 cones (H 30 cm);
- 8 boxes (21,5 cm, H 20 cm);
- 4 rings (ø 38,5 cm);
- 4 rings (ø 59 cm);
- 4 rings (ø 77,5 cm);
- 4 bridges (15 x 81,5 cm);
- 8 bricks (15 x 15 cm, H 9,5 cm);
- 8 bricks (15 x 36 cm, H 9,5 cm);
- 8 bars 40,5 cm long;
- 8 bars 70,5 cm long;
- 8 bars 98,5 cm long;
- 12 feet prints (= 6 pairs);
- 12 hand prints (= 6 pairs);
- 20 colourful connectors;
- 24 black clips/connectors;
- 8 blue clips



148 elements



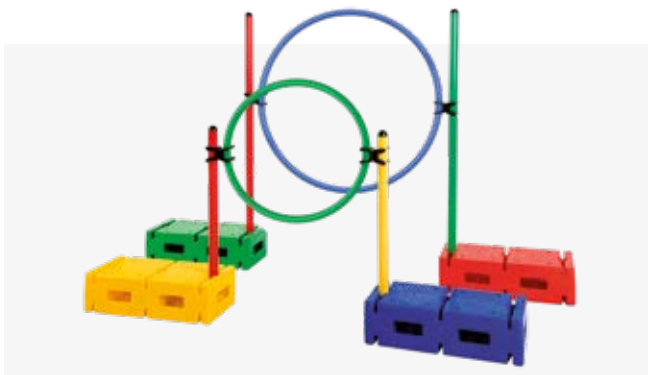

### Linking bricks FI1611

- 4 pcs;
- dim.: 36 x 15 x 9,5 cm



### Clips FI8567

- 24 pcs

## HOOPS

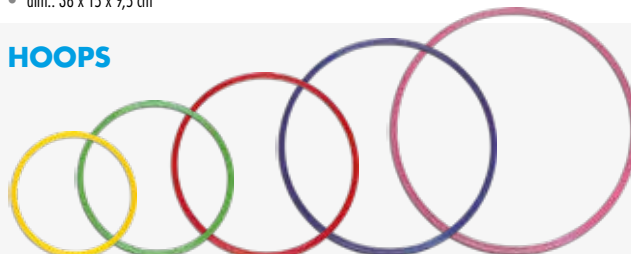

39 cm  
FI2140

- 4 pcs

49 cm  
FI2150

- 4 pcs

59 cm  
FI2160

- 4 pcs

70 cm  
FI2180

- 2 pcs

75 cm  
FI2190

- 2 pcs

## EXERCISE BARS



### FI2080

- 10 pcs; 80 cm

### FI2100

- 10 pcs; 100 cm

### FI2120

- 5 pcs; 120 cm

### FI0180

- 5 pcs; 180 cm



46 elements

### Gym set 1 FI2222

- 6 rings ø 48 cm;
- clips 24 pcs;
- 6 cones;
- 10 bars L 70 cm

### Scarves NS0127

- 4 pcs;
- size: 100 x 6 cm

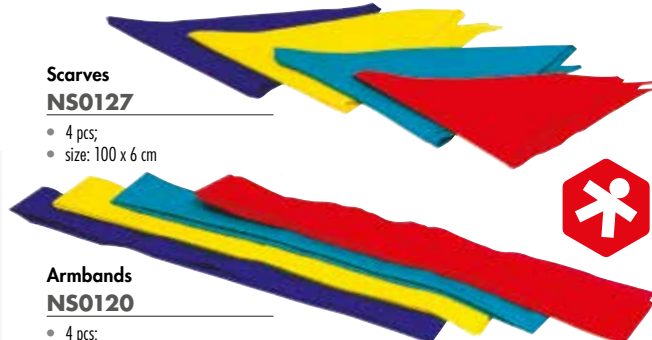

### Armbands NS0120

- 4 pcs;
- size: 11 x 5 cm

### Jumping bags set TY0117

- 6 pcs;
- size: 52 x 62 cm





**Ribbons 4 m**  
**TY0106**

- 6 pcs

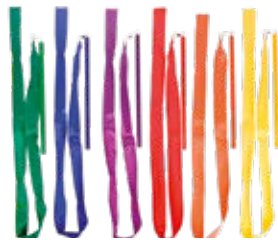

**Ribbons 2 m**  
**TY0105**

- 6 pcs



**Blindfold 1 piece**  
**US0301**

- dim.: 16 x 7 cm;
- material: soft nylon fabric

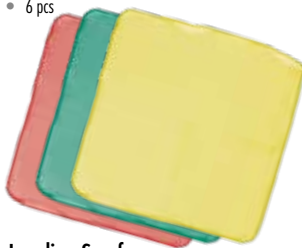

**Juggling Scarf**  
**US0262**

- dim.: 40 x 40 cm;
- assorted colours (red, green, yellow)



**Vests with numbers**  
**TY0217**

- 12 pcs;
- universal size
- colours may vary



**Big cones**  
**TY0015**

- 4 pcs, H 50 cm;
- with holes

**Cones**  
**FI2200**

- 6 pcs, H 30 cm;
- with holes



**Round Safety Cones**  
**FI0005**

- 50 pcs in 6 colours, ø 19 x 5 cm

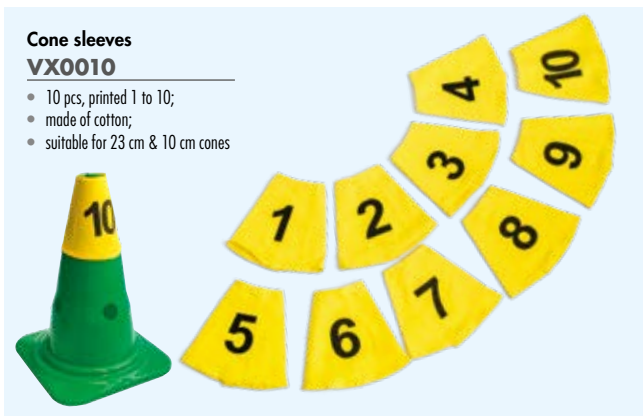

**Cone sleeves**  
**VX0010**

- 10 pcs, printed 1 to 10;
- made of cotton;
- suitable for 23 cm & 10 cm cones



**Figure bags**  
**NS0132**

- 4 pcs, 10 x 10 cm

## BEANBAGS



**Beanbags**  
**NS0126**

- a set of 4; 10 x 10 cm



**Alphabet bags**  
**NS1930**

- 26 pcs



**Number bags**  
**NS1982**

- 7 x 12 cm, 12 pcs



**Bean bags.**  
**Colours**  
**NS0135**

- 10 x 13 cm;
- 8 pcs





**Maths figures.  
Sensory bags in sack  
NS2071**

Colourful sensory bags of different shapes and textures filled with plastic pellets. 6 bags in 6 colours and shapes.

- 6 shapes dim. ca 15 cm: rectangle, triangle, square, circle, hexagon, diamond
- dark blue drawstring sack dim.: 21 x 25,5 cm



**Emotions. Sensory bags in sack  
NS2070**

A set of round plastic-filled bean bags embroidered with smiley faces illustrating basic emotions. Made of durable nice-to-the-touch fabric in pronounced colours. Each emotion is represented by a different colour

- 7 elements: yellow bag - joy, orange - indifference, violet - surprise, blue - sadness, green - fear, red - anger;
- the whole set comes in a nice drawstring sack (19 x 22 cm);
- filling: plastic pellets;
- bag D 12,5 cm





Bags filled with nice to touch plastic balls with embroidered inscriptions to help children learn to read and memorise the days of the week, months and seasons of the year. They are perfect for active learning how to read or sort. Their vivid colours make them interesting to look at, and they encourage children to play with them. Thanks to the embroidered inscriptions, the bags are long-lasting and they don't lose their educational value.



**Bean bags - season of the year. Polish-English version  
NS2672**

- dim.: 10 x 13 cm



**Bean bags - days of the week. Polish-English version  
NS2670**

- dim.: 10 x 13 cm



**Bean bags - months of the year. Polish-English version  
NS2671**

- dim.: 3 x 7 cm



## HURDLES



**Colourful hurdles**  
**TY0631**

- 4 pcs, L 66, H 19 to 35 cm

**Hurdle**  
**TY0633**

- dim.: 30 x 45 cm, 3 heights



**School hurdle**  
**VX0888**

Made of steel, lightweight yet sturdy. This is one of the best hurdles for school level competitions & practice. It features galvanised hurdle legs, powder coated top and plastic gateboard with 5 height adjustments as per IAAF rule. This hurdle comes packed in a box in dismantled state. Can be easily assembled/dismantled for easy storage and transportation.

- 1 pc



## EXPANDERS



**Pink**  
**F10342**

- light

**Blue**  
**F10341**

- medium

**Green**  
**F10340**

- heavy



# GYMNASTIC ACCESSORIES



**Acupad feet**  
**US0267**

Foot pads with raised plastic nodules. Stepping on them is a great therapeutic exercise - it helps reduce stress and stimulate neural receptors.

- pair of pads, left and right; L 20 cm



**Acupad Hand**  
**US0266**

Stimulate various parts of your body using our acupad hand. Helps reduce stress and anxiety, increase blood circulation and energy flow throughout the body. Ideal for therapeutic use.

- 2 pcs; left and right; L 17 cm



A series of colourful rubber elements to use for play both in a playground and the playground. All-purpose, easy-to-clean, made of elastic yet durable material.



**Feet prints**  
**TY0072**

- 6 pairs, 22,5 cm



**Hands prints**  
**TY0073**

- 6 pairs, 22,5 cm



**Rectangle**  
**TY0082**

- 6 pairs, L 34,5 cm, W 7,2 cm



**Square**  
**TY5210**

- 6 pcs; size 20 x 20 cm



**Triangle**  
**TY5205**

- 6 pcs, side 11 cm



**Curved arrowhead marker set**  
**TY0086**

- 6 pcs, W 7 cm



**Straight arrowhead marker set**  
**TY0080**

- 6 pairs, L 38 cm, W 7 cm



**Bean bag scarf  
VX4506**

Made of polyester fabric with male velcro on the tips. For use in multiple activities to improve eye & hand coordination as well as target games on which male velcro can stick.

- set of 6 pcs;
- colors: orange, yellow, blue, green, red and purple



**Elastic exercise loop band  
TY1012**

Thick elastic exercise loop band covered with colourful material nice to the touch.

It helps maximize workout effects and focus on selected body parts. For individual practice or in pairs.

- total length 360 cm



**Rubber discs  
US0228**

- set of 3; ø 18 cm

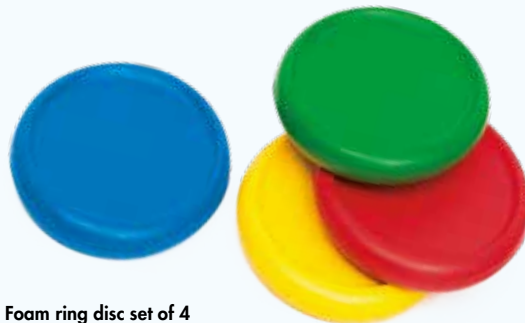

**Foam ring disc set of 4  
US0012**

A set of safe light foam flying discs. Its shape makes catching quite easy. Great for both indoor and outdoor play.

- 4 pcs;
- ø 20 cm



**Ringo  
JG2190**

- 10 pcs; ø 16 cm

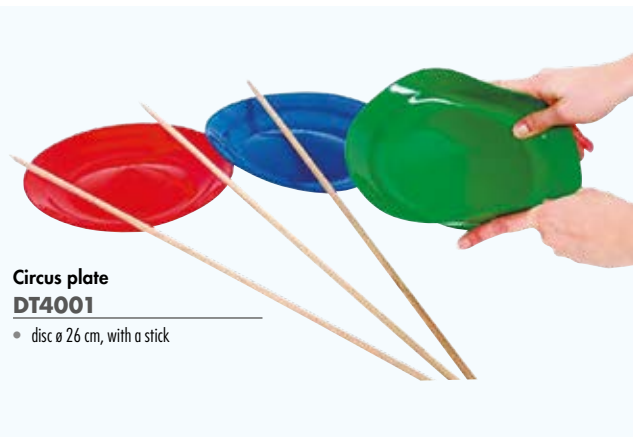

**Circus plate  
DT4001**

- disc ø 26 cm, with a stick





**Wobble Disc**  
**US0482**

- 2 discs ø 15 cm, H 16 cm; 1 ball ø 6 cm

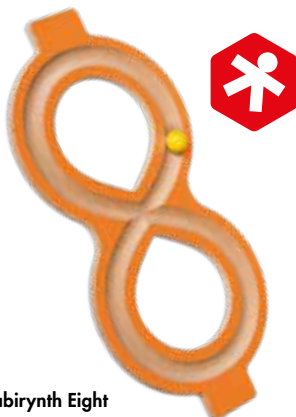

**Labyrinth Eight**  
**NS0421**

- size: 48 x 22 x 2,5 cm., ball ø 3 cm



**Weights 1kg**  
**VX1000**

Weights for strength exercises filled with sand. Covered with a layer of high-quality synthetic material which is easy to clean and prevents the absorption of moisture and sweat. Essential during aerobics, exercises to strengthen the muscles of the whole body, as well as for rehabilitation.

- 1 pc; weight: 1 kg;
- material: synthetic material;
- filling: sand;
- colours may change



**Catch a cap**  
**US0131**

Hit the ball and try to catch it into the cone connected with the ball by a string. The game develops coordination and reflexes.

- 6 pcs in 6 colours;
- cone height 16 cm, ball diameter 7 cm, string length 85 cm

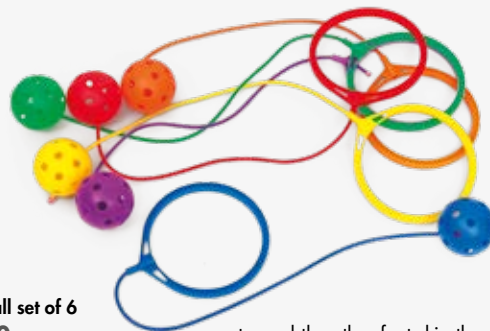

**Swing ball set of 6**  
**US0130**

Put your foot into the loop at the ankle and swing the foot into a small circling motion to set the ball spinning around that foot. When the ball comes

toward the other foot skip the rope. Good for developing coordination and strengthening leg muscles. The whole toy is made of plastic.

- 6 pieces, L 73 cm, Loop diameter 14 cm

## GAMES



**Giant Badminton set**  
**BO6512**

A badminton set – two badminton rackets with a wide net and a big shuttlecock.

- dim.: 65 x 32 cm;
- 2 badminton rackets, 1 shuttlecock;
- material: metal, plastic, net;
- age: 3+



**Badminton racket**  
**FI0109**

- 2 rackets;
- material: plastic

**Giant Badminton**  
**FI0165**

- 6 pcs;
- 2 sizes: 9 cm



**Toss and catch gloves with ball**  
**US0494**

Durable velcroed light-material gloves for catching a ball.

- 4 elements;

- 2 x gloves;
- dim.: 19,5 x 18,5 cm (universal size);
- 2 x ball; D 6,2 cm;
- materials: fabric, plastic;
- ages 5+



**Golf academy chipping set**  
**US0413**

- a golf kit:  
6 clubs in 6 colours, rubberized grip, L 74 cm  
6 loops and 6 vinyl balls



**Sports day kit**  
**DW8882**

An agility kit for 4 contestants

- 32 elements:  
4 bags,  
9 tumblers,

- 4 bags,
- 4 spoons,
- 4 plastic eggs,
- 4 plastic nails,
- 2 tapes for start and finish lines



**Hockey sticks**  
**TY6103**

- 85 cm x 12; sticks plus disk



### Serso. Game of skill VX0106

Serso is perfect for group playtime on fresh air, but it also provides just as much fun indoors when it's raining. Additionally, it trains motor skills, hand-eye coordination and helps to strengthen social bonds. The set contains 6 hoops, 2 steel bearers/misericords and metal stand in the form of a cross with a rubber foot at the bottom.

- 9 pcs;
- material: metal, plastic, rubber



### Wooden serso CI4630

Wooden Serso game. It is an arcade game consisting of throwing a circle on a protruding element from the board. Thanks to the fact that the board is movable, the games is not repetitive.

- dim.: 36 x 36 x 16 cm;
- age: 3+



### Finnish skittles BO2350

A game of skill in which you need to throw accurately, count efficiently and use the right strategy. The players throw a wooden bat so as to knock down numbered skittles and be the first to obtain 50 points.

- 12 skittles numbered 1 to 12, 1 bat;
- dim. 22 x 4.6 cm; material: wood;
- number of players: 2 or more;
- age: 6+



### Tic Tac Toe. Floor game VX0101

Floor version of Tic Tac Toe which involves not only the mind but the whole body. It provides great fun indoors and outdoors.

- 10 tags (5 with a circle in yellow, 5 with a cross in blue), a mat and a mesh bag for storage;
- dim. of the mat: 1 x 1 cm;
- material: polioplyrene

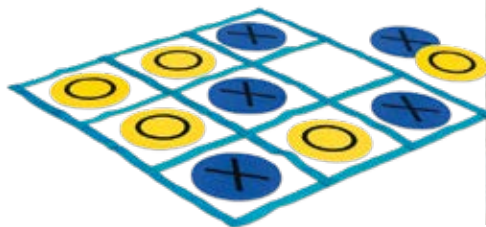

# WOODEN GYMNASTIC AIDS

Climbing on and off the balance box using the ladders' steps require keeping balance and helps to shape correct posture. Easy fixing enables combining many elements to create a longer obstacle course.

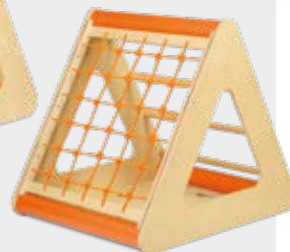
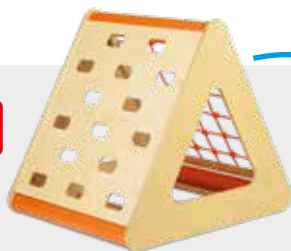

## Gymnastic triangle NS6002

Gymnastic triangle made of waterproof painted plywood. Each party allows the improvement of coordination.

- 3 activities possible: climbing wall, wall car and ladder; size: 104 x 117 x 93 cm

## Gymnastic cube NS9160

This gymnastic device consists of various climbing walls. In the middle of the structure there is a free space that can serve as a tunnel in the obstacle course. Thanks to the holes and rungs, a roller platforms and sensory path can be attached.

- made of birch plywood;
- dim.: 105 x 105 x 105 cm



various climbing walls



## Balance box NS9162

The balance box is used for climbing and balancing. Thanks to the holes on each side, a platform and ladders can be attached.

- for indoor use;
- dim.: 79 x 44 x 58 cm

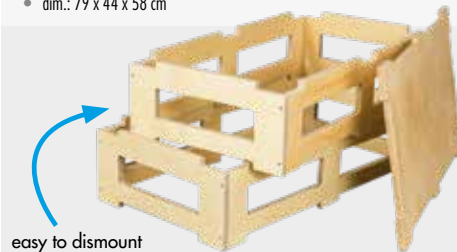

easy to dismantle

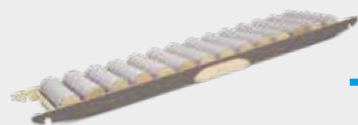

+



=



### Double roller platform NS9085

Double roller platform helpful during various therapeutic activities. It is made of birch deciduous plywood.

- dim.: of one element: 134 x 64 x 17 cm;
- dim.: of two rollers joined together: 268 x 66 x 17 cm;
- the dominant colour of the product is orange



### Roller platform ladder NS9086

Ladder designed for roller platforms. It is equipped with 5 rods on which roller platform can be mounted.

- dim.: 66,5 x 50 x 54 cm



### Roller platform NS9172

Exercises with the roller slide affect the improvement of control and

movements, postural reactions, muscle tension, and motor coordination.

- PVC covered high-density foam;
- dim.: 62 x 11 x 150 cm

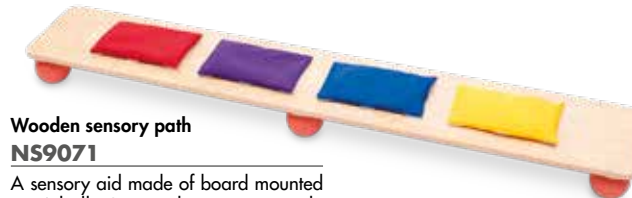

### Wooden sensory path NS9071

A sensory aid made of board mounted on 6 balls. It provides various tactile sensations and stimulates sensory receptors. Stimulants for feet are 4 bags with various fillings. They are fastened to the board with velcros for quick replacement and prevent them from sliding off.

- 5 elements: board 125 x 24 x 10 cm; 4 bags 14 x 25 cm;
- materials: plywood varnished, fabric;
- filling: fine gravel, upholstery foam offcuts, styrofoam chips, plastic pellets D 3mm



### Sensory Path NS9169

- dim.: 27 x 11 x 150 cm

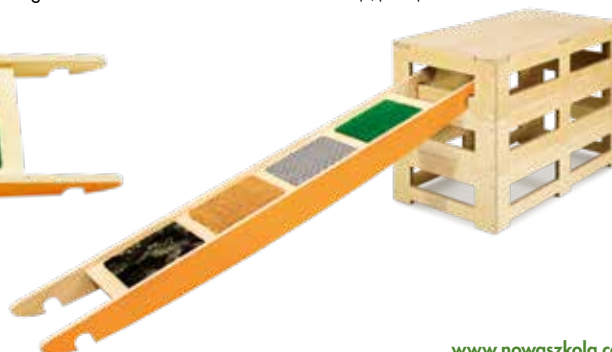

**Chest with beams - set  
CS2005**

Set for balancing exercises which enables creating obstacle courses that provide the variety of activities during sports classes or other physical activities. The proposition of the set consists of base and four beams. The base has a 3 level regulation for the beams. Each ramp has a different texture that provides sensory feelings. All elements are made of varnished plywood.

- base with matress, 4 beams: with matress, with grass, with channels, with bars



**Base with matress  
CS2000**

- dim.: 86 x 86 x 65 cm (without the matress);
- matress thickness 3 cm

**Beam with matress  
CS2001**

- dim.: 200 x 21 cm

**Beam with grass  
CS2002**

- dim.: 200 x 21 cm

**Beam with channels  
CS2003**

- dim.: 200 x 21 cm

**Beam with bars  
CS2004**

- dim.: 200 x 21 cm

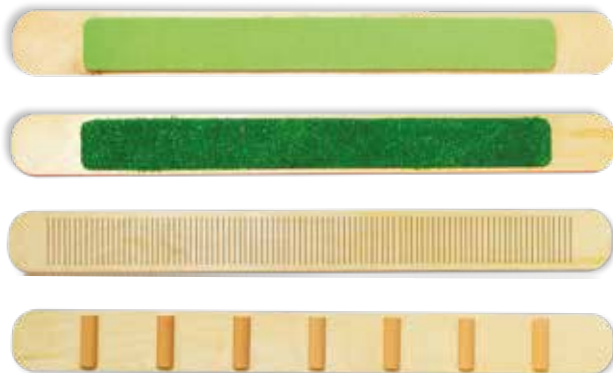

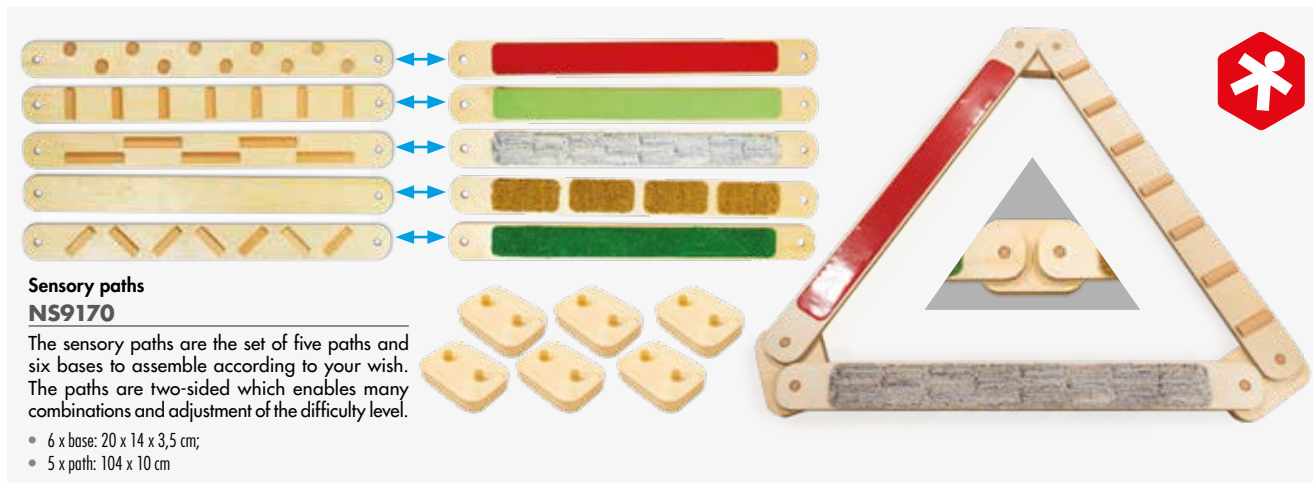

### Sensory paths NS9170

The sensory paths are the set of five paths and six bases to assemble according to your wish. The paths are two-sided which enables many combinations and adjustment of the difficulty level.

- 6 x base: 20 x 14 x 3,5 cm;
- 5 x path: 104 x 10 cm

### Bench 3 m CS3009

- dim.: 300 x 22 cm

### Bench 2 m CS3010

- dim.: 200 x 22 cm



### Climbing Net BO5145

A climbing net made of a steel rope to be fixed to a wooden or metal frame.

- net size 180 x 300 cm;
- rope  $\varnothing$  1,2 cm; mesh 30 x 30 cm



**Semicircle.  
Climbing frame  
NS0947**

- dim.: 98 x 44 x 50 cm



**Cradle  
NS9166**

The cradle is a multi-purpose product. In its standard arrangement it has a form of a cradle. Turned upside down it can function as a bridge over a flowing river. Placed on the side it can serve, for example, as a shop counter or crash barrier.

- dim.: 78 x 41 x 36 cm



**Triangle.  
Climbing frame  
NS0946**

- dim.: 90 x 80 cm



**Semicircle. Climbing frames  
BY2209**

- 4 pcs;
- ø 132 cm x 40 cm

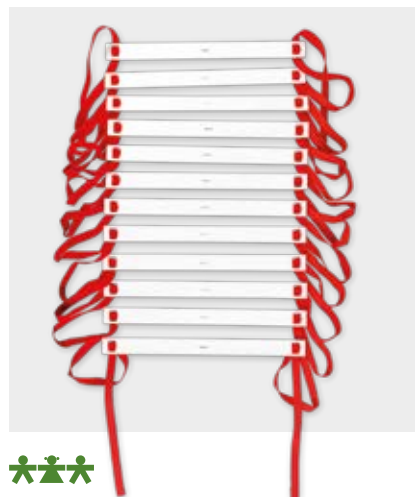

**Agility ladder with bag  
TY4080**

- size: 350 cm





# MINI GYM

- material: metal, foam covered with PVC fabric;
- load: up to 68 kg;
- age: 3-8



**Rowing machine**  
**SG0006**

- size: 86 x 64 x 57 cm;



**Training bike**  
**SG0004**

- size: 75 x 38 x 90 cm



**Air walker**  
**SG0003**

- size: 78 x 65 x 80 cm



**Weight bench**  
**BO0112**

- size: 90 x 81 x 77 cm; age: 4-8



**Treadmill 1**  
**SG0001**

- size: 83 x 65 x 80 cm



**Treadmill 2**  
**SG0002**

- size: 90 x 75 x 85 cm



**Stepper**  
**SG0007**

- size: 45 x 39 x 89 cm



**Twister**  
**SG0005**

- size: 40 x 45 x 89 cm

# TRICYCLES



**Tricycle  
YC6508**

A sturdy-frame tricycle for secure riding. Push-powered or pedal-powered. Small enough to be used at home or pre-school.

- size: 88 x 54 x 63 cm



**Twister  
TY0012**

Manually-powered ride-on vehicle. It moves by turning the steering wheel left and right.

- L 75 cm, H 36 cm, W 28 cm;
- age: 3+



**Two-seat tricycle  
YC6601**

A tricycle for older children, with a rear seat. Instead of the second pair of pedals a comfortable footrest (also usable for transporting things).

- size: total 112 cm x 54 cm x 63 cm;
- platform 36 cm x 42 cm



**Tricycle with trailer  
YC6605**

A tricycle with a trailer for older kids. Very stable thanks to the suitable wheel alignment and low centre of gravity. The trailer can be used to transport sand, toys or other objects.

- size: 110 cm x 54 cm x 63 cm in total;
- trailer 34 x 15 x 45 cm



## TRAMPOLINES



**Trampoline with support  
BO1028**

- ø 139 cm, H 180 cm, up to 55 kg



**Trampoline with handle  
BO1056**

- size: 120 x 118 cm;
- up to 50 kg



**Round trampoline  
BO9841**

- ø 102 cm, up to 100 kg



**Foldable trampoline  
BO9842**

- ø 102 cm, up to 100 kg



# PARACHUTES, TUNNELS & TENTS

## Activity Parachute TY0121

- ø 3,5 m



handles



pockets  
with mesh



letters & numbers

## ROUND PARACHUTES



handles

- ø 1,75 m

### JG2301

- 8 handles

- ø 3,5 m

### JG2302

- 8 handles

- ø 6 m

### JG2304

- 12 handles





### Parachute Recta VX0081

Rectangular shaped long parachute made of six colours polyester fabric. Borders are tape reinforced with 34 handles. Great fun product for improving supportive activities and play.

- size: 8 x 1 m



### Parachute Octa VX3516

Hexa shaped parachute made of four colours polyester fabric & eight coloured panels with 2 handles on each panel. Great fun product for improving supportive activities, eye & hand coordination.

- size: 3,5 m



### Methodological guide. Fun with the parachute and play tunnels. Polish-English version NS1372

Polish-English guide created to collect playtime ideas with the parachute and tunnels. This publication contains 40 playtime ideas divided into months and weeks. In the months from September to June, we will find 4 games for each month: two propositions with the parachute, one with the parachute and tunnels, and one proposition with tunnels. The last part of the guide consists of 5 playtime scenarios. 1 with the parachute, 1 with the parachute and tunnels, and 1 with tunnels. These ideas were prepared with preschool and primary school teachers in mind as well as those working in after-school clubs. However, all activities can be introduced during kindergarten and school events such as picnics, competitions, open days.



# TUNNELS & TENTS



**Tunnel**  
**ES2172**

- dim.: 150 cm x 45 cm;
- bag

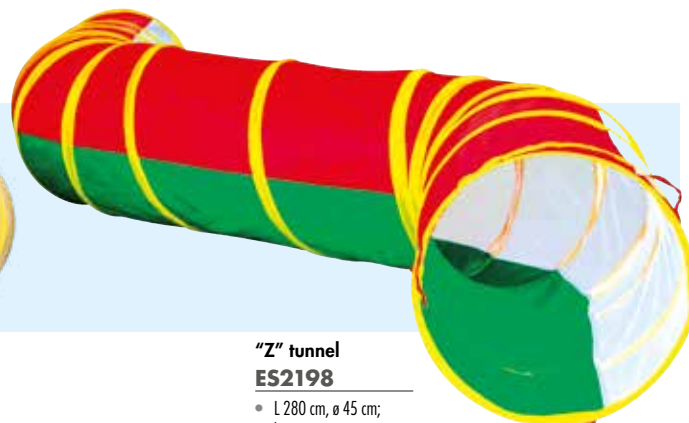

**"Z" tunnel**  
**ES2198**

- L 280 cm, ø 45 cm;
- bag



**Caterpillar tunnel**  
**ES8601**

- L 185 cm, ø 50 cm



### Play Tunnel NS1656

A long play tunnel for developing agility and stimulating imagination. Made of durable fabric, its is ideal for both indoors and outdoors. A drawstring sack included.

- L 270 cm;
- circumference 100 cm;
- bag

### Tunnel X DW8907

Made of soft polyamide fabric. Easy assembly and storage. Ideal in playrooms and outdoors.

- size: 230 x 230 x 46 cm

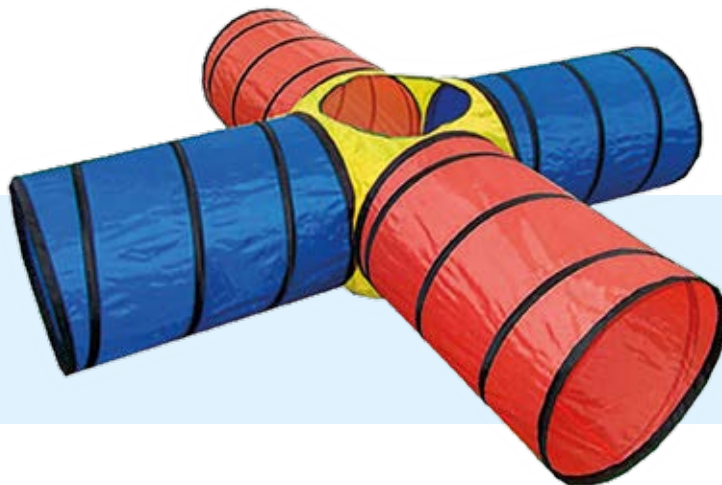

### Transparent tunnel ES2098

The transparent fabric ensures comfortable play and therapy for emotionally disturbed or autistic children. The product can be instantly shortened and kept in a round carrying bag.

- dim.: 180 x 60 cm;
- bag;
- age: 3+



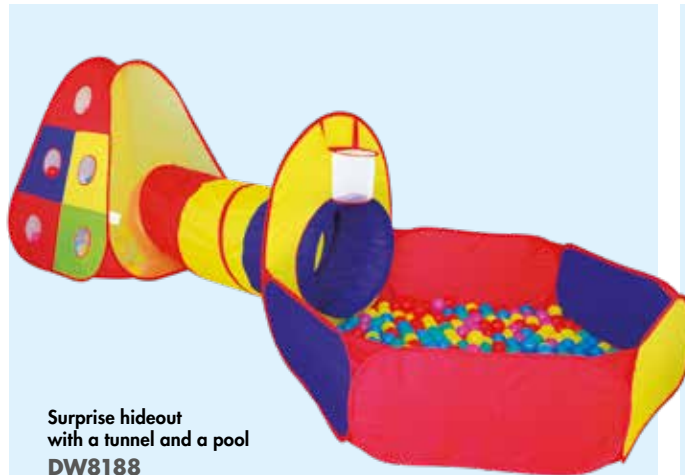

**Surprise hideout  
with a tunnel and a pool**  
**DW8188**

The set consist of a tent, a tunnel and a pool. All these elements provide lots of fun. One wall of the hiding place is enriched with a board for throwing Velcro balls, while the other has got mesh baskets for throwing plastic balls.

- dim.: 300 x 120 x 100 cm;
- fabric: 100 % polyester;
- frame: flexible steel wire;
- 100 plastic balls, 3 balls with velcro



**Space. Tent with a tunnel**  
**DW8198**

Space tent consisting of a tent and a tunnel leading inside. The tent is reinforced with a flexible steel wire.

- dim.: 165 x 95 x 85 cm;
- fabric: 100 % polyester

**Adventure tunnel playset**  
**DW8201**

- 3 tunnels ø 46 cm, L 88 cm;
- tent 105 x 105 x 85 cm;
- houses 93 x 67 x 100 cm;
- centre circle 90 x 47 cm



**Tent with connecting tunnel**  
**DW8903**

- tunnel: ø 44 cm, L 175 cm
- house 104 x 104 x 94 cm







**Adventure tent set  
DW8206**

- tunel ø 46 cm, L 140 cm;
- house 90 x 75 x 65 cm;
- tent 75 x 75 x 80 cm



**Pirates. Round tent  
DW8735**

- dim.: 105 x 125 cm;
- fabric: 100 % polyester, mesh: polyester, poles: fiberglass



**Indian tent  
DW8172**

- dim.: 120 x 120 x 152 cm;
- blue



**Playhouse  
DW8003**

- dim.: 100 x 98 x 72 cm

# PLASTIC PLAYGROUND



## Mini playground NS4107

- with slide, basketball and bowling
- size: 160 x 97 x 105 cm;
- age: 2+



## Slide and Rocker NS4207

- size: 83 x 48 x 50 cm;
- age: 3+





for inside  
or outside use



# nomino®

Construct your own obstacle course from colourful Nomino bridges, steps, slides and tyres. These big durable plastic blocks can be used both inside and outdoors. The variety of forms, fabulous colours, interesting textures of certain elements add to the fun of overcoming obstacles and help adjust the difficulty level to the age and fitness of each child.

## Nomino starter NO1000

- 6 pcs



**H base**

- size: 56 x 30 x 50 cm



**Stairs**

- size: 60 x 50 x 50 cm



**Central base**

- size: 65 x 65 x 50 cm



**Tyre beam**

- size: 120 x 72 x 28 cm

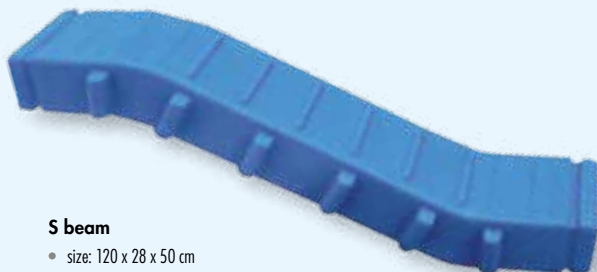

**S beam**

- size: 120 x 28 x 50 cm

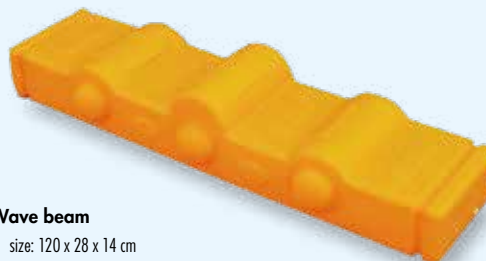

**Wave beam**

- size: 120 x 28 x 14 cm