

2019 / 2020



# mobiliario

**nowa szkoła**  
international





For over 25 years, Nowa Szkoła has been creating and promoting a new look at the children's world of education. With each year we gain experience and knowledge, which we translate into higher-quality services geared towards developing the educational space.

We know very well the needs of children and teachers. Yet, in order to be absolutely sure that our offers will fully meet their expectations we consult qualified educators about each new product idea. And for the testing phase we invite children – the best experts on quality and safety.

To be competitive we have always observed certain principles. Thanks to our good planning and implementation, choice of top-quality materials and professional workmanship our products are safe for children and user-friendly for teachers.

Our priorities are always our customers' needs and transparency of business practices. By adhering to these fundamentals, we wish to strengthen our good relations with clients.





furniture 7 - 243

education 360 - 588



icons



new



magnetic



washable



only in NS



PVC phtalate free



new colours



printed



2019/2020  
international

furniture	7 - 243
activity play	244 - 359
education	360 - 588

activity play  
244 – 359



CARPENTRY SHOP

The expertise and experience of our specialists are reflected in the quality of our products.



SEWING WORKROOM

All our foam soft play shapes are produced by highly qualified seamsters and seamstresses.



## PACKING



## WAREHOUSE

Our warehouse is large, which allows quick and easy access to our products and hence fast order processing. Before shipment, each package is carefully checked and secured so that it can reach our customers intact.



## DESIGN

It is quite a long process before a product is released. Everything starts with the concept. Then come sketches and technical drawings. Next, prototypes are created and rigorously tested. Only after that can the design be put into mass production.

Thanks to our experience we are able to shorten the long production process to several days and thus meet any short-notice challenges from our customers.

## CERTIFICATION

We care about the highest standards of our furniture. The excellent quality of our products is confirmed by international certificates and awards.



# we use

only certified materials



birch



beech

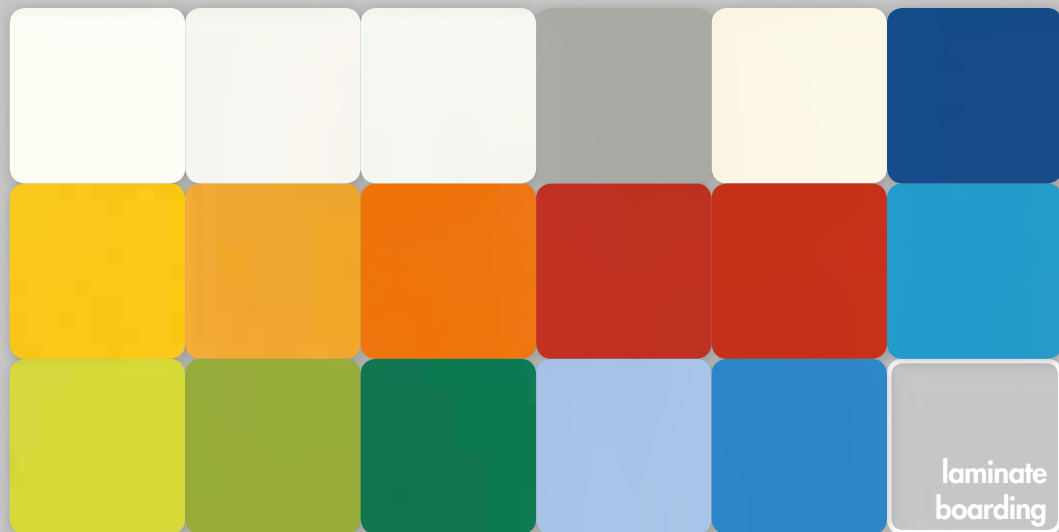

laminate  
boarding



PCV





furniture







# MODUL+

COMBINED WITH IMAGINATION

Module PLUS is a series of cabinets which can be secured to frames in two heights. In this way, freestanding sets of modules in complex arrangements can be obtained. The frames can connect whole units, shelves and partitions.

#### Cabinets:

- finish: birch
- edging: PVC
- cabinet handles included

#### Framework:

- varnished plywood
- 2 heights: 78.5 and 168.5 cm
- accessories sold separately (shelves, decorative elements, boxes)

lockers and fronts

birch

laminated board

frame

laminated plywood



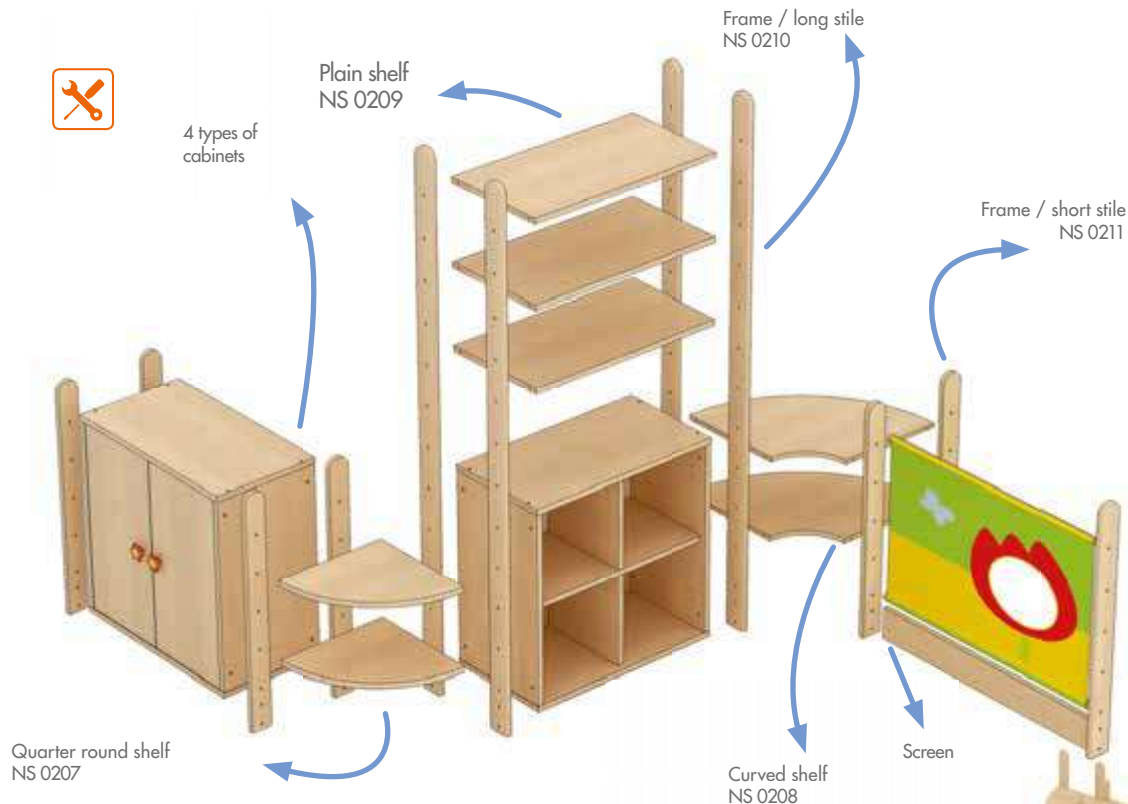

## HOW TO CONNECT MODULES IN MODUL+

### + Cabinets

4 types. They can be attached to frames of either type to form complex units

### + Shelves

Plain, quarter circle or quarter arc - they can be connected with cabinets, partitions or other shelves with frames to form constructions of varied heights.

### + Frames

Long and shorter stiles. They are the key construction element of the series.

### + Partitions

2 heights. They can be connected with other units in the series. Sold together with the frames.



# A MATTER OF IMAGINATION



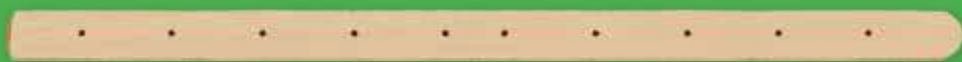

**Shelf frame (high)**

NS 0210

To secure cabinets, shelves and screens

- 160 x 7 cm, 1 pc.



**Shelf frame (low)**

NS 0211

To secure cabinets, shelves and screens

- 75 x 7 cm, 1 pc.





### Shelf 1/4

NS 0208

For joining modules at 90° angle

- side L 36 cm



### Shelf 90°

NS 0207

For joining modules at 90° angle

- side L 36 cm

### Plain shelf

NS 0209

For joining modules

- 65 x 35 cm

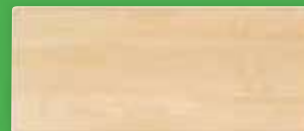

### Module / doors + shelf

NS 0575

- shelf inside
- 65 x 35 x 65 cm



### Module / shelf + separation

NS 0574

- 4-compartment unit accessible from both sides
- 65 x 35 x 65 cm



### Module / 1 door + shelf

NS 0576

- door on the left or right
- 65 x 35 x 65 cm



### Module / shelf

NS 0573

- accessible from both sides
- 65 x 35 x 65 cm



### Wicker container

This aesthetic bin fits the cubby holes of Modul PLUS. The plywood bottom ensures stability and durability

- 28 x 28 x 20 cm



Red

NS0606



White

NS0605



Dark Blue

NS0607



Natural

NS 0603

## Tall Screens 90 x 167 cm

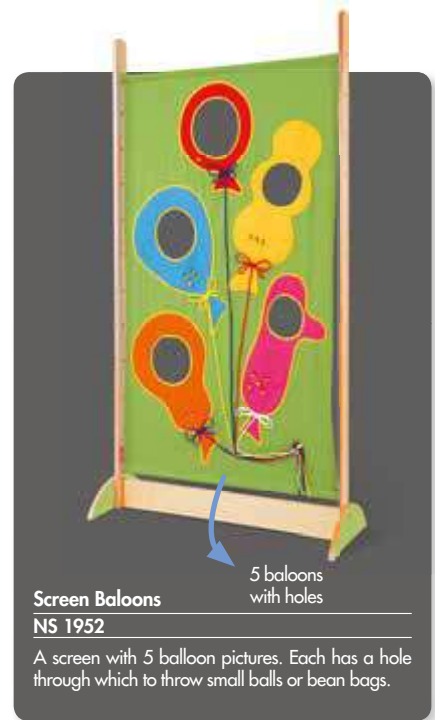

## Small Screens 90 x 77 cm

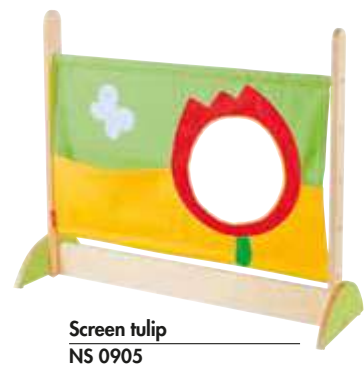





**Colourful theatre**  
NS 1955

It features drawable curtains and large pockets for storing puppets or smaller props. A long pocket for displaying the title of the play and the actors' names.



**Screen Sailing boats**  
NS 1954

A screen with 5 sailing boat-shaped pockets varying in size, colour and the number of buttons.



**Screen Connectors**



90° - 2 pcs.  
NS 0958



60° - 2 pcs.  
NS 0957



Straight - 2 pcs.  
NS 0956

**screens**

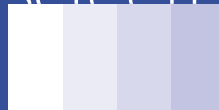

They can be installed between our Module PLUS units. Mounted on a plywood frame they can be used stand-alone. Using fasteners of several types, successive segments

can be joined at different angles. Tall screens can be used to form decorations, to organize games or simply to divide room space. Fabric is provided with aluminium tubes and frames.

### Storage units with pockets

mobile units with large pockets for storing e.g. toys. The pockets have geometrically-shaped openings and Velcro straps for easy detachment for washing.



#### Tall unit

**NS 0940**

- 40 x 40 x 115 cm,
- 3 pockets

#### Low unit

**NS 0941**

- 40 x 60,5 x 82 cm,
- 2 pockets



#### Set of low partitions

**NS 9500**

- low partitions 90 x 70 cm (different colours) – 7 pcs
- connectors 90°, 2 sets
- connectors 120°, 2 sets









body birch  
laminated board

fronts mdf

hideaway  
playhouse  
with pvc  
element

appliqués

containers on castors

funny  
millings

soft poufs

Minty is a collection in light pastel colours which combines functionality with aesthetic appeal. Its diverse modules have been specifically designed to meet the demands of the young, their daily rhythm and habits. The set consists of open and closed cabinets, storage cabinet for beds and linen and soft seats on castors. A unique element is a playhouse with a soft moulded floor - a safe hideaway and place for play. The set also includes a minder's desk, which harmonizes with the whole series, and a large carpet

with animal motifs (the same as on the cabinets)

- colour: neutral light green
- storage for beds and linen
- hideaway playhouse with roof and foam floor
- 6 versions of cabinets - doors with animal motifs
- cabinet with 4 foam pouffes
- cabinet with castored chests (frogs)
- desk with lockable door for minder
- chest set Caterpillar
- corner cabinets
- changing table



**Pouf set**  
**NS 3214**

- 4 pcs., 40 x 40 x 23 cm

**Cabinet for chests or poufs**  
**NS 3200**

- 100 x 40 x 76 cm

**Chest Frog**  
**NS 3211**

- 1pc., 50 x 40 x 45 cm

**Chests Frogs**  
**NS 3212**

- 2pcs., 50 x 40 x 45 cm

- 3 pcs.
- removable Top – foam covered with PVC fabric
- containers – laminated boarding
- on castors



**Chest set Caterpillar**  
**NS 3213**

- 3pcs., 36 x 30 x 30 cm



**Cabinet with 2 doors**  
**NS 3202**

- 100 x 40 x 76 cm

1 shelf  
inside



**Cabinet with doors**  
**NS 3201**

- 50 x 40 x 76 cm



Inside – foam covered  
with PVC fabric

Frame – laminated  
boarding

**Hideaway playhouse**  
**NS 3210**

- 82 x 60 x 126 cm





**Carpet Minty  
HK 0009**

3 x 4 m

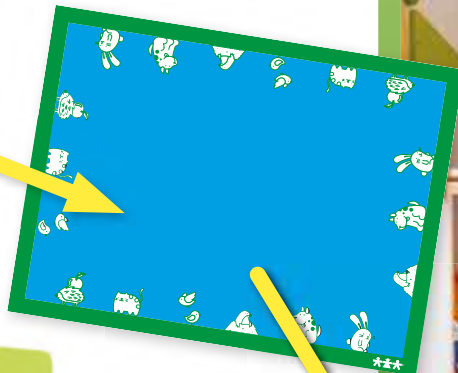

space for 16 bedding sets and 16 cots on trolley

**Storage for beds and linen  
NS 3208**

• 141 x 60 x 200 cm





**Tall unit with 2 doors**  
**NS 3206**

- 100 x 40 x 140 cm



**Tall unit with doors**  
**NS 3205**

- 50 x 40 x 140 cm



**Tall unit**  
**NS 3220**

- 50 x 40 x 140 cm



**Tall unit**  
**NS 3221**

- 100 x 40 x 140 cm



**Hideaway playhouse**  
**NS 3210**

- 82 x 60 x 126 cm



**Cabinet with 2 doors**  
**NS 3202**

- 100 x 40 x 76 cm



**Cabinet with doors**  
**NS 3201**

- 50 x 40 x 76 cm



**Cabinet**  
**NS 3223**

- 50 x 40 x 76 cm



**Cabinet**  
**NS 3222**

- 100 x 40 x 76 cm



**Cabinet**  
**NS 3224**

- 100 x 40 x 108 cm



**Desk**  
**NS 3209**

- 120 x 50 x 76 cm



**Corner unit**  
**NS 3204**

- 80 x 80 x 76 cm



**Inside Corner unit**  
**NS 3203**

- 40 x 40 x 76 cm

minty



**Changing unit**  
**NS 3207**

- 67 x 75 x 100 cm



**Pouf set**  
**NS 3214**

- 4 pcs., 40 x 40 x 23 cm



**Cabinet**  
**NS 3200**

- 100 x 40 x 76 cm



**Chest Frog**  
**NS 3211**

- 1pc., 50 x 40 x 45 cm



**Chests Frogs**  
**NS 3212**

- 2pcs., 50 x 40 x 45 cm



**Chest set Caterpillar**  
**NS 3213**

- 3pcs., 36 x 30 x 30 cm



# Kitchen Island



Oven NS 3215



Washing Machine NS 3216



Sink NS 3217



Fridge NS 3218

A set of wooden furniture which imitates kitchen equipment. The overprints on the doors add a realistic look. The set includes a fridge, washing machine, stove, sink. Each door has a different picture.

The furniture can be used in various configurations: an island in the middle of the room, a row at a wall or as separate pieces in different parts of the room.

- 50 cm x 41 cm x 54 cm



## Kitchen Island NS 3219

- fridge 50 x 41 x 54 cm
- washing machine 50 x 41 x 54 cm
- sink 50 x 41 x 54 cm
- oven 50 x 41 x 54 cm





Train. A chain of storage units imitating a train (engine + carriages). Its length is limited only by the size of the room. The fancy shapes and multicoloured finish turn the room into a fantasy world. A very functional set

which provides a lot of space for display and storage. The cupboards are made of white laminate. The doors, drawers applications in delicate pastel colours add liveliness to the whole interior.



body

laminated board

fronts

MDF

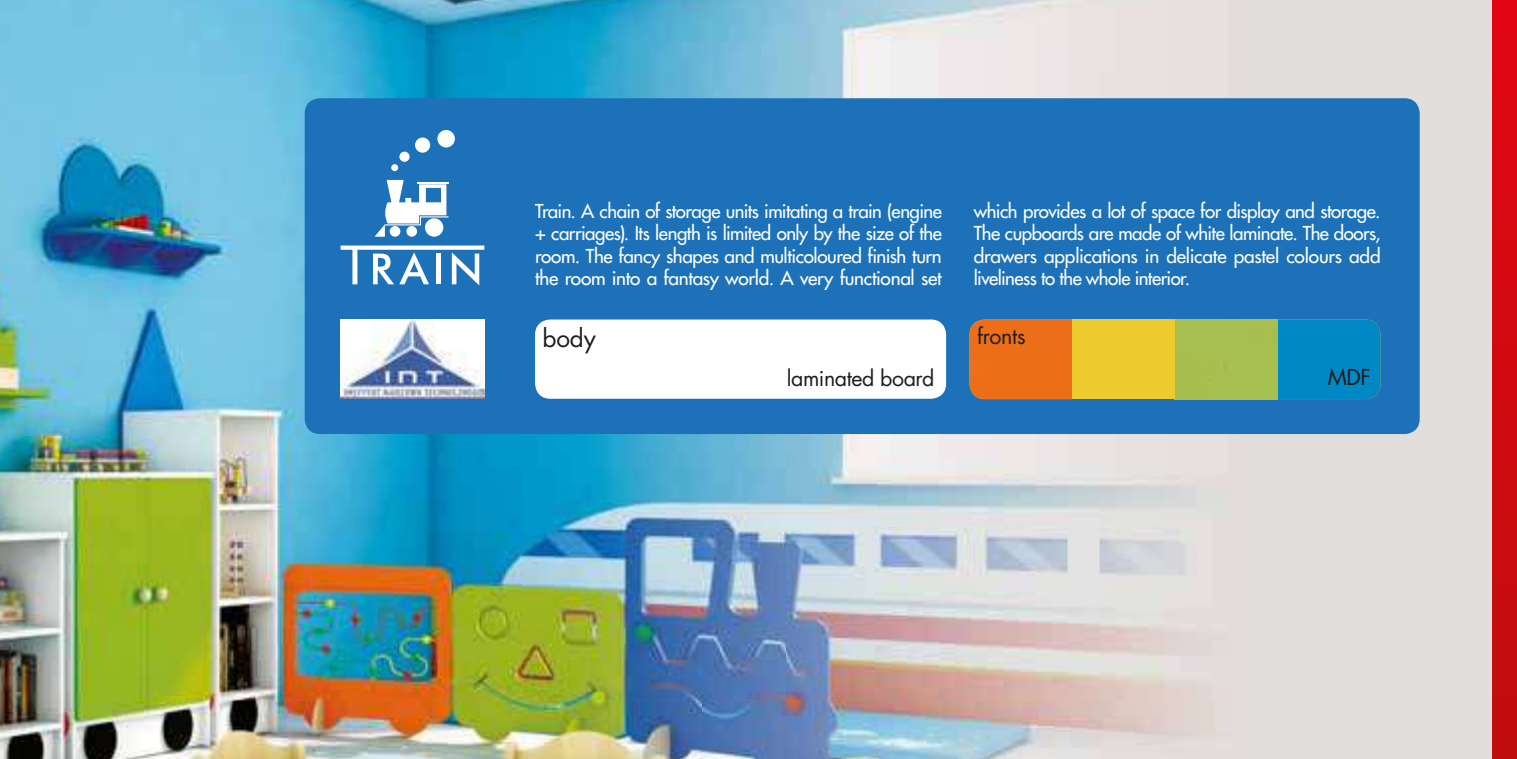

wheel imitations with all modules in the series



colourful decorative back panels



buffer imitations sold separately



spacious drawers with a safety stop

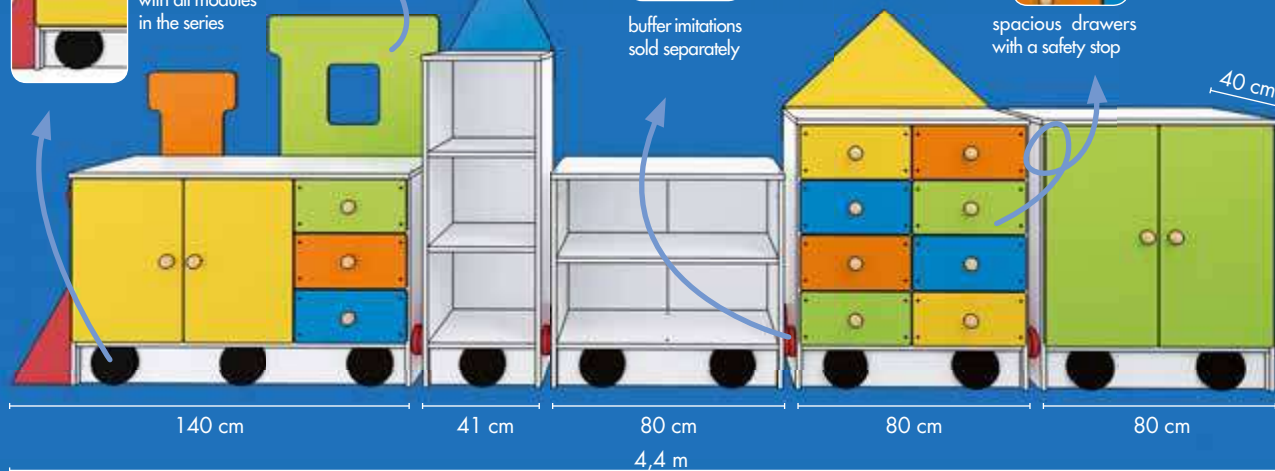

foam bumper and front light imitations come with the engine



**Engine**

**NS 0239**

• 111 x 41 x 135 cm

furniture heights measured with the back panel



**Carriage 1**

**NS 0240**

• 80 x 41 x 135 cm

2 shelves inside



**Carriage 2**

**NS 0241**

• 80 x 41 x 96 cm



**Carriage 3**

**NS 0242**

• 41 x 41 x 153 cm

buffers sold separately



**Carriage 4**

**NS 0243**

• 80 x 41 x 70.5 cm



32 x 42 x 16cm



32 x 42 x 29cm

**White desk**

**NS 0257**

• 120 x 75 x 76 cm



**Train Set**

**NS 0256**

• engine + 4 carriages, total length: 4.4 m with buffers

Total length: 4.4 m

**Buffers**

**LO 0049**





**Dark blue**  
**NS 1773**

• 90 x 22 x 43 cm



**Light blue**  
**NS 1772**

• 90 x 22 x 43 cm



**Shelf sun**  
**NS 8110**

• 70 x 16 x 57 cm



**Shelf grass**  
**NS 8111**

• 82 x 16 x 36 cm



# FANTASY FURNITURE

Each line in Fantasy series features the same modules. The lines differ in the decorative back boards and front cutout patterns.

Heights shown do not include back panels.

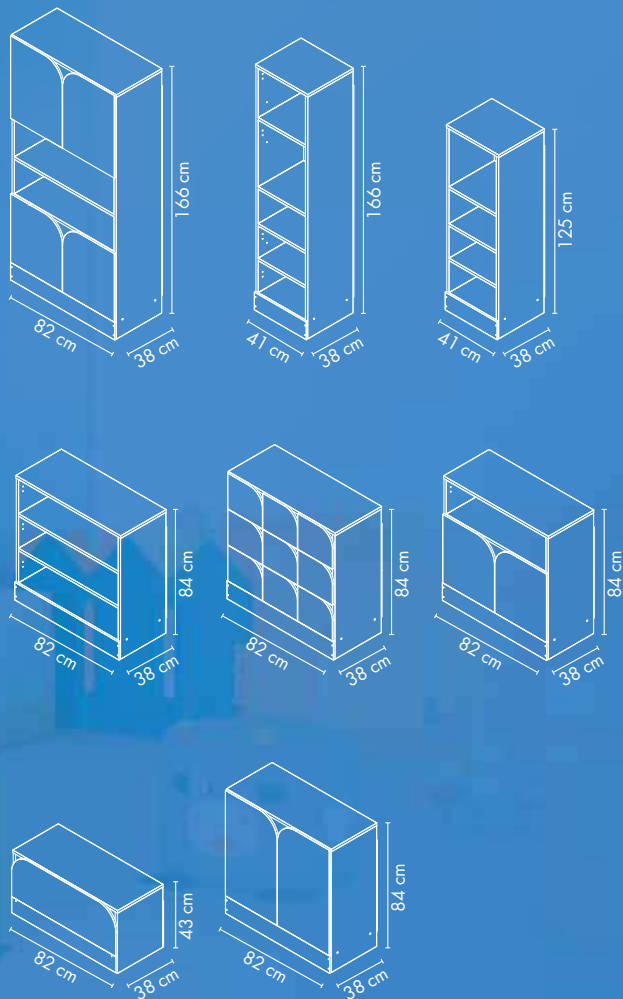

# Fantasy



The series consists of three collections: Farm, Wave and Royal.

Being module-based, they offer freedom of arrangement. Each set consists of the same modules - they only differ in the decorative back boards and front doors.

The furniture is sold - as separate unit or as a set - together with doors and decorative back boards.

The series consists of:

- chest cabinet
- cabinet with door and one shelf
- cabinet with door and 2 shelves
- two tall cabinets of different heights
- cabinet with two doors and two shelves
- cabinet without door (with two shelves)
- cabinet with sliding door
- cabinet with 9 cubby holes
- printed elements

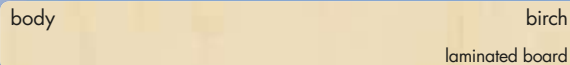

# Jungle

heights shown include  
back panels

Take an exotic trip to the savanna and meet the happy friends from the latest Jungle series. The nine funny animals come from steppes, rivers and rain forests. The warm pastel blues and greens will bring a joyful atmosphere to any interior. The additional desk and poufs follow the design to maintain a consistent look.

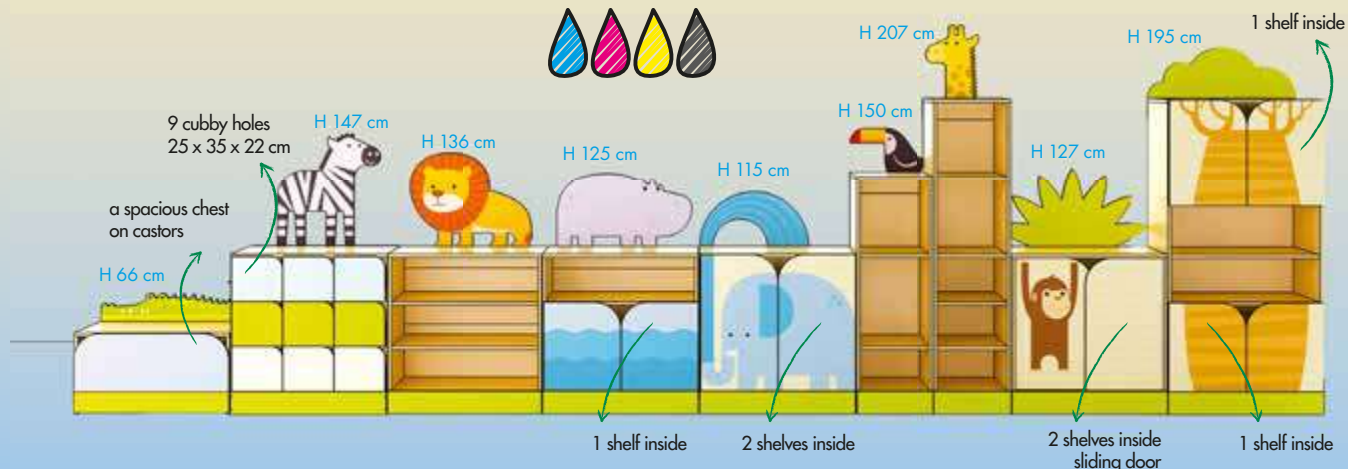

# Wave

heights shown include  
back panels

The blues and turquoises of the sea, shoals of fish and seashells are the leading motifs of the Wave collection. Set out on a sea voyage in a yellow submarine or sit down on the carpet to listen to mysterious sea stories.

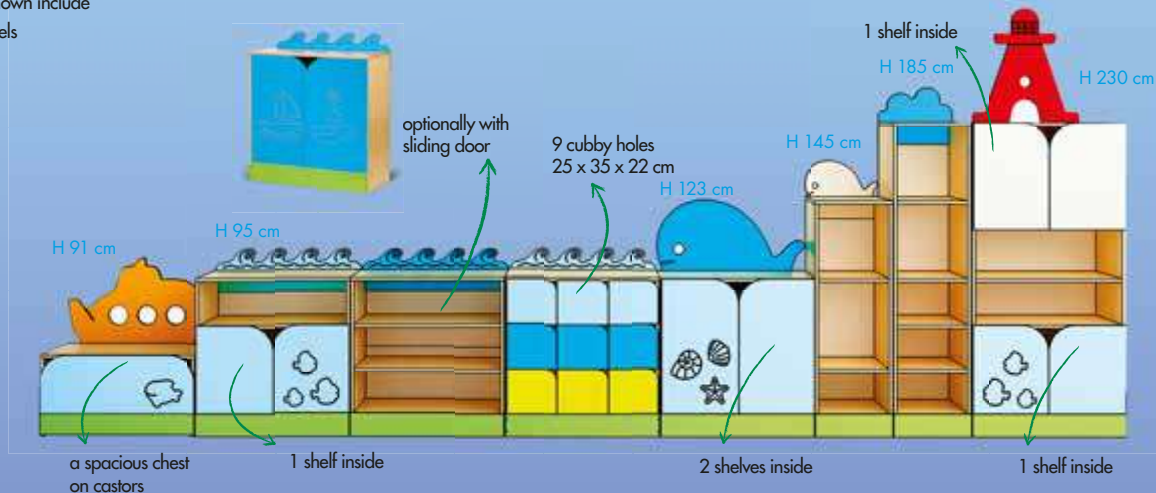





heights shown include  
back panels

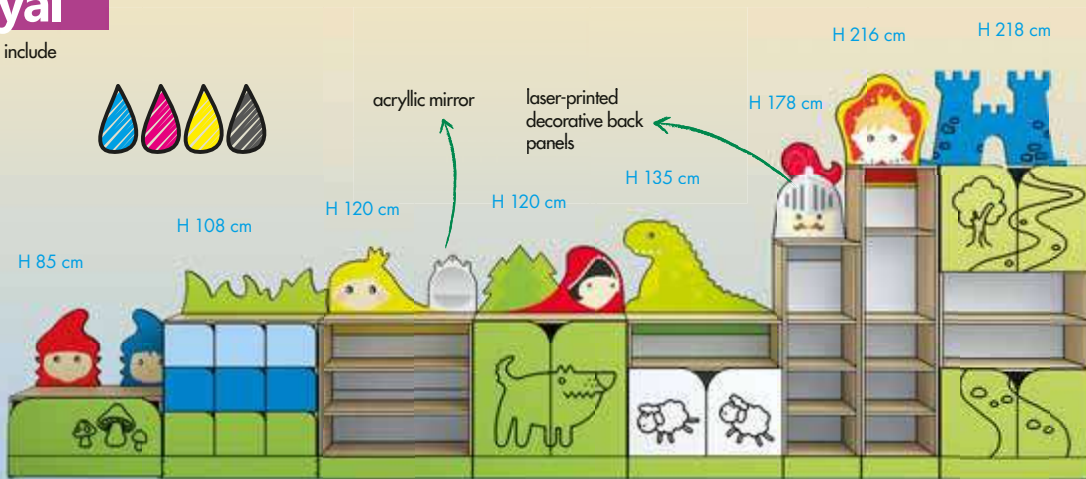

A fairytale collection inspired by children's literature classics. Let your games be guarded by dwarfs, look into the princess's mirror, set out for Camelot Castle or help the Red Riding Hood by locking the Wolf in a cabinet.

## Farm

heights shown include  
back panels

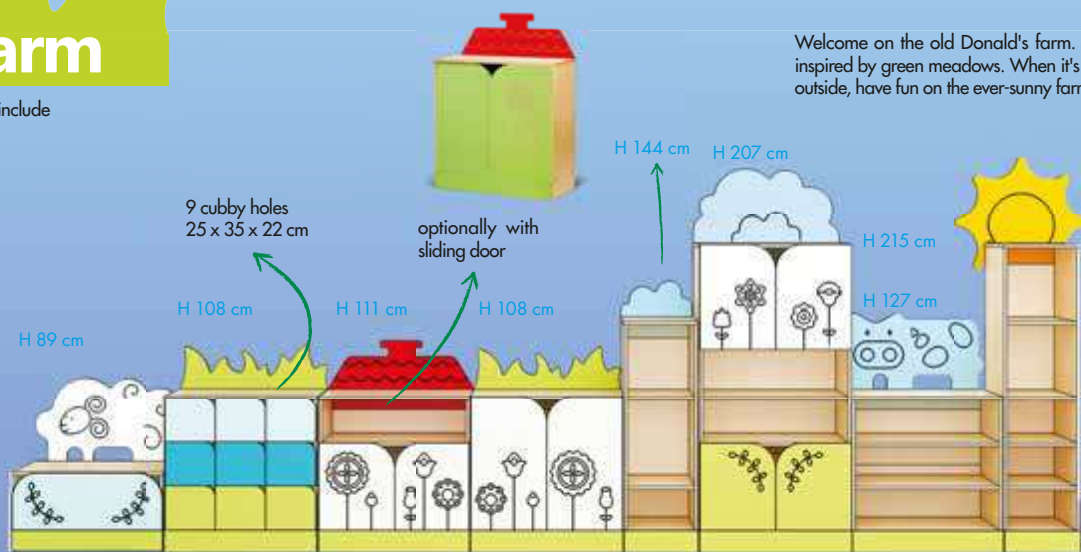

Welcome on the old Donald's farm. The collection is inspired by green meadows. When it's rainy and windy outside, have fun on the ever-sunny farm.

Children love animals and close contact with them. The new furniture series Fantasy is intended to meet these needs. The same size modules differ only in decorations on the fronts. A complement to the series is a teacher's desk. The furniture is ideal for day care centres and nursery schools by organizing functional space. With the wide range of modules,

interiors can be arranged so as to meet the needs of the youngest. The universal colour scheme makes a background for various decorations and accessories. The furniture comes in a set, but a particular piece can be bought separately. An interesting addition to the series of ten modules are soft foam discs with animal motifs matching those on the furniture.



**Flamingo Desk**  
**NS 2820**

- 120 x 52 x 76 cm



**Storage unit Crocodile**  
**NS 2811**

- 82 x 38 x 43 cm



**Shelving unit Toucan**  
**NS 2814**

- 41 x 38 x 125 cm



**Shelving unit Giraffe**  
**NS 2816**

- 41 x 38 x 166 cm



**Storage unit Baobab**  
**NS 2815**

- 82 x 38 x 166 cm

## Jungle





**Locker unit**

**Zebra**

**NS 2819**

- 82 x 38 x 84 cm
- 9 lockers, 22 x 25 cm



*sliding doors*

**Storage unit  
with sliding  
doors Monkey**

**NS 2818**

- 82 x 38 x 84 cm



**Storage unit  
Hippo**

**NS 2812**

- 82 x 38 x 84 cm



**Storage unit  
Elephant**

**NS 2813**

- 82 x 38 x 84 cm



**Shelving unit  
Lion**

**NS 2817**

- 82 x 38 x 84 cm



## Jungle seats

A set of light and functional foam poufs to complement our latest furniture line Jungle. At present we offer an armchair, a sofa and a cube which are great to fill space.

Made of high-quality microfibre-covered foam. All pieces have easy-to-clean zipped covers.





**Armchair** **NS 2205**

- 50 x 76 x 42 cm, seat height 25 cm



**Cube** **NS 2206**

- 42 x 42 x 38 cm



**Sofa** **NS 2204**

- 38 x 42 x 50 cm, seat height 25 cm



**Jungle seats**

**NS 2200**

- 8 seats with different printed animals
- pVC cover
- fit the container on casters
- ø 35 H 3 cm



**Jungle Sensory Board**

**NS 0893**

A board with sensory elements: a monkey with a fluffy tummy, a lion with a mane, elephant's skin, tree bark, grainy soil.

- 119 x 76.5 cm





**Storage unit Dragon**  
NS 2889

• 82 x 38 x 84 cm



**Shelving unit Knight**  
NS 2892

• 41 x 38 x 125 cm



**Shelving unit Prince**  
NS 2893

• 41 x 38 x 166 cm



**Storage unit Castle**  
NS 2891

• 82 x 38 x 166 cm



Royal





**Little Red Riding Hood**  
NS 2890

- 82 x 38 x 84 cm



**Shelving unit Princess**  
NS 2894

- 82 x 38 x 84 cm



**Locker unit Farm**  
NS 2856

- 82 x 38 x 84 cm
- 9 lockers, 22 x 25 cm



**Storage unit Sprites**  
NS 2888

- 82 x 38 x 43 cm





**Storage unit - Submarine**  
NS 1848

• 82 x 38 x 43 cm



**Storage unit Wave**  
NS 1849

• 82 x 38 x 84 cm



**Little Whale**  
NS 1851

• 41 x 38 x 125 cm



**Blue Cloud**  
NS 1853

• 41 x 38 x 166 cm



**Storage unit Lighthouse**  
NS 1852

• 82 x 38 x 166 cm







**Storage unit Whale**  
**NS 1850**

- 82 x 38 x 84 cm



**Storage unit with sliding doors**  
**NS2875**

- 82 x 35,5 x 84,5 cm.



**Locker unit Wave**  
**NS 2876**

- 82 x 38 x 84 cm
- 9 lockers, 22 x 25 cm



**Shelving unit Blue Wave**  
**NS 1854**

- 82 x 38 x 84 cm



**Wave**

# Farm



**Storage unit Lamb**  
**NS 1868**

• 82 x 38 x 43 cm

**Storage unit House**  
**NS 1869**

• 82 x 38 x 84 cm



**Shelving unit Cow**  
**NS 1874**

• 82 x 38 x 84 cm



**Storage unit Grass**  
**NS 1870**

• 82 x 38 x 84 cm



**Shelving unit Cloud**  
**NS 1871**

• 41 x 38 x 125 cm



**Shelving unit Sun**  
**NS 1873**

• 41 x 38 x 166 cm



**Storage unit Cloud**  
**NS 1872**

• 82 x 38 x 166 cm



**Locker unit Farm**  
**NS 2856**

• 82 x 38 x 84 cm



**Unit with sliding doors**  
**NS 2855**

• 82 x 35 x 84 cm.

## Wave

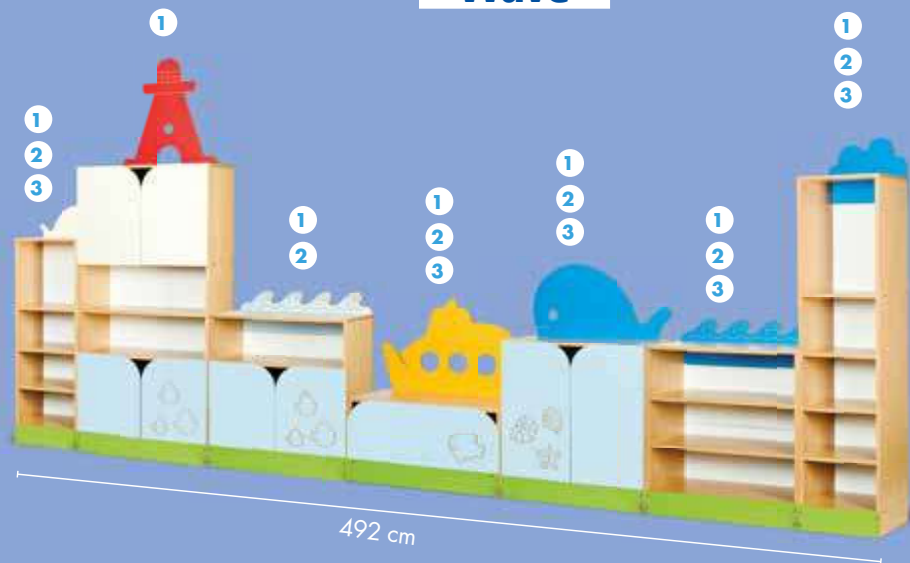

**SET 1 NS 1845**  
total length: 492 cm

- NS 1848
- NS 1849
- NS 1850
- NS 1851
- NS 1852
- NS 1853
- NS 1854



**SET 2 NS 1846**  
total length: 369 cm

- NS 1848
- NS 1849
- NS 1850
- NS 1853
- NS 1854



**SET 3 NS 1847**  
total length: 287 cm

- NS 1848
- NS 1850
- NS 1853
- NS 1853

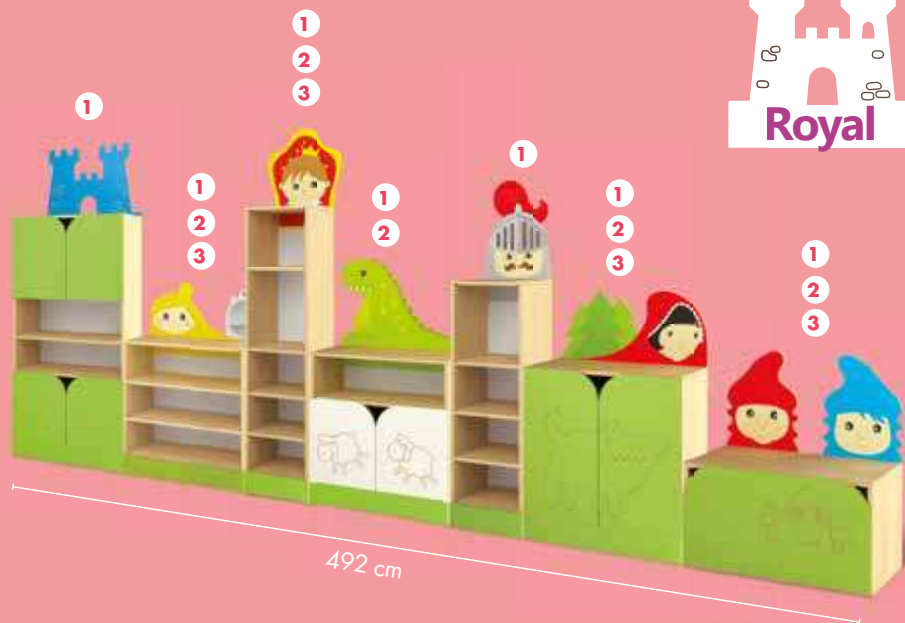

**SET 1 NS 2885**  
total length: 492 cm

- NS 2888
- NS 2889
- NS 2890
- NS 2891
- NS 2892
- NS 2893
- NS 2894



**SET 2 NS 2886**  
total length: 369 cm

- NS 2888
- NS 2889
- NS 2890
- NS 2893
- NS 2894



**SET 3 NS 2887**  
total length: 287 cm

- NS 2888
- NS 2890
- NS 2893
- NS 2894

# Farm



## SET 1 NS 1865

total length: 492 cm

- NS 1868
- NS 1869
- NS 1870
- NS 1871
- NS 1872
- NS 1873
- NS 1874



## SET 2 NS 1866

total length: 369 cm

- NS 1868
- NS 1869
- NS 1870
- NS 1873
- NS 1874



## SET 3 NS 1867

total length: 287 cm

- NS 1868
- NS 1870
- NS 1873
- NS 1874

# Jungle

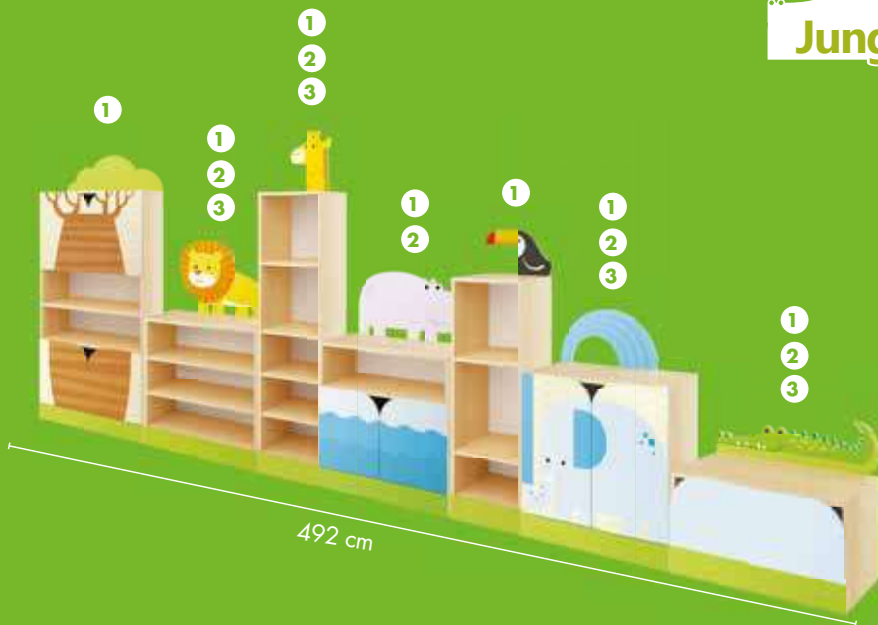

## SET 1 NS 2800

total length: 492 cm

- NS 2815
- NS 2817
- NS 2816
- NS 2812
- NS 2814
- NS 2813
- NS 2811



## SET 2 NS 2801

total length: 369 cm

- NS 2816
- NS 2817
- NS 2812
- NS 2813
- NS 2811



## SET 3 NS 2802

total length: 287 cm

- NS 2816
- NS 2817
- NS 2813
- NS 2811



# cuboo

The Cubo series combines functionality and individual character within the classic style. The furniture is notable for its original design and lightness of its shapes. You can create unique arrangements of elements, sets, accessories and colours according to your taste. With this diversity of solutions, the product is particularly useful in classrooms. The shapes have been designed so that their spacious insides are always easily accessible.

- 23 sets in various dimensions

#### accessories:

- 4 types of top add-ons
- 76 x 40 x 37 cm,
- 76 x 40 x 75 cm)
- 2 types of shelves: narrow (35 x 36 cm) and wide (73 x 36 cm)
- 2 types of cubby holes: narrow and wide
- 3 types of bins:
- small (37 x 36 x 34 cm),
- medium (74 x 36 x 34 cm)
- and large (112 x 36 x 34 cm)
- 3 door sizes (either swing direction; 37 x 37 cm,
- 37 x 74 cm, 37 x 112 cm)
- 4 types of drawers:
- narrow (37 x 37 x 18 cm),
- wide (74 x 37 x 37 cm),
- deep (37 x 37 x 37 cm),
- shallow (74 x 37 x 15 cm)
- ergonomic plastic handles
- laminated board body in birch finish
- fronts of drawers, doors, chests, cubby holes in 5 colours: blue, white, grey, yellow, green
- all accessories (bins, decorative back panels, doors)
- sold separately

body

birch

laminated board

fronts

MDF

# CREATE YOUR OWN UNIQUE COMBINATIONS

## UNIT 3

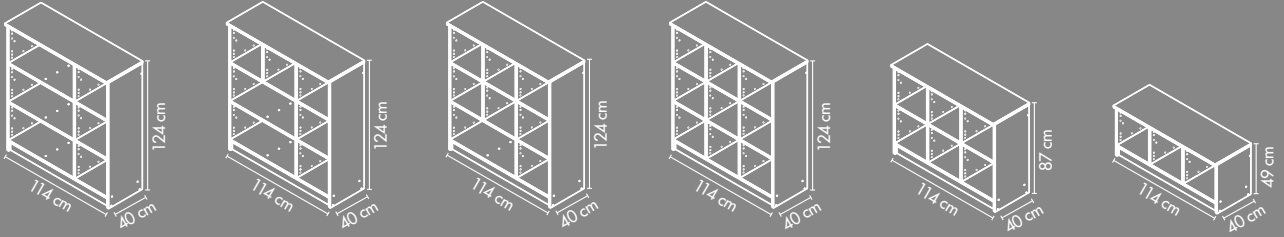

## UNIT 2

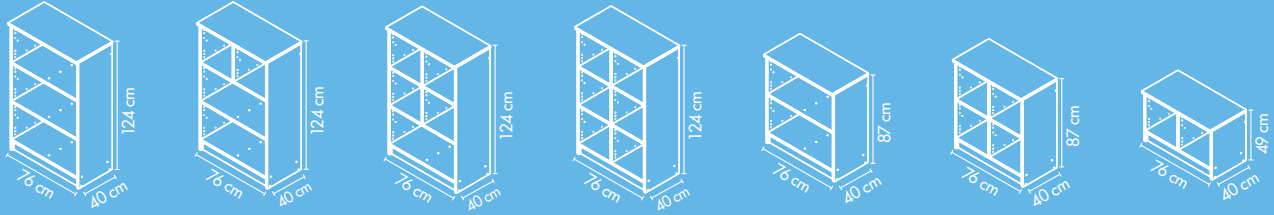

## UNIT 1

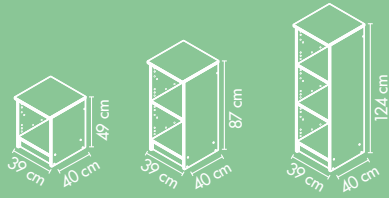

## ADD-ON 2

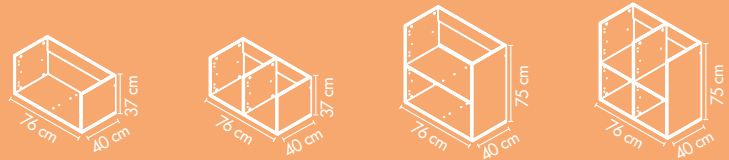

## FOR CONTAINERS

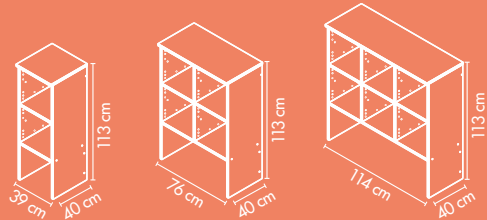

## ACCESSORIES

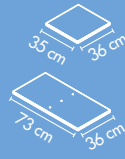

## DOORS

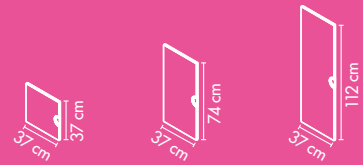

## DRAWERS



## CONTAINERS

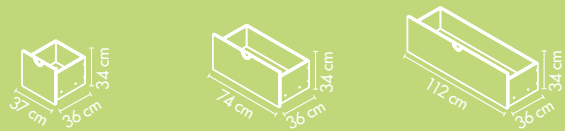



# FEATURES

**!** all accessories - bins, decorative panels, doors - sold separately



drawers, bins and doors available in 5 colours

23 basic modules

4 types of top add-ons for 2-column units

ergonomic plastic handles

2 shelf types: wide and narrow

low drawer: 35 x 36 x 36 cm  
tall drawer: 73 x 36 x 36 cm

containers on castors

3 door sizes (either swing direction)

4 drawer types: narrow, wide, deep and shallow

# BASIC MODULES



## UNIT 2



Small 2  
NC 2101



Medium 4  
NC 2201



Medium 2s  
NC 2221



Tall 6  
NC 2301



Tall 4+1s  
NC 2311



Tall 2+2s  
NC 2321



Tall 3s  
NC 2331

## ADD-ON + ANY UNIT 2 = EVEN MORE NEW ARRANGEMENTS



Tall 4  
NC 0501



Tall 2s  
NC 0521



Low 2  
NC 0401



Low 1s  
NC 0411

**!** These units are NOT freestanding and needs to be attached to another piece of furniture (Unit 2).



+

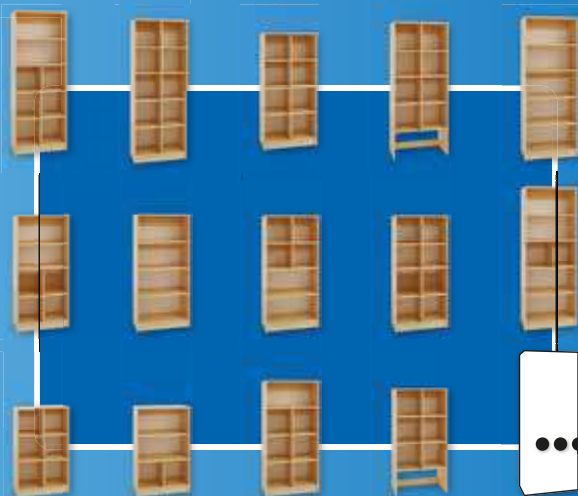

**32 POSSIBILITIES**

## UNIT 1



Small 1  
NC 1101



Medium 2  
NC 1201



Tall 3  
NC 1301

## FOR CONTAINERS



Small 2  
NC 1261



Medium 4  
NC 2261



Tall 6  
NC 3261

## UNIT 3



Small 3  
NC 3101



Medium 6  
NC 3201



Tall 9  
NC 3301

## ACCESSORIES ON PAGE 54



Tall 7+1s  
NC 3311



Tall 5+2s  
NC 3321

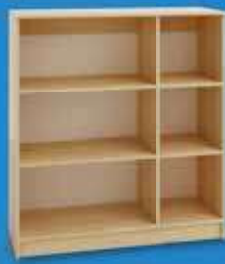

Tall 3+3s  
NC 3331





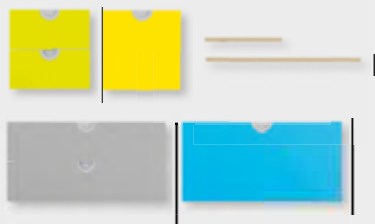

+

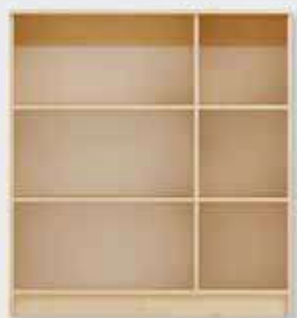

↓



# ACCESSORIES

With drawers and shelves of various types and sizes configurations get multiplied



fronts available in 5 colours

## SHELVES AND DRAWERS



**narrow low**  
• 2 pcs.



**narrow tall**  
• 1 pc.



**wide low**  
• 2 pcs.



**wide tall**  
• 1 pc.

○ NC 0013	○ NC 0023	○ NC 0033	○ NC 0043
● NC 0012	● NC 0022	● NC 0032	● NC 0042
● NC 0015	● NC 0025	● NC 0035	● NC 0045
● NC 0016	● NC 0026	● NC 0036	● NC 0046
● NC 0014	● NC 0024	● NC 0034	● NC 0044

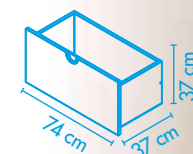
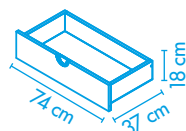
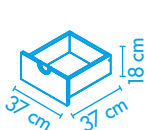

**Small shelf**  
**NC 0051**  
• 35 x 36 cm



**Large shelf**  
**NC 0061**  
• 73 x 36 cm





# ACCESSORIES

More options available with doors and containers of various sizes.

cuboo





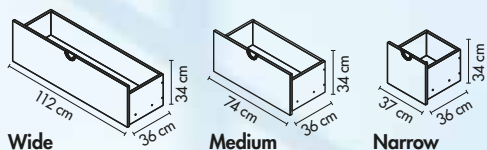

**Wide**

• 1 pc

**Medium**

• 1 pc

**Narrow**

• 1 pc

## CONTAINERS ON CASTORS



- NC 9103
- NC 9102
- NC 9105
- NC 9106
- NC 9104



- NS 9203
- NS 9202
- NC 9205
- NC 9206
- NC 9204



- NC 9303
- NC 9302
- NC 9305
- NC 9306
- NC 9304

## DOORS



**Tall**

• 112 x 37 cm  
• 1 pc



**Medium**

• 74 x 37 cm  
• 1 pc



**Low**

• 37 x 37 cm  
• 1 pc

- |           |           |           |
|-----------|-----------|-----------|
| ● NC 0093 | ● NC 0083 | ● NC 0073 |
| ● NC 0092 | ● NC 0082 | ● NC 0072 |
| ● NC 0095 | ● NC 0085 | ● NC 0075 |
| ● NC 0096 | ● NC 0086 | ● NC 0076 |
| ● NC 0094 | ● NC 0084 | ● NC 0074 |



# READY FURNITURE

**Modul 1**

ZC 1100 39 x 40 x 49 cm



**Modul 2**

ZC 1200 39 x 40 x 97 cm



**Modul 3**

ZC 1300 39 x 40 x 124 cm



**Modul 7**

ZC 2200 76 x 40 x 87 cm



**Modul 8**

ZC 2201 76 x 40 x 87 cm



**Modul 9**

ZC 2300 76 x 40 x 124 cm



**Modul 10**

ZC 2301 76 x 40 x 124 cm



**Modul 6**

ZC 2602 76 x 40 x 113 cm



**Modul 11**

ZC 2302 76 x 40 x 124 cm



**Modul 4**

ZC 2600 76 x 40 x 113 cm



**Modul 5**

ZC 2601 76 x 40 x 113 cm



**Modul 17**

ZC 3601 114 x 40 x 113 cm



**Modul 12**

ZC 2500 76 x 40 x 199 cm



**Modul 13**

ZC 2501 76 x 40 x 199 cm



**Desk**

BC 0001 115 x 48 x 77,5 cm



**Modul 19**

ZC 3602 114 x 40 x 113 cm





**Modul 14**

ZC 3100 114 x 40 x 49 cm



**Modul 15**

ZC 3200 114 x 40 x 87 cm

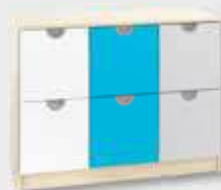

**Modul 16**

ZC 3201 114 x 40 x 87 cm



**Modul 18**

ZC 3300 114 x 40 x 113 cm



**Modul 21**

ZC 3301 114 x 40 x 124 cm

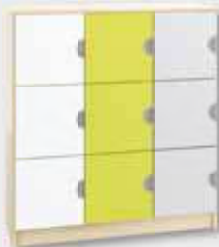

**Modul 22**

ZC 3302 114 x 40 x 124 cm



**Modul 23**

ZC 3303 114 x 40 x 124 cm



**Modul 20**

ZC 3600 114 x 40 x 124 cm



# SETS

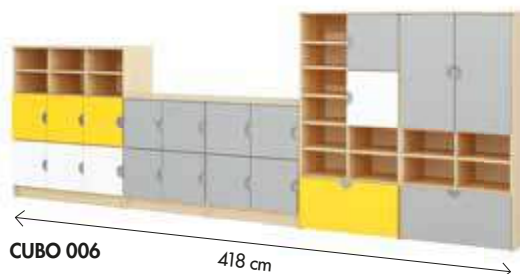
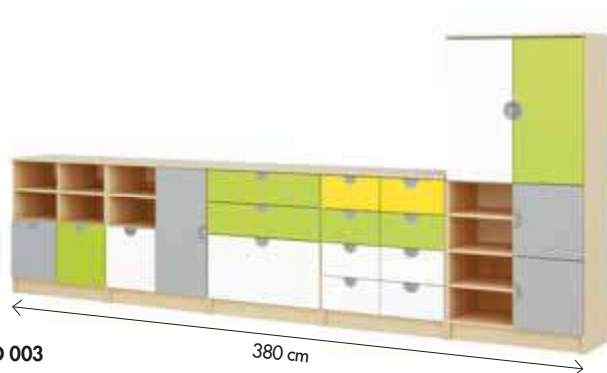
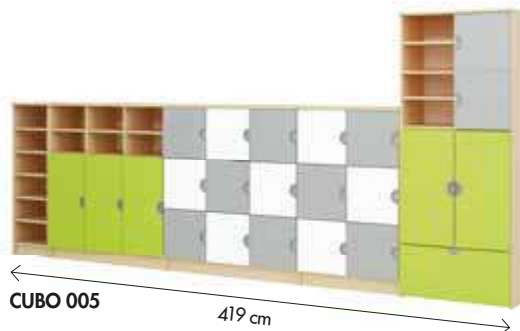
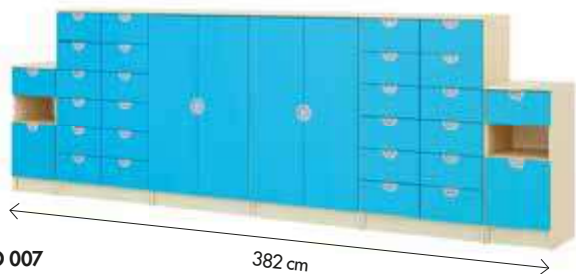
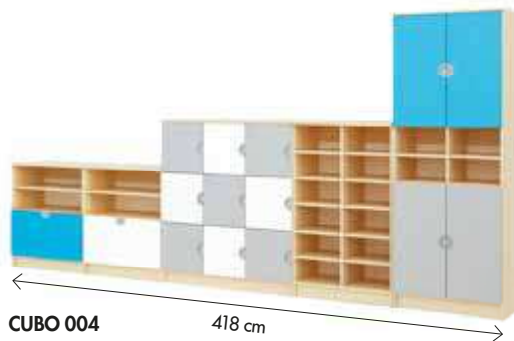
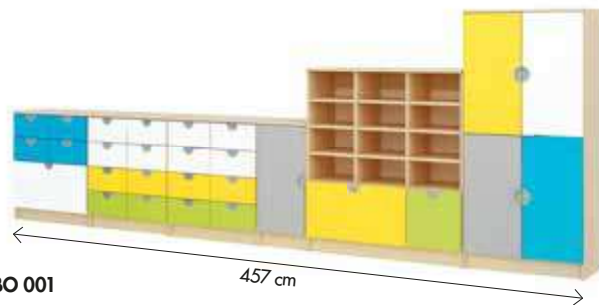





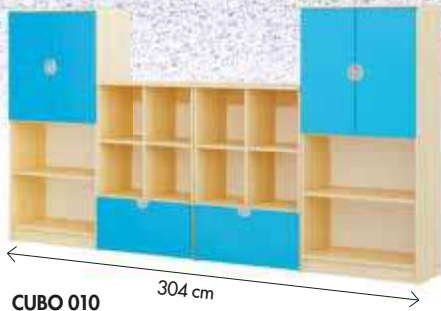

**CUBO 010**

304 cm



**CUBO 009**

532 cm

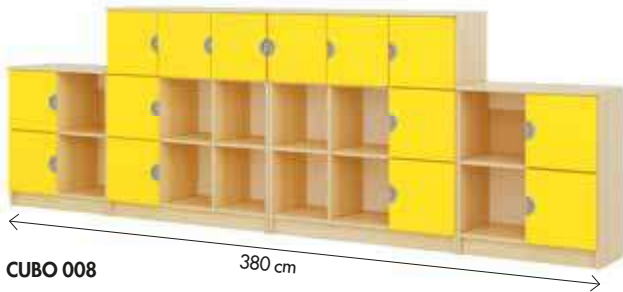

**CUBO 008**

380 cm

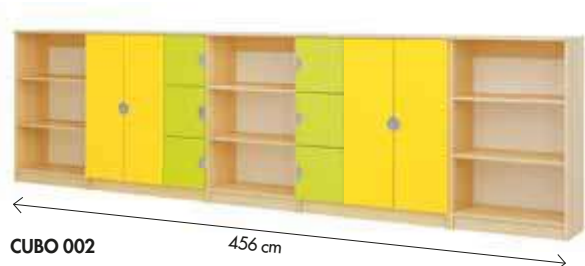

**CUBO 002**

456 cm





# RAINBOW

Rainbow. Functional and convenient lockers, easily assignable to every child in the group. Doors in pastel rainbow colours. The colour scheme helps each child to find their own box. Each locker has a shelf inside. – Sold as a complete set.

body birch laminated board



fronts mdf

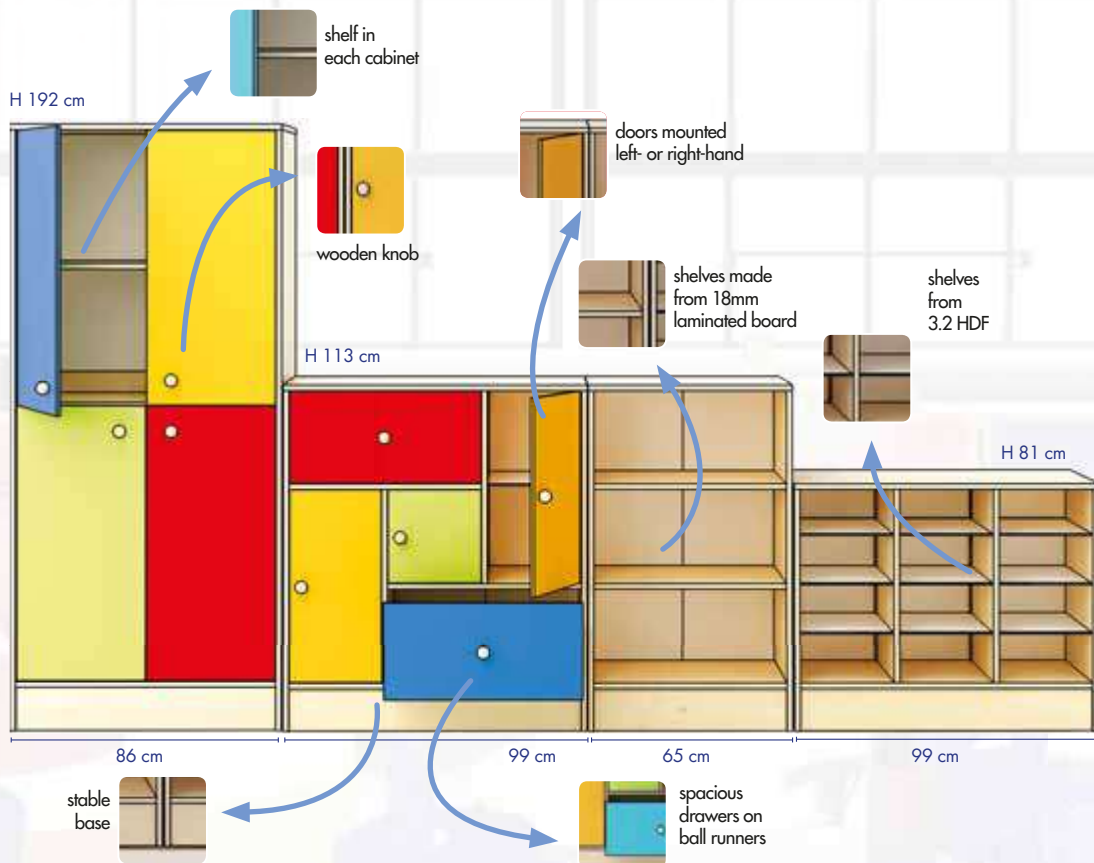

Doors mounted  
left- or right-hand

Round wooden  
knob

HDF shelf in  
each cube

Cube  
30 x 32 x 30 cm

**Big Module**

**NS 0468**

- 9 cubes, 18 shelves
- 99 x 35 x 112 cm





**Module 3**  
**NS 0468/D**

- 3 lockers with shelves and 2 drawers
- 99 x 35 x 113 cm



**Big Module**  
**NS 0468**

- 9 lockers with shelves
- 99 x 35 x 112 cm



**Module 4**  
**NS 0468/E**

- 3 lockers with shelves and 3 drawers
- 99 x 35 x 113 cm



**Module 2**  
**NS 0468/C**

- 6 lockers with shelves
- 99 x 35 x 113 cm



**Small Module**  
**NS 0469**

- 6 lockers with shelves
- 66,5 x 35 x 112 cm

**Module 1**  
**NS 0468B**

- 6 lockers with shelves
- 99 x 35 x 81 cm



**Tall cabinet with shelves**  
**NS 1468**

- 86 x 35 x 192 cm; 4 shelves



**Module 7**

**NS 0468/H**

• 99 x 35 x 113 cm



**Module 8**

**NS 0468/I**

• 65 x 35 x 113 cm



**Module 6**

**NS 0468/G**

• 99 x 35 x 81 cm



**Module B**

**NS 0469/2**

• 99 x 35 x 113 cm



**Module A**

**NS 0469/1**

• 65 x 35 x 113 cm



**Module C**

**NS 0469/3**

• 99 x 35 x 81 cm

**Beech libraries are  
available on page 142**





 **RAINBOW**

Series in pastel colours

The collection consists of several modules for unrestricted space arrangement according to current needs and trends. The framework is made of laminated birch-effect board with MDF backs and fronts in blue, sky blue, light green and beige.

The series includes:

- a large module (9 storage cubes with shelves) 99 cm x 35 cm x 112 cm
- a small module (6 storage cubes with shelves) 66.5 cm x 35 cm x 112 cm
- module1 (6 storage cubes with shelves) 99 cm x 35 cm x 81 cm
- module2 (6 storage cubes with shelves) 99 cm x 35 cm x 113 cm
- module3 (6 storage cubes with shelves and 2 drawers) 99 cm x 35 cm x 113 cm
- module4 (3 storage cubes with shelves and 3 drawers) 99 cm x 35 cm x 113 cm
- a tall cabinet with shelves (4 drawers) 86 cm x 40 cm x 192 cm

fronts



mdf

body

birch  
laminated board



features

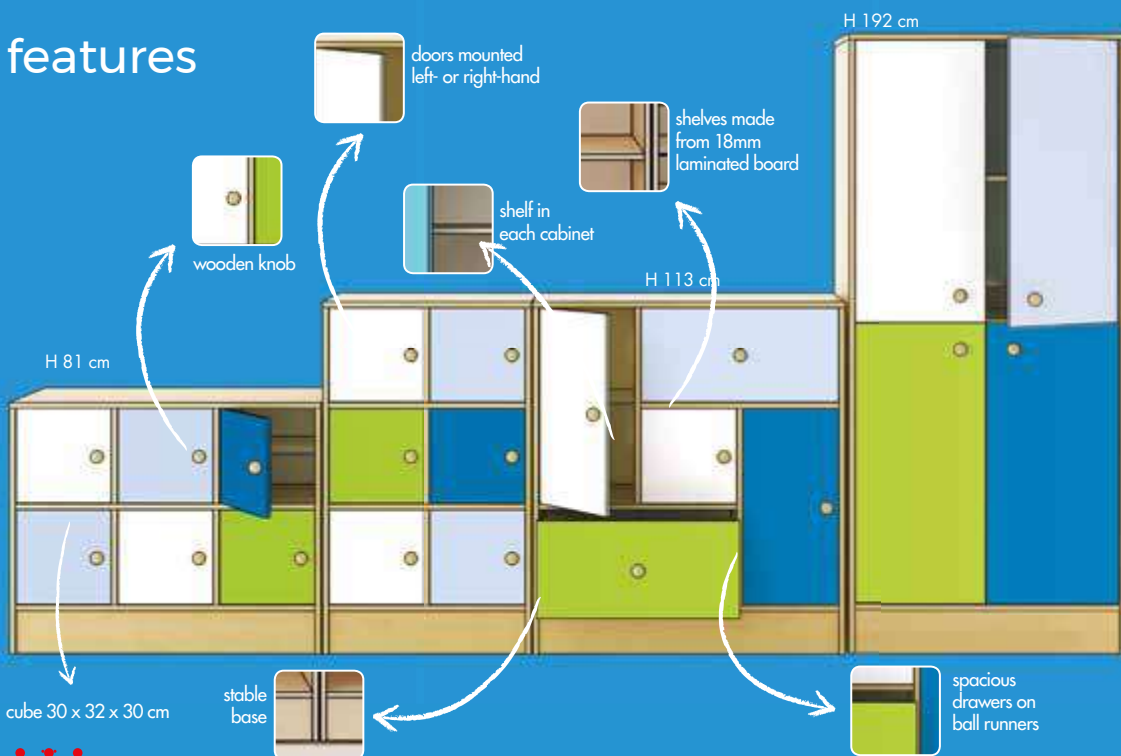

# PASTEL



# PASTEL



shelves are on page 64



cube  
30 x 32 x 30 cm



**Module 1**  
**NP 3201**

- 99 x 35 x 81 cm
- 6 lockers with shelves

**Small module**  
**NP 2301**

- 65 x 35 x 113 cm
- 6 lockers with shelves

**Tall cabinet**  
**NP 6001**

- 86 x 40 x 192 cm; 4 shelves





**Module 2**  
**NP 3361**

- 99 x 35 x 113 cm
- 6 lockers with shelves



**Module 4**  
**NP 3331**

- 99 x 35 x 113 cm
- 3 lockers with shelves and 3 drawers



**Module 3**  
**NP 3391**

- 99 x 35 x 113 cm
- 3 lockers with shelves and 2 drawers



**Big module**  
**NP 3301**

- 99 x 35 x 113 cm
- 9 lockers with shelves

# CLASSICAL



body beech  
laminated board

fronts and decorations  
mdf

trays  
cardboard and wooden



A proven and recognized line of furniture. It is very functional and allows unlimited combinations of colour arrangements, as well as a large display area. The containers, drawers and boxes help children to sort their school utensils and keep them tidy. Arranging a safe and comfortable interior is easier thanks to the wide variety of units and accessories.

Five heights: 54, 74, 93, 112, 131 cm

Types of units available:

- with trays,
- with shelves,
- with trays and containers,
- with shelves and containers,
- with shelves and trays,
- with shelves + trays and containers,
- with compartments,
- with compartments and containers,
- corner and inside corner,
- tall storage units,
- bookcases.

Decorative boards.

The colourful boards will enliven every nursery classroom. The variety of colours and shapes stimulates children's imagination and encourages them to play on the surface of the furniture.

Extras (sold separately):

- doors,
  - decorative boards,
  - containers,
  - shallow and deep wooden trays — 4 colours,
  - shallow and deep cardboard trays — 4 colours,
  - EKO shallow and deep cardboard trays.
- for trays, only we recommend NS 0716 runners. The arrangements shown are only examples.

Thanks to their construction, cardboard trays hold a weight of up to 42 kgs, while remaining light and safe for children.

Cardboard and wooden trays, which come in various colours, are aesthetic and very durable. Their dimensions fit the Classical series.

All the elements are sold separately.



S

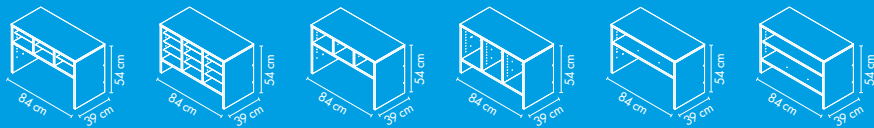

M

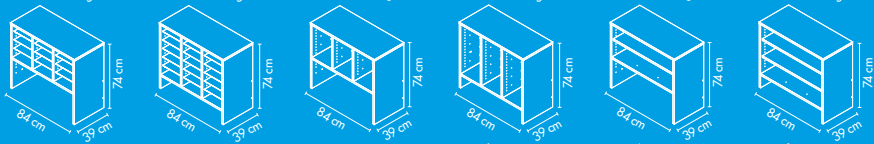

L

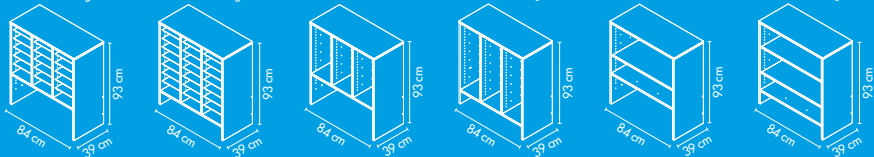

X

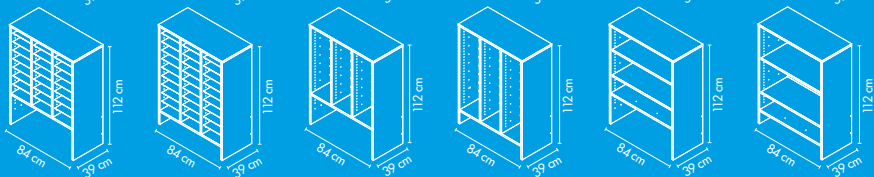

XL

UNITS 84cm

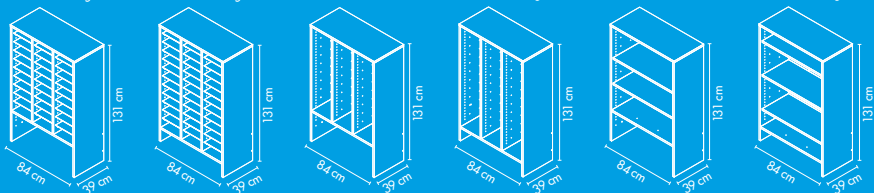

UNITS 112cm

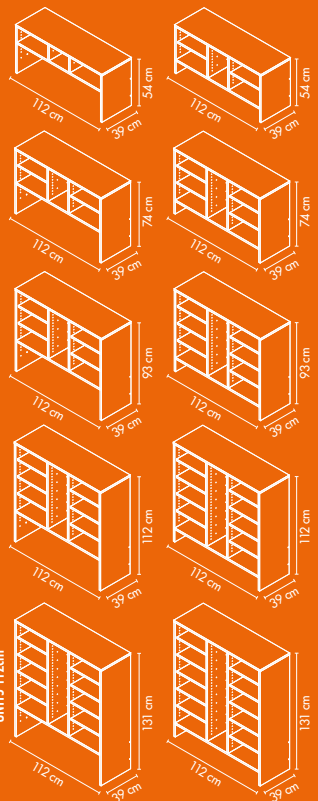

## CLASSICAL SERIES FURNITURE

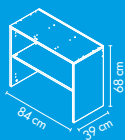

TALL SHELVING UNITS AND ADD-ON

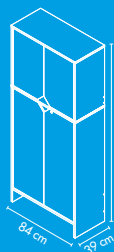

S

CORNER UNITS

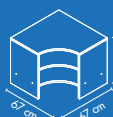

L



M



X



XL



CORNER UNITS

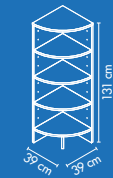
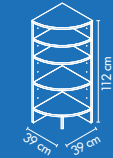
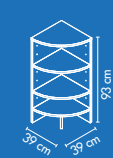

# CLASSICAL

## FEATURES

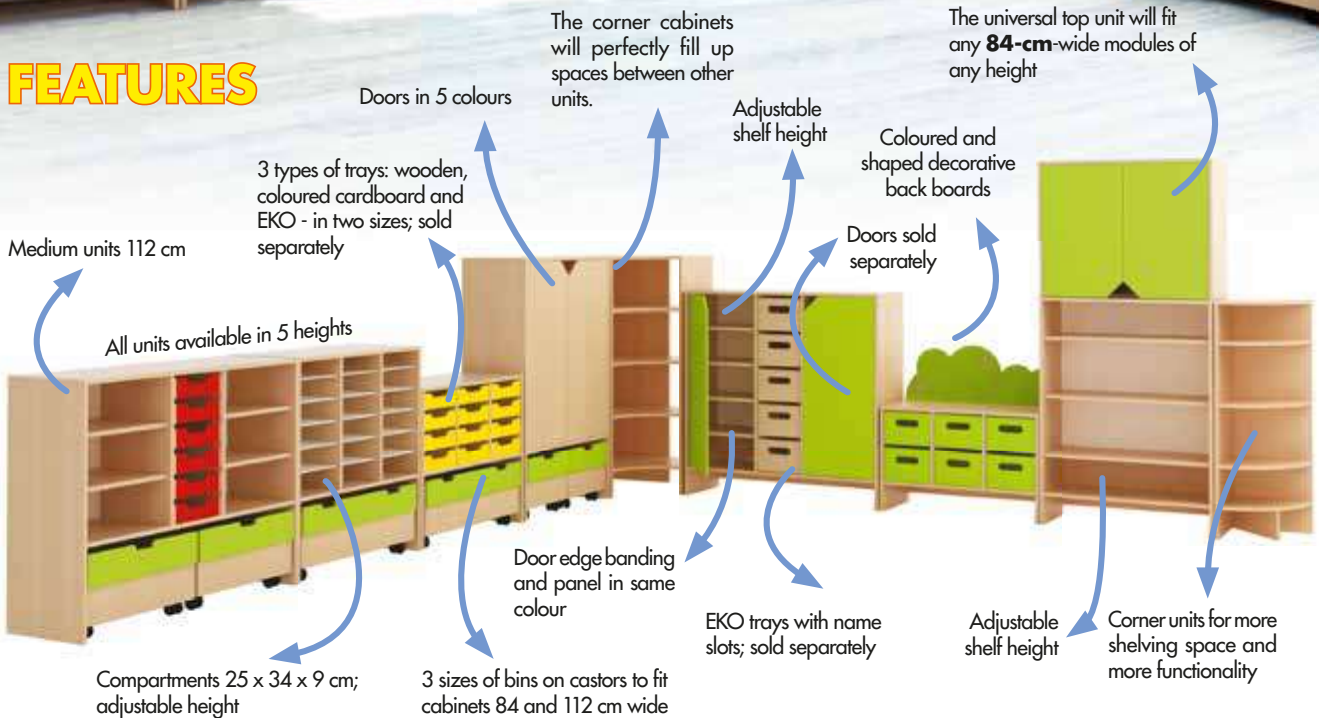



**S**

**NW 0801**

sold with  
6 runners



**M**

**NW 0802**

sold with  
12 runners



**L**

**NW 0803**

sold with  
18 runners



**X**

**NW 0804**

sold with  
24 runners



**XL**

**NW 0805**



## STORAGE UNITS 84CM

- each 84cm cabinet can be extended with a top unit.
- boxes are sold separately.
- doors cannot be mounted on the cabinets.
- all accessories, such as the top unit, boxes and trays, are available separately.



## FOR TRAYS & CONTAINERS

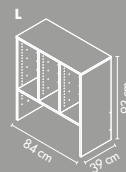
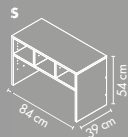



for full offer of trays, containers and additional runners see page 90 – 92



## FOR TRAYS

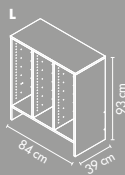
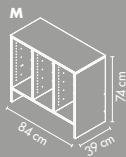
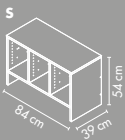

sold with  
6 runners



**S**  
NW 0701

sold with  
12 runners



**M**  
NW 0702

sold with  
18 runners



**L**  
NW 0703

sold with  
24 runners



**X**  
NW 0704

sold with  
30 runners



**XL**  
NW 0705

## STORAGE UNITS 84CM

- each 84cm cabinet can be extended with a top unit.
- boxes are sold separately.
- all accessories, such as the top unit, boxes and trays, are available separately.



for full offer of trays, containers and additional runners see page 90 – 92



## WITH SHELVES

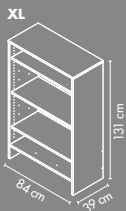
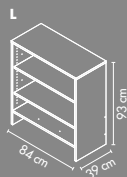
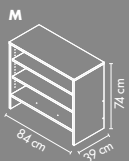
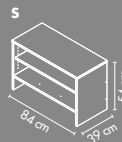

**S**  
NW 0711



**M**  
NW 0712



**L**  
NW 0713



**X**  
NW 0714



**XL**  
NW 0715

## WITH SHELVES & FOR CONTAINERS

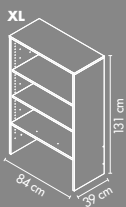
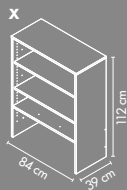
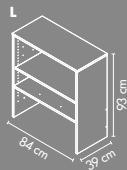
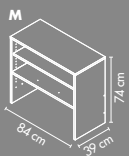
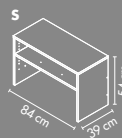

cabinet incompatible  
with doors

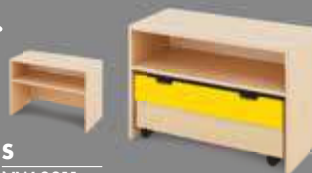

**S**  
NW 0811



**M**  
NW 0812



**L**  
NW 0813



**X**  
NW 0814



**XL**  
NW 0815

## STORAGE UNITS 84CM

- each 84cm cabinet can be extended with a top unit.
- boxes are sold separately.
- doors cannot be mounted on the cabinets.
- all accessories, such as the top unit, boxes and trays, are available separately.



## WITH COMPARTMENTS

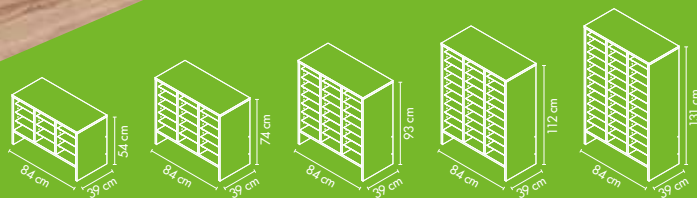

# WITH COMPARTMENTS & FOR CONTAINERS

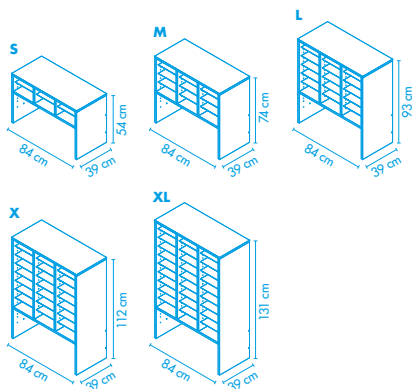

**!** for full offer of trays, containers and additional runners see page 90 – 92

The compartments will make a perfect storage place for children's artwork, drawing paper or games. If necessary, they will also hold shallow trays for bits and pieces. With this type of cabinet, each child will have their own shelf. Version X provides 24 compartments, version XL - 30.



**S**  
NW 0831

**M**  
NW 0832



**L**  
NW 0833

**X**  
NW 0834

**XL**  
NW 0835



**S**  
NW 0731

**M**  
NW 0732

**L**  
NW 0733

**X**  
NW 0734

**XL**  
NW 0735



# STORAGE UNITS 112CM

- boxes are sold separately.
- doors cannot be mounted on cabinet NW 0821
- all accessories, such as the top unit, boxes and trays, are available separately.



## WITH SHELVES, TRAYS & CONTAINERS

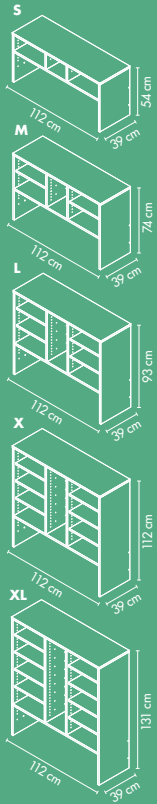

sold with  
6 runners



**X**  
NW 0824



Unit not compatible  
with doors



**S**  
NW 0821

sold with  
2 runners



**M**  
NW 0822

sold with  
4 runners



**L**  
NW 0823

sold with  
8 runners



**XL**  
NW 0825

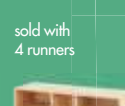



for full offer of trays, containers and additional runners see page 90 – 92

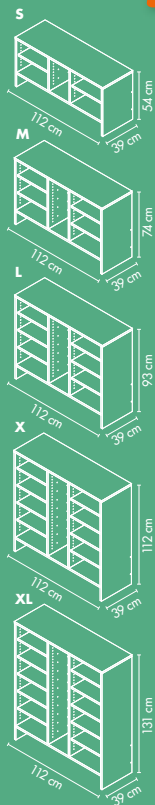

## WITH SHELVES & FOR TRAYS

sold with  
8 runners



**X**  
NW 0724

sold with  
10 runners



**XL**  
NW 0725

sold with  
2 runners



**S**  
NW 0721

sold with  
4 runners



**M**  
NW 0722

sold with  
6 runners



**L**  
NW 0723

# CLASSICAL



for full offer of tables and chairs see  
pages from 156 to 189





## Add-on

Each 84 cm cabinet can be extended with this unit.

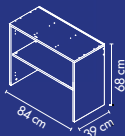

### Add-on

#### NW 0001

- 84 x 39,5 x 65,5 cm
- doors sold separately

**!** NOT A STANDALONE UNIT  
functional only with a base unit  
undereath



- |                  |                   |
|------------------|-------------------|
| ● NW 0463 green  | ● NW 0463Z green  |
| ● NW 0461 red    | ● NW 0461Z red    |
| ● NW 0464 yellow | ● NW 0464Z yellow |
| ● NW 0462 blue   | ● NW 0462Z blue   |
| ● NW 0526 beech  | ● NW 0526Z beech  |

### Doors for add-on

- 49,5 x 69 cm



### Doors for add-on

- 49,5 x 69 cm, with lock

**!** All accessories, such as the top unit, boxes and trays, are available separately.

## HOW DOES ADD-ONS WORK?



The idea is to increase the usable space of the series. It can be mounted on all 84 cm cabinets.

Thanks to the variety of unit types and accessories numerous combinations are possible.

BASE FURNITURE WITH ACCESSORIES

BASE FURNITURE WITH ACCESSORIES AND ADD-ON







**XL** NW 0765



**X** NW 0764



**L** NW 0763



**M** NW 0762



**S** NW 0761



**XL** NW 0755



**X** NW 0754



**L** NW 0753



**M** NW 0752



**S** NW 0751



## INSIDE CORNER SHELVING UNIT

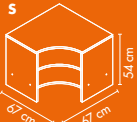

## CORNER SHELVING UNIT

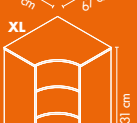

# TALL STORAGE

## BODY

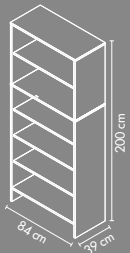

NW 8004

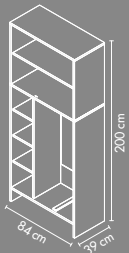

NW 0718U

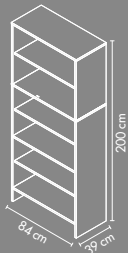

NW 8002

## DOORS

Beech

ZI

NI

ZL

CZ

Doors available in colours

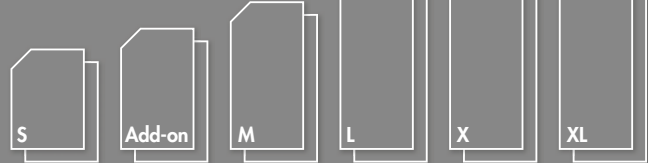

NW 0718U

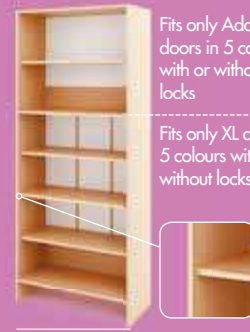
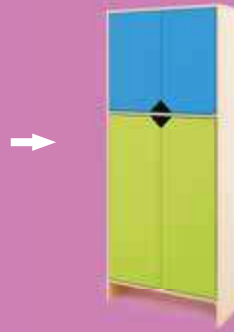

NW 8004



NW 8002

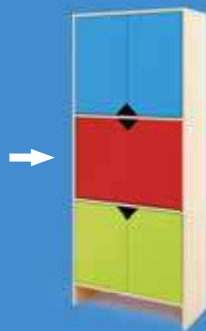
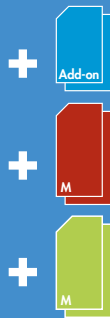

## EXAMPLES

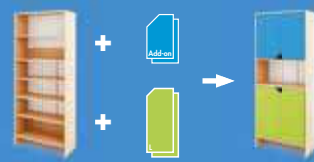
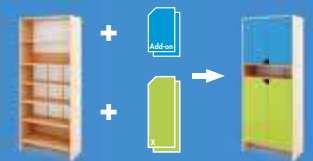
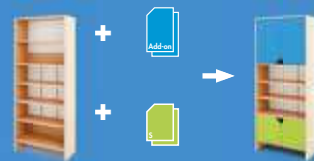

# TALL STORAGE



! for full offer of trays, containers and additional runners see page 90 – 92



## CONTAINERS

beech\* red blue green yellow  
 available in colours \*does not apply to containers

Large container  
 for 84<sup>cm</sup> units

• 77 x 35 x 30 cm

Medium container  
 for 112<sup>cm</sup> units

• 53 x 35 x 30 cm

Small container  
 for 84<sup>cm</sup> units

• 35 x 35 x 30 cm

● NW 0611	NW 0621	NW 0631 red
● NW 0612	NW 0622	NW 0632 blue
● NW 0613	NW 0623	NW 0633 green
● NW 0614	NW 0624	NW 0634 yellow

## DOORS

sold in 2 pcs. set



S	M	L	X	XL	doors dim.
40 x 36cm	40 x 55cm	40 x 75cm	40 x 94cm	40 x 113cm	
● NW 0411	NW 0421	NW 0431	NW 0441	NW 0451	red
● NW 0412	NW 0422	NW 0432	NW 0442	NW 0452	blue
● NW 0413	NW 0423	NW 0433	NW 0443	NW 0453	green
● NW 0414	NW 0424	NW 0434	NW 0444	NW 0454	yellow
● NW 0521	NW 0522	NW 0523	NW 0524	NW 0525	beech



All doors available  
 in version with lock.  
 To order ones with lock add  
 „Z” to code. Ex. NW 0411Z



Eco-friendly light and robust cardboard trays in natural colour and with name slots.

**Cardboard Shallow 12**  
**NS 0717**

- 12 pcs., 35 x 25 x 8 cm

**Cardboard Deep 8**  
**NS 0718**

- 8 pcs., 35 x 25 x 17 cm

**Wooden Deep**

- NS 7914 yellow
  - NS 7913 green
  - NS 7912 blue
  - NS 7911 red
  - NS 7910 beech
- 35 x 25 x 17 cm

**Wooden Shallow**

- NS 7934 yellow
  - NS 7933 green
  - NS 7932 blue
  - NS 7931 red
  - NS 7930 beech
- 35 x 25 x 8 cm

**Cardboard Shallow 12**  
**NS 1714**

- 12 pcs., 35 x 25 x 8 cm
- in 4 colours

**Cardboard Deep 8**  
**NS 1715**

- 8 pcs., 35 x 25 x 17 cm
- in 4 colours

**TRAYS**



available in colours

\*does not apply to containers

**Runners 12pcs.**  
**NS 0716**

- 12 pcs.
- 129cm



ultra  
**durable**  
cardboard trays  
**42 kg tested**



## DECORATIVE BOARDS

Their shapes and colours will enliven every room. They fit only 84 cm cabinets.

- W 84 cm

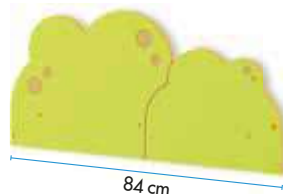

Tree  
NS 8107



Car  
NS 8106



Bear  
NS 8105



Fence  
NS 8104



Cat  
NS 8103

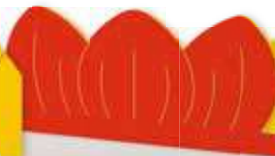

Tulip  
NS 8102



Sunflower  
NS 8100





## HANGING SHELF



**Hanging shelf**  
NS 0556

- 60 x 32 x 50 cm
- colour: beech

**Sunflower. Decorative board**  
NS 8109

- 60 x 34 cm

**Elephant. Decorative board**  
NS 8108

- 60 x 40 cm

# Seria +







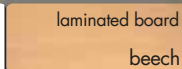
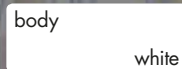

### CORNER UNITS

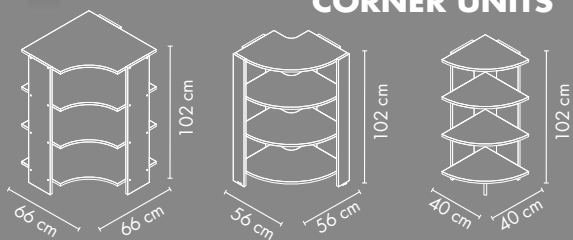

### CONNECTING UNITS

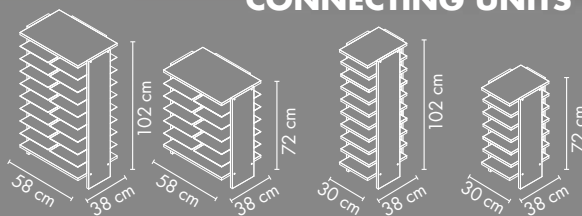

### SHELF UNITS

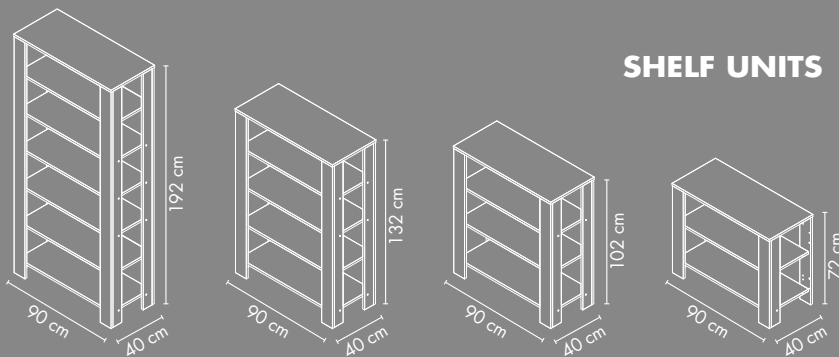

### STORAGE UNITS

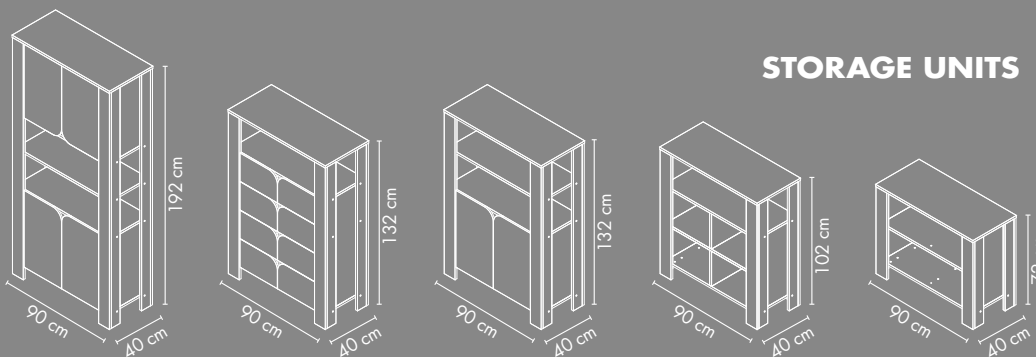

# Seria +

Bright, cheerful colour scheme. Ample space for storage and exposition, thanks to numerous drawers and shelves to store educational aids. With the elements, a child can create colourful arrangements of their own and use space creatively.

# STORAGE UNITS

open-frame, large-capacity, 4 heights



**Unit Mini**  
**NS 1667**

90 x 40 x 72 cm



**Unit Midi**  
**NS 1668**

90 x 40 x 102 cm

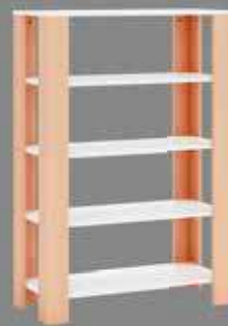

**Unit Maxi**  
**NS 1669**

90 x 40 x 132,5 cm



**Tall shelving unit**  
**NS 1684**

90 x 40 x 192 cm

**Seria +**





# SHELVING UNITS

spacious, handy, in 4 heights, with drawers or cabinets



**Unit with shelves**  
NS 1677

• 90 x 40 x 72 cm



**Unit with shelves and partition**  
NS 1676

• 90 x 40 x 102 cm

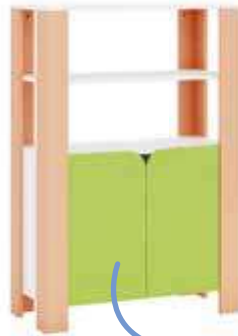

**Unit with doors**  
NS 1675

• 90 x 40 x 132,5 cm

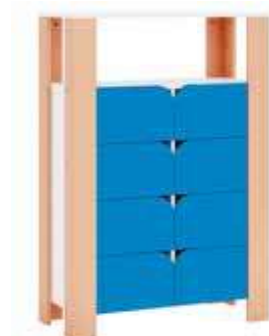

**Unit with drawers**  
NS 1674

• 90 x 40 x 132 cm

1 shelf inside



1 shelf inside

**Cabinet with doors**  
NS 1673

• 90 x 40 x 192 cm



# TRAYS

place for text



eco-friendly cardboard containers; natural colour, light and durable, with a name card slot.

## Cardboard Deep 8

NS 0718

- 35 x 25 x 17 cm, 8 pcs.

## Cardboard Shallow 12

NS 0717

- 35 x 25 x 8 cm, 12 pcs.

## Wooden Deep

NS 7914

NS 7913

NS 7912

NS 7911

NS 7910

- 35 x 25 x 17 cm

yellow

green

blue

red

beech

## Wooden Shallow

NS 7934

NS 7933

NS 7932

NS 7931

NS 7930

- 35 x 25 x 8 cm

yellow

green

blue

red

beech

## Cardboard Shallow 12

NS 1714

- 35 x 25 x 8 cm, 12 pcs.

- 4 colours

## Cardboard Deep 8

NS 1715

- 35 x 25 x 17 cm, 8 pcs.

- 4 colours

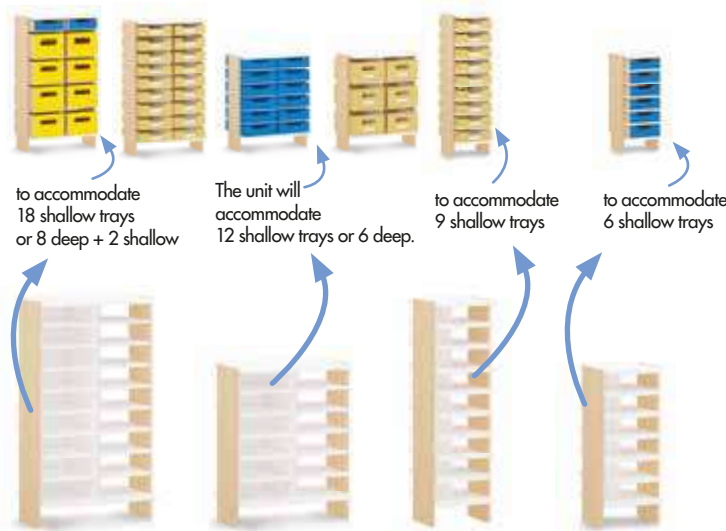

to accommodate  
18 shallow trays  
or 8 deep + 2 shallow

The unit will  
accommodate  
12 shallow trays or 6 deep.

to accommodate  
9 shallow trays

to accommodate  
6 shallow trays

## Tall wide

NS 1839

- 18 shelves,
- 58 x 38 x 102 cm

## Medium wide

NS 1840

- 12 shelves,
- 58 x 38 x 72 cm

## Tall narrow

NS 1841

- 9 shelves,
- 30 x 38 x 102 cm

## Medium narrow

NS 1842

- 6 shelves,
- 30 x 38 x 72 cm

# CONNECTING UNITS

Shelving inserts provide extra shelving space while taking up very little area. They are not free standing and so they need anchoring between two standard free-standing units. The sides make a perfect fit between the posts on both sides to create a stable construction.

**!** This is not freestanding unit



# CORNER UNITS

better space arrangement

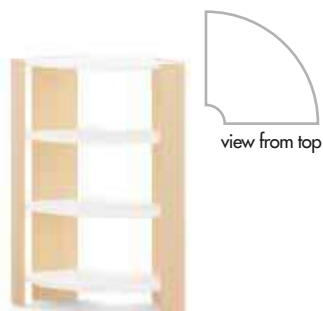

view from top

**Inside corner Crescent**  
**NS 1686**

• 56 x 56 x 102 cm

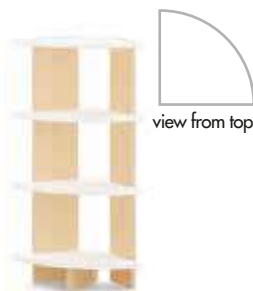

view from top

**Inside corner Quarter**  
**NS 1687**

• 40 x 40 x 102 cm

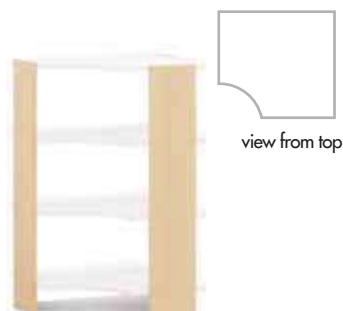

view from top

**Corner**  
**NS 1685**

• 66 x 66 x 102 cm







# maxi COLOR

Maxicolor. A series of functional birch laminate bookcases, cabinets and storage units. The bright-coloured fronts will enliven the room and help create a friendly and cheerful atmosphere. Runners with safety stops to prevent accidental falling out.

body birch  
laminated board

fronts  
laminated board



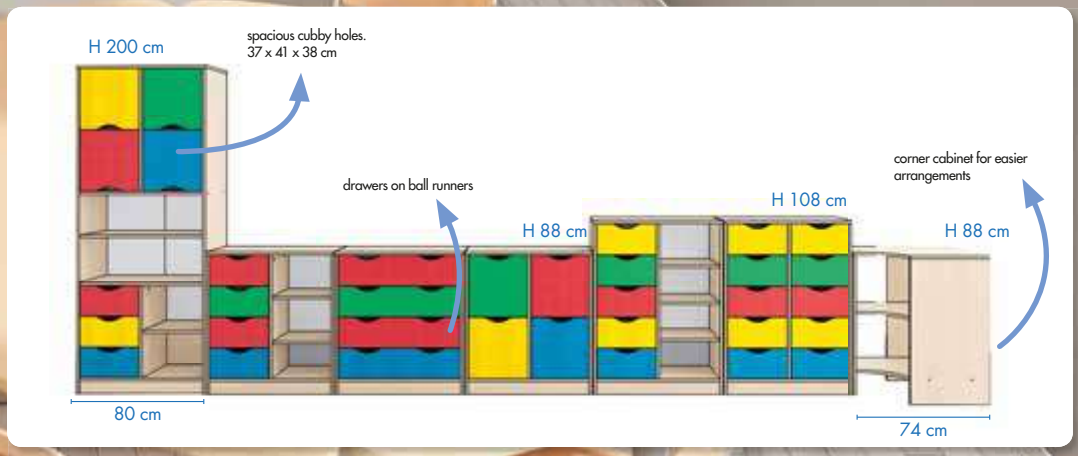

maxi  
color





**Tall storage unit**

**NS 0218**

• 80 x 47.5 x 200 cm



**Storage unit with shelves**

**NS 0216**

• 80 x 47.5 x 88 cm



**Storage unit with 4 drawers**

**NS 0214**

• 80 x 47.5 x 88 cm



**Medium storage unit**

**NS 2217**

• 80 x 47.5 x 108 cm



**Corner storage unit**

**NS 0238**

• 74 x 47.5 x 88 cm



**Storage unit with 4 doors**

**NS 0215**

• 80 x 47.5 x 88 cm



**Medium storage unit**

**NS 0217**

• 80 x 47.5 x 108 cm



# MODERN







# FURNITURE

OF MODERN SERIES

## TALL CABINETS

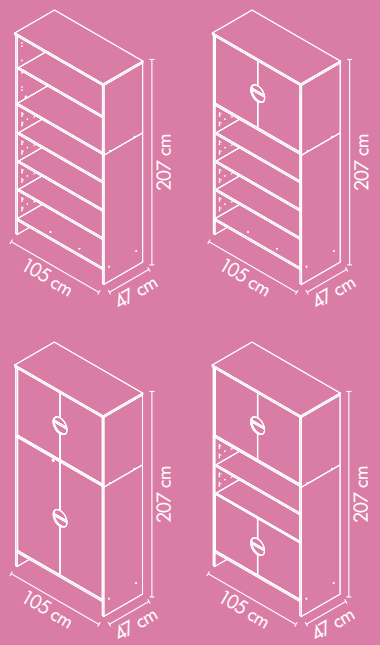

## ADD-ON

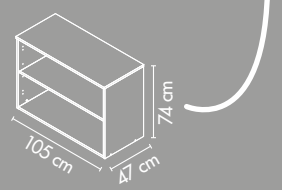

## CORNER

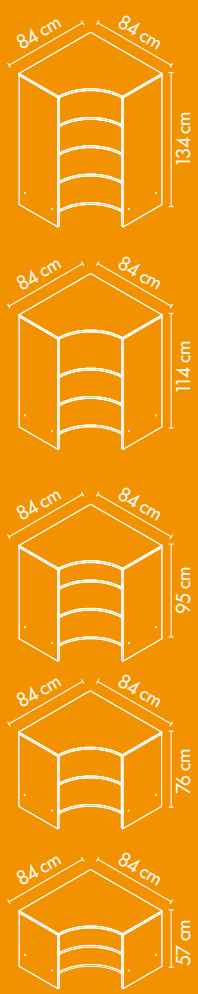

## SHELF

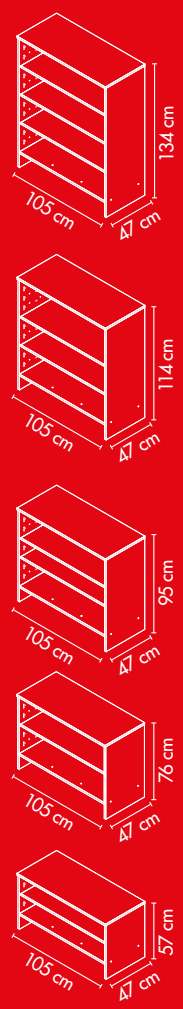

## TRAYS

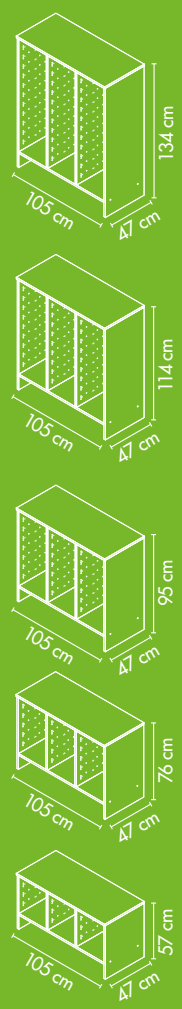

## COMPARTMENTS

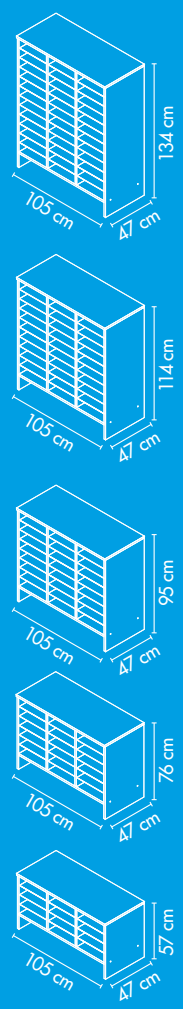



The Modern series combines functionality with modern design.

Particularly, the units can be adjusted to various rooms and different expectations from older and younger users. Five cabinet sizes, optional doors and top sections, a large display area, space for trays selected individually for size and colour - all these features make this set very practical and easy to use. The modern colour scheme will create bright atmosphere in every room.

- 5 heights of standard cabinets: 57 cm, 76 cm, 95 cm, 114 cm, 134 cm,
- 5 heights of cabinets with top extensions: 131 cm, 150 cm, 169 cm, 188 cm, 208 cm

Extras:

- plastic trays (deep and shallow)
- cardboard trays (deep and shallow)
- doors to cabinets and upper sections
- locks for selected models



body birch laminated board

trays orange cardboard and plastic

doors mdf



# FEATURES

each type available in 5 heights

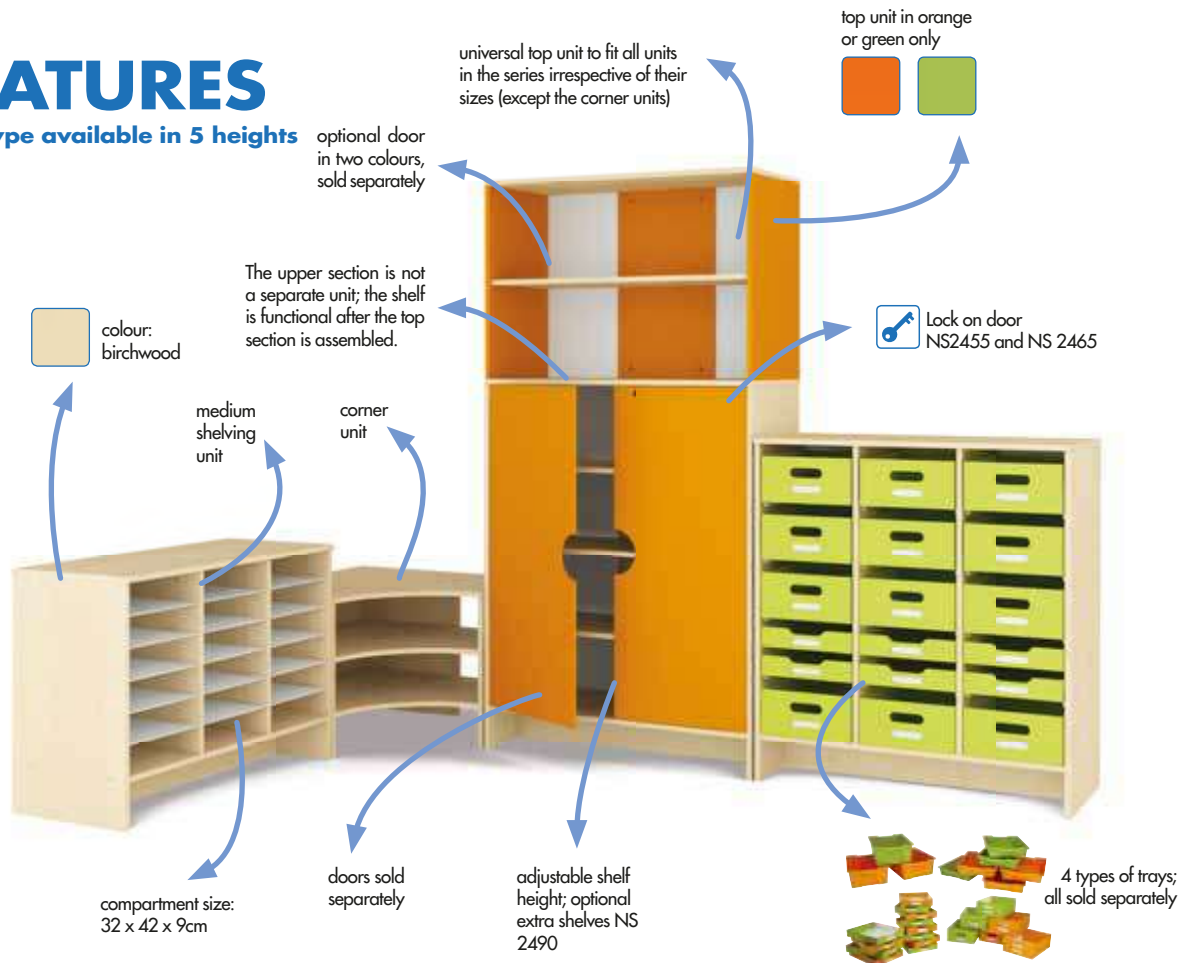

## UNITS WITH SHELVES

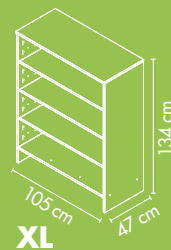
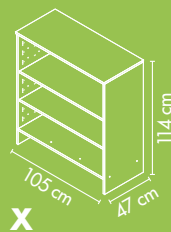
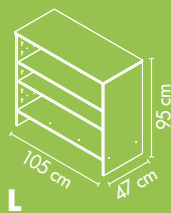
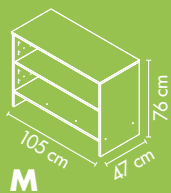
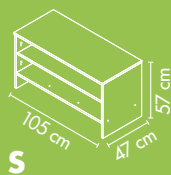

doors sold separately



**S**  
NS 2401



**M**  
NS 2402



**L**  
NS 2403



**X**  
NS 2404



**XL**  
NS 2405



## DOORS

sold in pairs



Doors NS 2455 and NS 2465 sold with a lock

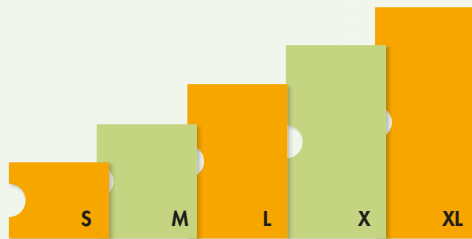

●	NS 2451	NS 2452	NS 2453	NS 2454	NS 2455	orange
●	NS 2461	NS 2462	NS 2463	NS 2464	NS 2465	green

## Add-on

Fits all medium shelf units. See page 116



units incompatible with doors



**S**  
NS 2411



**M**  
NS 2412



**L**  
NS 2413



compartment  
32 x 43 x 9 cm

**XL**  
NS 2414



**XL**  
NS 2415

## UNITS WITH COMPARTMENTS

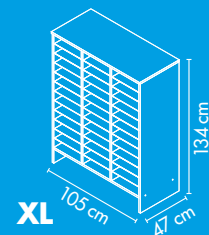

**XL**

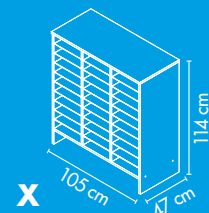

**X**

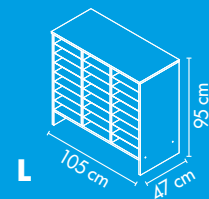

**L**

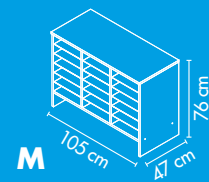

**M**

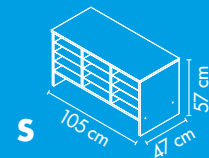

**S**





sold with runners

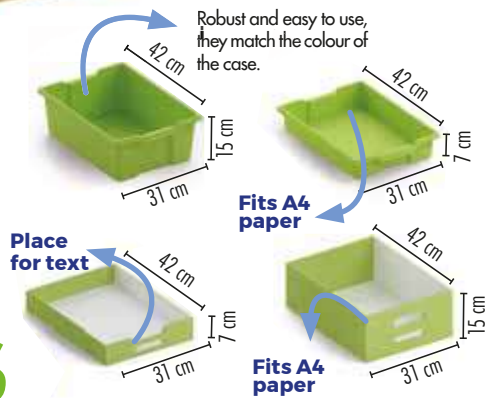

Trays	 Plastic	 Cardboard
3 pcs. Deep Orange	 NS 2300	
3 pcs. Deep Green	 NS 2301	
4 pcs. Deep Orange	 NS 2302	 NS 2478
4 pcs. Deep Green	 NS 2303	 NS 2479
6 pcs. Deep Orange	 NS 2306	 NS 2473
6 pcs. Deep Green	 NS 2307	 NS 2474
6 pcs. Shallow Orange	 NS 2304	
6 pcs. Shallow Green	 NS 2305	
8 pcs. Shallow Orange	 NS 2308	 NS 2476
8 pcs. Shallow Green	 NS 2309	 NS 2477
12 pcs. Shallow Orange		 NS 2471
12 pcs. Shallow Green		 NS 2472

sold with runners

# TRAYS

## UNITS FOR TRAYS

space for deep and shallow trays

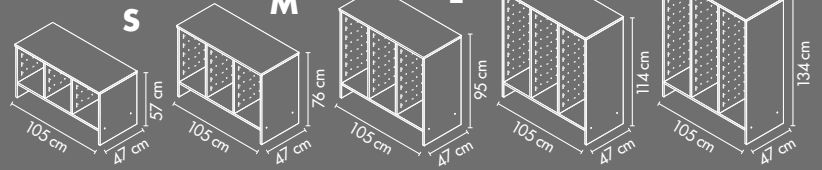

2 shallow trays take up the same space as 1 deep

trays sold separately



**S**  
NS 2421



**M**  
NS 2422



**L**  
NS 2423



**X**  
NS 2424



**XL**  
NS 2425

# ADD-ON

Fits all units in the series (except corner ones) to provide even more storage area

- not standalone
- available in 2 colours

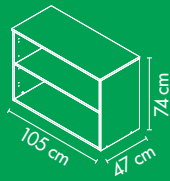

## HOW DOES



## IT WORK?



**!** NOT A STANDALONE UNIT functional only with a base unit underneath



- NS 2441 orange
- NS 2442 green

### Doors for add-on

- 49,5 x 69 cm
- sold in pairs



- NS 2456 orange
- NS 2466 green

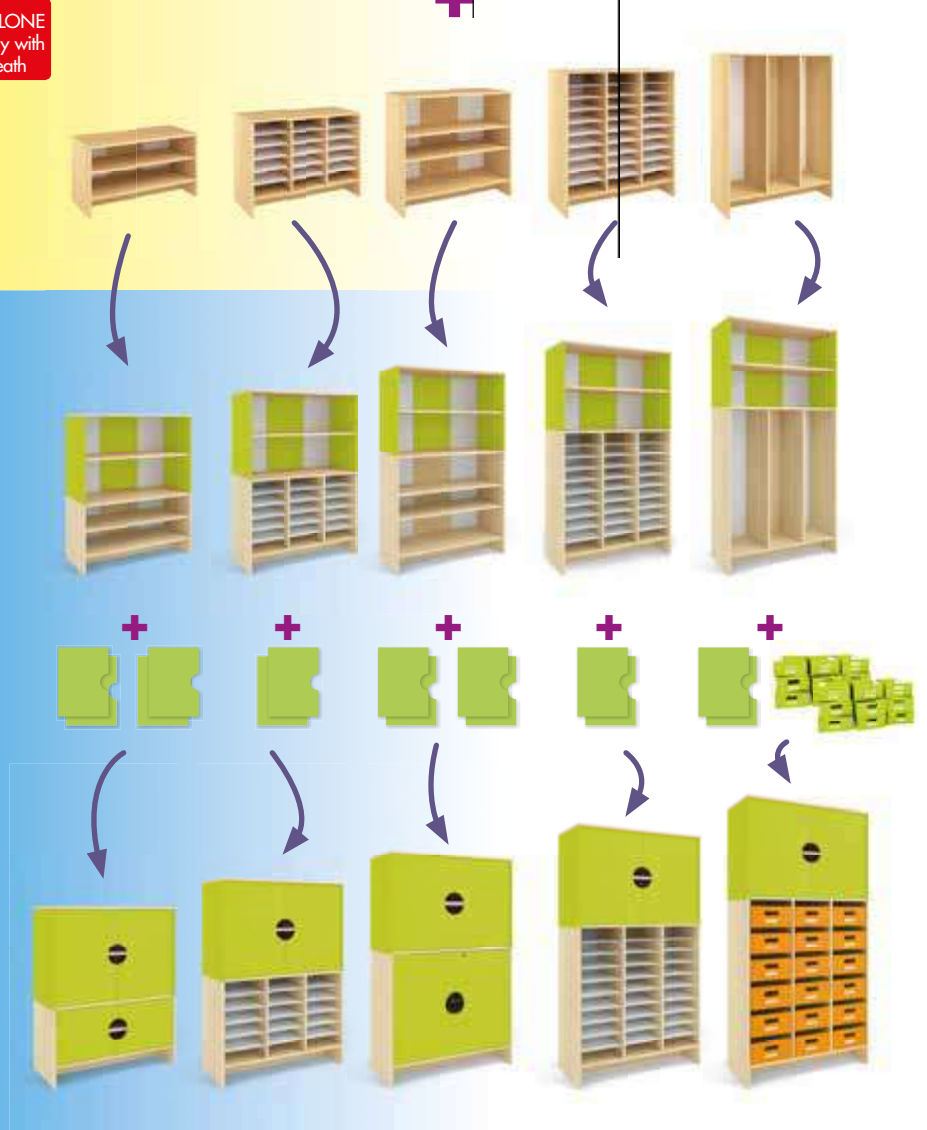

# TALL STORAGE

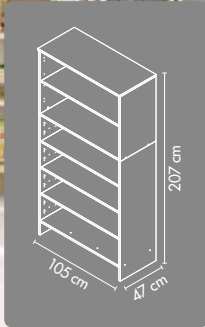

Shelving unit with door  
 ● NS 2433 orange  
 ● NS 2434 green



Shelving unit with 2 doors  
 ● NS 2437 orange  
 ● NS 2438 green



Shelving unit  
 ● NS 2431 orange  
 ● NS 2432 green



Shelving unit with 2 doors  
 ● NS 2435 orange  
 ● NS 2436 green



# CORNER UNIT



**S**  
 NS 2481



**M**  
 NS 2482



**L**  
 NS 2483



**X**  
 NS 2484



**XL**  
 NS 2485

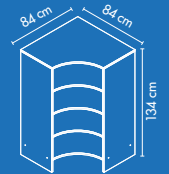
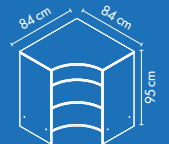
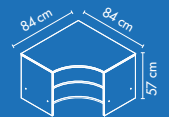
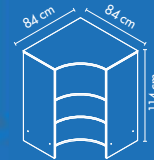
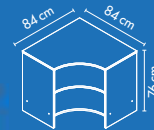



**Science Cart**  
**NM 4033**

Experiments require accessories. This unit will hold them all in trays. Transportation is easy - just grab the handles and move the cart to its destination.

- dimensions: 68,5 x 45 x 88 cm
- will hold 6 large or 12 small trays (sold separately); castors with brakes



**Treasure Island**  
**NS 2409**

- basic module for configurations; birch finish
- 4 castors with brakes

**Maxi treasure island**  
**NS2410**

- basis for configurations
- 124 x 83 x 53 cm (with castors)
- top 76 x 117 cm
- 5 lockable castors



**City road rollover**  
**HK 0007**

- 75 x 75 cm
- antislip bottom



**Maxi city road rollover**  
**HK 0014**

- fits Maxi Treasure Island (NS 2410)
- 75 x 115 cm.
- antislip bottom

**Doors**

- pair of doors 39 x 36 cm
- pair of shelves 32 x 41 cm
- hinges 270°



- NS 2487 orange
- NS 2488 green





# TREASURE ISLAND

large play area - top 76 x 76 cm  
(optional mat HK 0007)



basic module  
always in birch

4 types of trays;  
alternatively shelves

doors in 3 colours; wide  
angle hinges (270°)

Module sold with castors.  
Other accessories sold  
separately

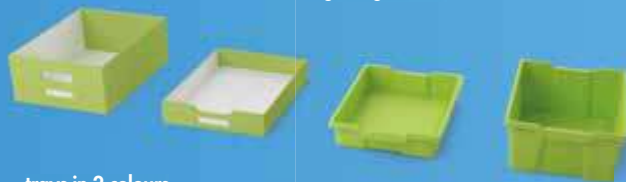

## trays in 2 colours

The four compartments will hold any plastic or cardboard trays. With 2 small ones taking up as much space as 1 large, various configurations of both types are possible.

Trays available on page 114



all elements sold separately

The basic module can be equipped with accessories (sold separately). The bays can hold shelves or trays. Optional doors (in 2 colours) can be mounted on wide-angle hinges. Another useful accessory is a city road play mat (on which to construct houses and drive toy cars)

- 83 x 83 x 53 cm (with castors); top 76 x 76 cm
- 4 castors with brakes





door option available

the same height of all cabinets: 190 cm

silicon bumper in all modules v

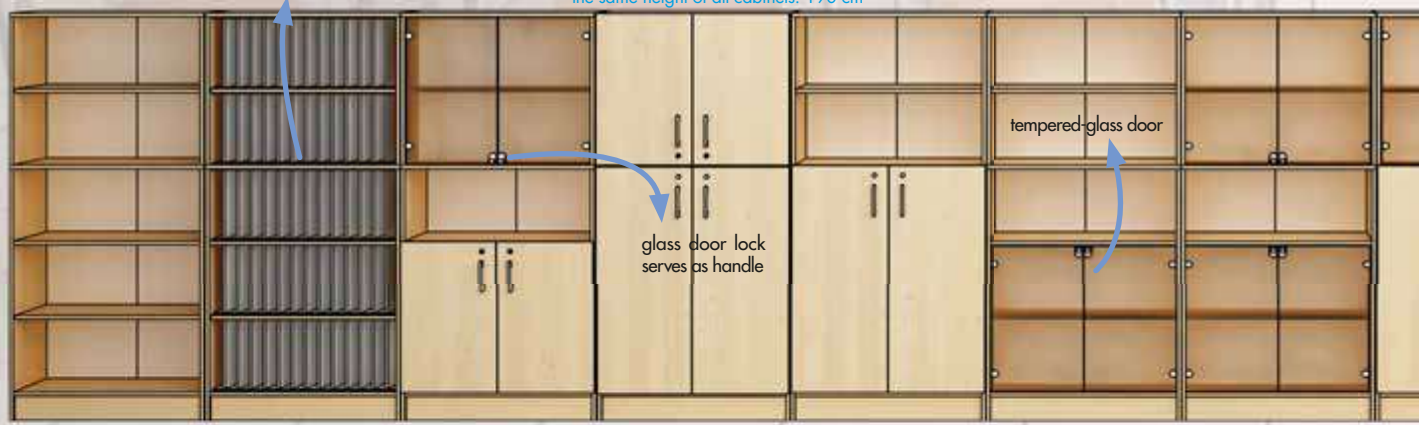

# PRIMA

The central theme of the economy series Prima are muted colours and a wealth of combinations. Its formal minimalism and functionality make it a universal set of furniture, ideal for a classroom, biology room, teachers' room or the head's office.

The spacious cubby holes will accommodate educational aids, ring binders, books and class registers. The open shelves are intended for the handiest objects and documents. The lockable units will be useful for important documents or aids with restricted access.

- one color of the frame: birch or beech
- the same dimensions for all units
- two door versions: laminated board and glass - both lockable
- ready-made sets available as seen
- cabinet for registers
- dimensions: 90 x 40 x 190 cm

with glass doors

all doors with locks



body and fronts  
laminated board

birch

beech

# PRIMA FEATURES

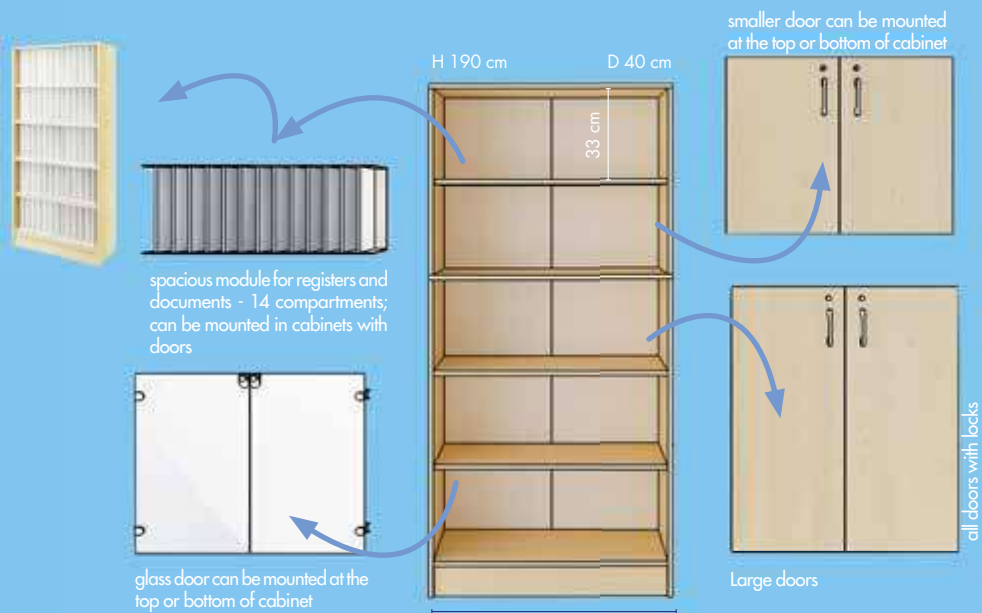



birch



beech



birch NB 2001  
beech NB 2002



birch NB 2011  
beech NB 2012



birch NB 2021  
beech NB 2022



birch NB 2211  
beech NB 2212



birch NB 2221  
beech NB 2222



birch NB 2111  
beech NB 2112



birch NB 2131  
beech NB 2132



birch NB 2231  
beech NB 2232



birch NB 2031  
beech NB 2032



**Prima desk right**

**birch** NB 6201

**beech** NB 6202

• 155 x 110 x 75 cm



**Prima desk left**

**birch** NB 6101

**beech** NB 6102

• 155 x 110 x 75 cm



**Conference table**

**birch** NB 5001

**beech** NB 5002

• 70 x 180 x 73 cm



**Small Wardrobe**

**birch** NB 4041

**beech** NB 4042

• 46 x 40 x 190



PRIMA



**Large Wardrobe**

**birch** NB 3041

**beech** NB 3042

• 90 x 40 x 190



birch

beech

# SCIENCE CLASSROOM



# TEACHER'S ROOM

# FRESH

Our furniture series Fresh allows for optimum adaptation of a room, while giving it lightness. This is possible thanks to the variety of wall cabinet and shelving types and all the cupboards are available in two sizes. Additionally, the legs and castors create an extra space which makes the room look larger, as well as providing easy access underneath for cleaning.

The shelf units are available in several types and all the medium standing units in two width sizes.

The distinctive feature of the line are the colourful shelves; the distances between them allow for easy storage of documents and ring binders.

The new version of Fresh furniture line helps arrange the classroom so as to display educational aids in a better way. Children may watch models and figures through the glass doors of cabinets to which, however, only the teacher has the keys.

This line is particularly recommended for biology classrooms, in which observation and experimentation are the most commonly used teaching methods.

- three colour options: orange, green and birch;
- two sizes of standing and hanging cabinets (92 and 47 cm).
- coloured shelves
- handy handles (the colour matches that of the doors, drawers and shelves)
- easy assembly
- sold with legs
- plastic legs (orange, green or brown; 4 pieces, H 10 cm)
- accessories sold separately







# MODULES

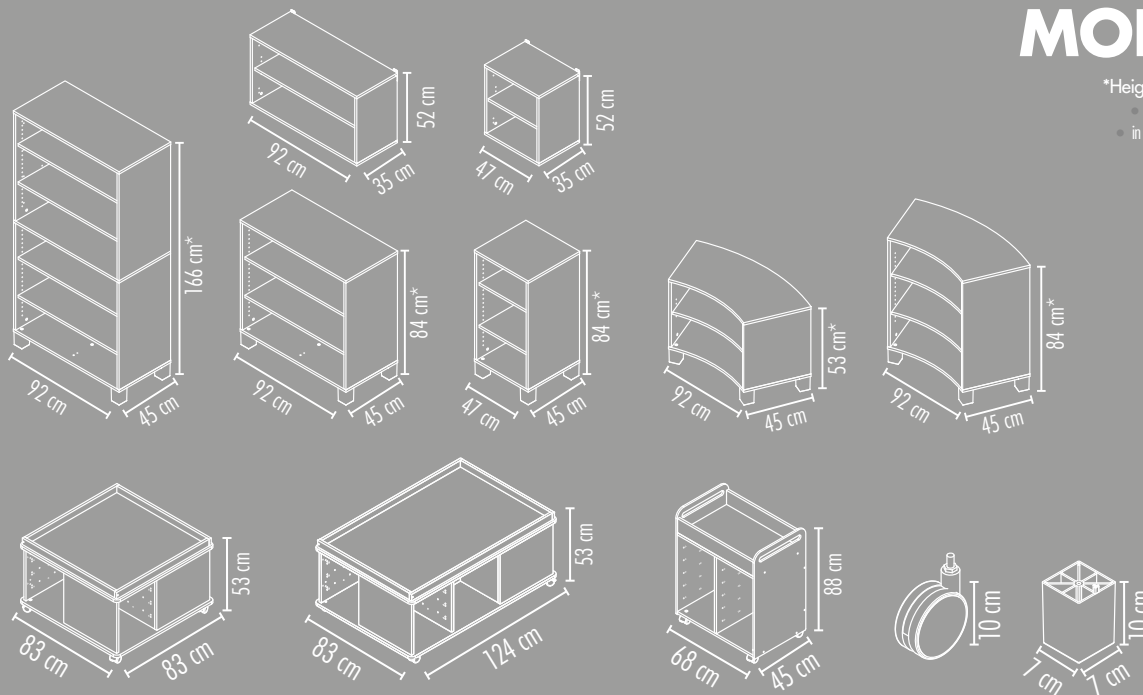

\*Height without legs or castors.

- in case of legs you should add 10 cm
- in case of castors you should add 10 cm

## COLOURS



### DOORS AND SHELVES

ORANGE

GREEN

BIRCH

GLASS\*

\*applies only for doors

### BODY

BIRCH

### LEGS AND HANDLES

ORANGE

GREEN

BEIGE

## FEATURES



lockable doors available



leg sets in 3 colours



castor set with and without a locking brake, sold separately



furniture for self-assembly



adjustable shelf height



# FEATURES



laminate body  
in birch finish



lockable glass  
door

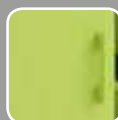

doors in three colours with  
or without a lock



adjustable shelf  
height



tempered glass  
door



For cabinets from page 68 modules in orange or green are supplied with plastic trays in the same colours. Modules in birch colour are always supplied with trays in orange.

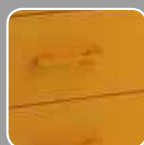
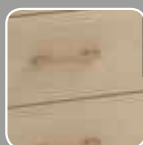

fronts and handles in 3 colours: beige,  
orange and green. Drawers with roller  
runners with a slide end lock



leg sets (in 3 colours) and lockable castors  
(sold separately)



Cardboard and  
plastic trays are  
available in orange  
and green.

# TALL CABINETS

92 x 45 x 176 cm (height with legs)



Tall cabinets are a good storage place for educational aids or documents. All things that you want to keep safe yet handy should go into cabinets and drawers. Books are most handy on open shelves and aids will look their best behind glass lockable doors.

With height-adjustable shelves you can make the most of the cabinet space.

Things intended to be accessible to all are best placed on open shelves. Those used under the supervision of a teacher should be locked behind a glass door.



All cabinets sold with legs

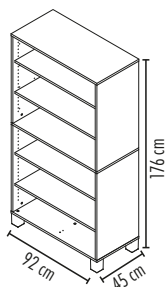

height-adjustable shelves



with shelves

● NM 3001	orange
● NM 3002	green
● NM 3003	birch

shelves always the same colour as the doors and drawers



with shelves & double glass doors

● NM 3331	orange
● NM 3332	green
● NM 3333	birch



with doors & shelves

● NM 3011	orange
● NM 3012	green
● NM 3013	birch



with shelves & glass doors

● NM 3301	orange
● NM 3302	green
● NM 3303	birch



with drawers  
& glass doors

- NM 3321 orange

---

- NM 3322 green

---

- NM 3323 birch



with shelves,  
doors & glass doors

- NM 3311 orange

---

- NM 3312 green

---

- NM 3313 birch

Version with lockable doors

- NM 3341 orange

---

- NM 3342 green

---

- NM 3343 birch



with doors & shelves

- NM 3111 orange

---

- NM 3112 green

---

- NM 3113 birch

Version with lockable doors

- NM 3441 orange

---

- NM 3442 green

---

- NM 3443 birch



with drawers,  
doors & shelves

- NM 3121 orange

---

- NM 3122 green

---

- NM 3123 birch

Version with lockable doors

- NM 3421 orange

---

- NM 3422 green

---

- NM 3423 birch



with drawers & shelves

- NM 3021 orange

---

- NM 3022 green

---

- NM 3023 birch

# FRESH



with trays, doors & shelves

- NM 2081P orange
- NM 2082P green
- NM 2083P birch



with trays, doors & shelves

- NM 2081B orange
- NM 2082B green
- NM 2083B birch

birch cabinets always with orange trays



with trays & shelves

- NM 2061P orange
- NM 2062P green
- NM 2063P birch



with trays, doors & shelves

- NM 2061B orange
- NM 2062B green
- NM 2063B birch

## CABINETS CABINETS WITH PLASTIC TRAYS

### MEDIUM CABINETS

92 x 45 x 94 cm (height with legs)



Available in units with deep or shallow trays, with or without doors. Shelves always the same colour as the doors and drawers.

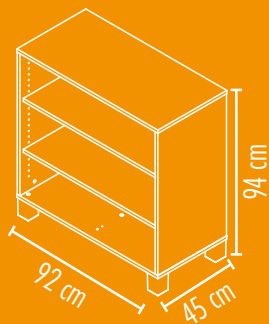

with shelves

- NM 2001 orange
- NM 2002 green
- NM 2003 birch



with shelves

- NM 2051 orange
- NM 2052 green
- NM 2053 birch

### CUBBY HOLE UNITS



with shelves

- NM 2061 orange
- NM 2062 green
- NM 2063 birch



with doors & shelves

- NM 2081 orange
- NM 2082 green
- NM 2083 birch

space for 4 deep or 8 shallow trays

different types and colours



2 shallow trays take up the same space as 1 deep. The cabinets can hold various combinations trays.





with drawers

- **NM 2021 orange**
- **NM 2022 green**
- **NM 2023 birch**



with doors & shelves

- **NM 2011 orange**
- **NM 2012 green**
- **NM 2013 birch**



with doors & shelves

- **NM 2041 orange**
- **NM 2042 green**
- **NM 2043 birch**



In all medium cabinets castors can be mounted.

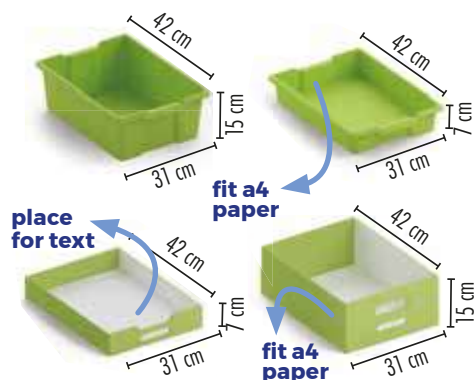
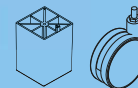

runners in set

## TRAYS



Trays



Plastic



Cardboard

3 pcs. Deep Orange		NS 2300	
3 pcs. Deep Green		NS 2301	
4 pcs. Deep Orange		NS 2302	NS 2478
4 pcs. Deep Green		NS 2303	NS 2479
6 pcs. Deep Orange		NS 2306	NS 2473
6 pcs. Deep Green		NS 2307	NS 2474

Trays



Plastic



Cardboard

6 pcs. Shallow Orange		NS 2304	
6 pcs. Shallow Green		NS 2305	
8 pcs. Shallow Orange		NS 2308	NS 2476
8 pcs. Shallow Green		NS 2309	NS 2477
12 pcs. Shallow Orange			NS 2471
12 pcs. Shallow Green			NS 2472

# SMALL CABINETS

92 x 45 x 94 cm (height with legs)



Small cabinets take up only 0.5 m<sup>2</sup> of floor area but they can hold a great deal. They come with drawers or shelves, with or without doors.

The shelves are always the same colour as the doors and drawers in the set.

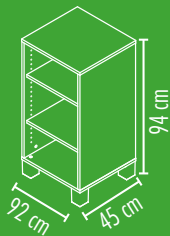

In all small cabinets legs or castors (sold separately) can be installed



with door & shelves

- NM 1011 orange
- NM 1012 green
- NM 1013 birch

with drawers

- NM 1021 orange
- NM 1022 green
- NM 1023 birch

with shelves

- NM 1001 orange
- NM 1002 green
- NM 1003 birch







with shelf

- NM 5001 orange
- NM 5002 green
- NM 5003 birch

with shelf

- NM 6001 orange
- NM 6002 green
- NM 6003 birch

with door & shelf

- NM 5011 orange
- NM 5012 green
- NM 5013 birch

with doors & shelves

- NM 6011 orange
- NM 6012 green
- NM 6013 birch

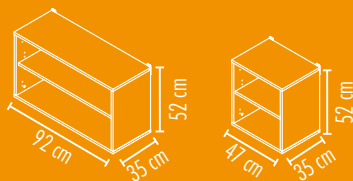

**WALL  
SHELVES**



The set consists of: Foam 1, Foam 2,  
NM 7072 x6, NM 7002 x2



## FITS EVERY SPACE



The set consists of: Foam 1, Foam 2,  
NM 7072 x3, NM 7002



The set consists of: Foam 2 x2, NM  
7072 x2, NM 70022 x6 + castors

The set consists of: Foam 1 x2, NM  
7072 x6, NM 7002 x2

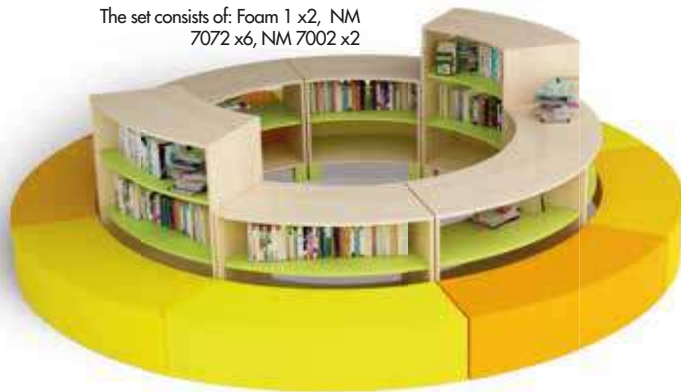

# CORNER UNITS



accessible from each side  
height-adjustable shelves

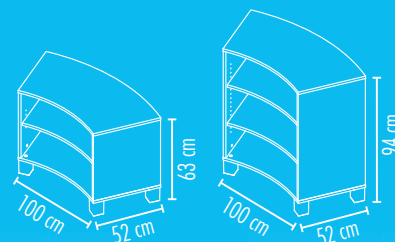

## Wheels

### NJ 0904

- 4 pcs., 2 with brakes
- H 10 cm



With these open-frame bookcases accessible from each side you will maximize the available floor space. Units can be combined into gently curved forms, thus adding a modern and creative flavour to the room. Available in two sizes and three colour versions of shelves.

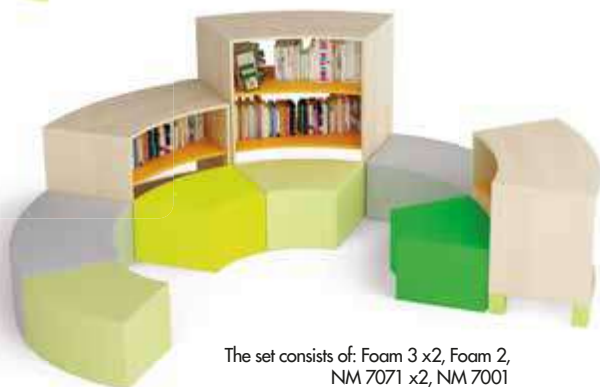

The set consists of: Foam 3 x2, Foam 2, NM 7071 x2, NM 7001



## Big

- NM 7001 orange
- NM 7002 green
- NM 7003 birch

## Small

- NM 7071 orange
- NM 7072 green
- NM 7073 birch

The set consists of: Foam 3, NM 7073 x2, NM 7003



## FOAM SHAPES FOR CURVED UNITS

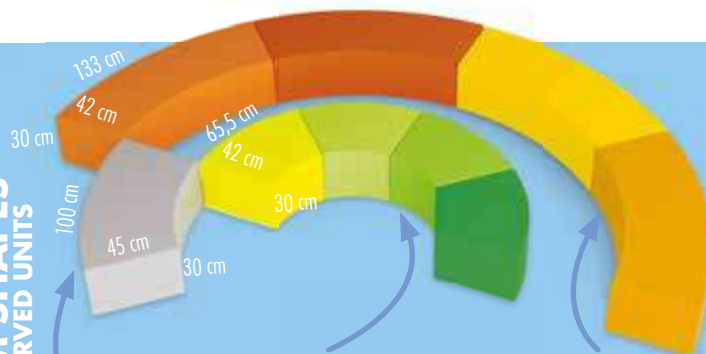

### Foam 3 Grey NS 2181

- 1 pc. 100 x 30 x 45 cm,

### Foam 2 Green NS 2179

- 4 pcs., 65,5 x 30 x 45 cm
- total length: 300 cm

### Foam 1 Sunny NS 2180

- 4 pcs., 133 x 30 x 45 cm,
- total length: 528 cm

# SHELVES

sold in 2 pcs.



### Big shelves

• 88 x 42 cm, 2 pcs.

- NM 2201 orange
- NM 2202 green
- NM 2203 birch



### Small shelves

• 43 x 42 cm, 2 pcs.

- NM 1201 orange
- NM 1202 green
- NM 1203 birch

### height-adjustable shelves



## TRAYS

runners included



## castors and legs



### Wheels

#### NJ 0904

- 4 pcs., 2 z brake
- H 10 cm



### Legs

• 7 x 7 x 10 cm, 4 pcs.

- NJ 0901 orange
- NJ 0902 green
- NJ 0903 beige



### Trays

	Plastic	Cardboard
3 pcs. Deep Orange	NS 2300	
3 pcs. Deep Green	NS 2301	
4 pcs. Deep Orange	NS 2302	NS 2478
4 pcs. Deep Green	NS 2303	NS 2479
6 pcs. Deep Orange	NS 2306	NS 2473
6 pcs. Deep Green	NS 2307	NS 2474
6 pcs. Shallow Orange	NS 2304	
6 pcs. Shallow Green	NS 2305	
8 pcs. Shallow Orange	NS 2308	NS 2476
8 pcs. Shallow Green	NS 2309	NS 2477
12 pcs. Shallow Orange		NS 2471
12 pcs. Shallow Green		NS 2472

### Glass doors

#### NM 0030

- 80 x 44 cm
- with lock
- 2 pcs.
- silicone bumpers



### Deep

• 42 x 31 x 15 cm

## plastic



### Deep

• 42 x 31 x 15 cm

### Shallow

• 42 x 31 x 7 cm



### Shallow

• 42 x 31 x 7 cm

## cardboard

# TREASURE ISLAND

**all elements sold separately**

The basic module can be equipped with accessories (sold separately). The bays can hold shelves or trays. Optional doors (in 2 colours) can be mounted on wide-angle hinges. Another useful accessory is a city road play mat (on which to construct houses and drive toy cars)

- 83 x 83 x 53 cm (with castors); top 76 x 76 cm
- 4 castors with brakes

large play area  
- top 76 x 76 cm  
(optional mat HK 0007)



place for text

4 types of trays;  
alternatively shelves

basic module  
always in birch

doors in 3 colours; wide  
angle hinges (270°)

4 castors with lock



## Treasure Island

**NS 2409**

- basic module for configurations; birch finish
- 4 castors with brakes



## Maxi treasure island

**NS2410**

- basis for configurations
- 124 x 83 x 53 cm (with castors)
- top 76 x 117 cm
- 5 lockable castors

### Doors

- pair of doors 39 x 36 cm
- pair of shelves 32 x 41 cm
- hinges 270°



- NS 2487 orange
- NS 2488 green



### trays in 2 colours

The four compartments will hold any plastic or cardboard trays. With 2 small ones taking up as much space as 1 large, various configurations of both types are possible.

### Maxi city road rollover

**HK 0014**

fits Maxi Treasureless  
Island (NS 2410)

- 75 x 115 cm
- antislip bottom



### City road rollover

**HK 0007**

- 75 x 75 cm
- antislip bottom
- for NS 2409

# LIBRARIES

## BOOK STORAGE



**Single module; doublesided**  
**NL 0491**

- 87 x 49 x 189 cm
- 12 shelves H 31 cm



**Fresh**  
**NM 3003**

- 92 x 45 x 176 cm
- birch



**Prima birch**  
**NB 2001**

- 90 x 40 x 190 cm
- birch



**Prima beech**  
**NB 2002**

- 90 x 40 x 190 cm
- beech



**Seria+**  
**NS 1684**

- 90 x 40 x 192 cm
- beech



**Classical**  
**NW 0718**

- 84 x 40 x 200 cm
- beech

# CORNER UNITS



The set consists of: Foam 1, Foam 2, NM 7072 x6, NM 7002 x2



The set consists of: Foam 3 x2, Foam 2, NM 7071 x2, NM 7001 + legs



Big | 100 x 52 x 94 cm

- NM 7001 orange
- NM 7002 green
- NM 7003 birch



Small | 100 x 52 x 63

- NM 7071 orange
- NM 7072 green
- NM 7073 birch



The set consists of: Foam 3, NM 7073 x2, NM 7003 + legs

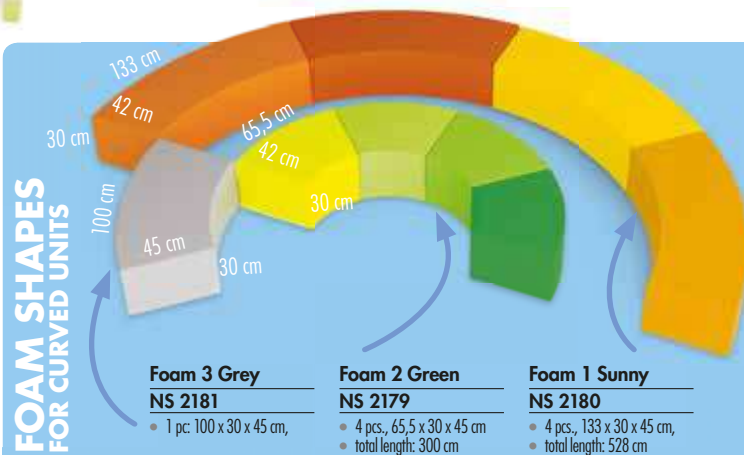

## BEECH BOOK DISPLAYS



doublesided:  
3 display tiers on one side  
3 shelves on the other

### Small double-sided NS 0877

• 90 x 40 x 102 cm

doublesided:  
4 display tiers on one side  
4 shelves on the other

### Tall double-sided NS 0878

• 90 x 40 x 115 cm

wall-mounted

### Wall mounted NS 1721

• 94 x 20 x 130 cm

## BIRCH BOOK DISPLAYS



double-sided

### Double sided NS 1481

- 102 x 45 x 125 cm
- miejsce na ekspozycję oraz składowanie książek

storage cart with compartments; supplement for NS 1481 or NS 0279

### Mobile container NS 1482

• 95 x 42 x 30 cm

compartments with movable dividers

### Book container NS 0279

• 102 x 42 x 70 cm

wall-mounted or free-standing  
4 tiers of shelves

### Wall mounted NS 1483

• 92 x 16 x 124 cm

### Double sided & mobile container set NS 1484

- NS 1482 – 95 x 42 x 30 cm;
- NS 1481 – 102 x 45 x 125 cm

### Book & Mobile containers set NS 1485

- NS 1482 – 95 x 42 x 30 cm;
- NS 0279 – 102 x 42 x 70 cm



## Book container

3 colours 74 x 34 x 69 cm

This child-friendly furniture will be an ideal central point of the reading corner but it can easily make a handy storage space for games, building blocks and other toys. It is easily accessible from each side and the comfortable pouffes add to its functionality. It will be useful both in nurseries and daycares.



**Beech**  
NS 1706



**Birch**  
NS 1707



**White**  
NS 1708



**Poufs for container**  
NS 1709

- 2pcs, 35 x 35 x 30 cm



## Library Unit

NS 1741

Double-sided unit with compartments for books, two pouffs and two containers on casters. Laminated chipboard. Colour: birchwood. Safe rounded edges.

- book container,
- 2 containers on wheels,
- 2 pouffs



**Book container with pouffs**  
NS 1742

- container: 50 x 92 x 64 cm
- pouffs: 44 x 45 x 28 cm



**Book container**  
NS 1743

A bookcase unit with 4 compartments and space for two boxes underneath

- 50 x 92 x 64 cm



**Containers on wheels**  
NS 1744

- 2 pcs., 44 x 45 x 28 cm



**Rounded pouffs**  
NS 1745

- 2 pcs., 30 x 92 x 30 cm

These free-standing bookcases are great for holding books, toys or boardgames in school libraries or nursery thematic corners. They have been intended to accompany the furniture series FRESH. The sides are made of laminated particleboard with birch effect and have slanting or traditional right-angle shelves depending on the model. The cubby holes provided will help to keep the place tidy. If necessary, legs or castors (sold separately) can be attached.





# FRESH BOOK DISPLAYS



**Wheels**  
NJ 0904

- 4 pcs., 2 with brakes
- H 10 cm



**Legs**

- 4 pcs., 7 x 7 x 10 cm



- NJ 0901 orange
- NJ 0902 green
- NJ 0903 birch



**Container**  
NM 9120

- 86 x 45 x 33 cm

**Book Display**  
NM 9110

- 92 x 45 x 116 cm



**Book Display**

- 92 x 45 x 116 cm

- NM 9331 orange
- NM 9332 green



**Double sided book display**

- 92 x 45 x 116 cm

- NM 9321 orange
- NM 9322 green



**Wall book display**

- 92 x 17 x 105 cm

- NM 9311 orange
- NM 9312 green



**Bookcase**  
NS 9500

- 45 x 45 x 49 cm

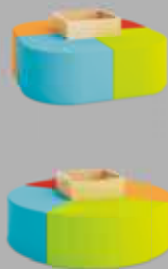

**Bookcase**

- 92 x 45 x 94 cm

- NM 9201 orange
- NM 9202 green

foam mat



**Bookcase**

- 92 x 45 x 38 cm

- NM 9401 orange
- NM 9402 green



castors sold separately



In all bookcases castors can be mounted.

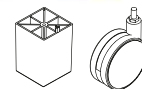

# FRESH SNAKE

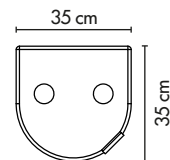
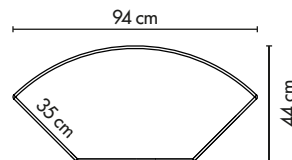
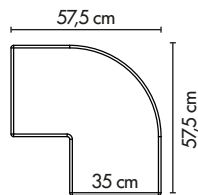

35 cm height of all elements



## Pouf – Oval

### NM 0015

- 2 pieces 58 x 58 x 35cm in blue and green,
- 2 pieces 67 x 67 x 35 cm in orange and green



## Pouf - Cube

### NM 0010

- 4 pieces 58 x 58 x 35cm in orange, blue, green and red



## Foam seats – Snake

### NM 0100

An element intended to enrich the bookcase series Fresh. The coloured poufs will make great seats for children to relax while listening to a story or reading a favourite book. The set of nine soft poufs can be used as a decoration in each room. The elements can also be joined together as puzzle pieces and so inspire children to play creatively in a playgroup or at school. All the elements are ergonomic and easy for children to carry around and arrange as they please, and they are safe thanks to no sharp edging. The cover is nice to the touch and easy to clean.

- 4 shapes 58 x 58 x 35 cm in orange, blue, green and red.
- 4 shapes 67 x 67 x 35 cm in blue, green and red.
- snake's head 35 x 35 x 35 cm in yellow.
- particular elements can form a pouf around a box to match the bookcase Fresh (NM9500). It is possible to buy only four elements with which to form a cube (NM0010), a circle (NM0020) or an oval (NM 0015).

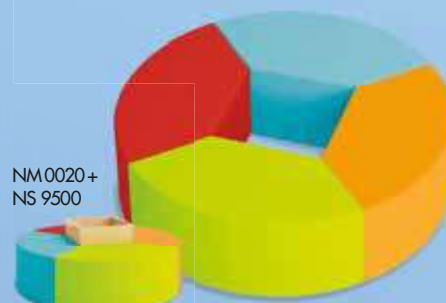

NM 0020 +  
NS 9500

## Pouf – Circle

### NM 0020

- 4 pieces 67 x 67 x 35 cm in orange, blue, green and red



## Pouf – Snake's Head

### NM 0001

- 1 piece 35cm x 35cm x 35 cm in yellow;

## FREESTANDING UNITS

The units have a sturdy metal frame. The shelves are made of laminated chipboard and have stops to protect books from sliding down.

Versions available: single-module double-sided (NL 0491), triple-module double-sided (NL 0493), double-sided extensions (NL 0492). Intended for schools and other educational institutions.

- 254 x 49 x 189 cm; 36 shelves



**3 modules; double-sided**  
**NL 0493**

- 254 x 49 x 189 cm
- 36 shelves H 31 cm

**Single module; double-sided**  
**NL 0491**

- 87 x 49 x 189 cm
- 12 shelves H 31 cm

**Double-sided add-on**  
**NL 0492**

- 85 x 49 x 189 cm
- 12 shelves H 31 cm

## BOOKCASES

## WALL UNITS

The units have a sturdy metal frame. The shelves are made of laminated chipboard and have stops to protect books from sliding down.

Versions available: single-module double-sided (NL 0341), triple-module double-sided (NL 0343), double-sided extensions (NL 0342). Intended for schools and other educational institutions.

- 85 x 34 x 189 cm; 36 shelves



**3 modules**  
**NL 0343**

- 254 x 34 x 189 cm
- 18 shelves H 31 cm

**Single module**  
**NL 0341**

- 87 x 34 x 189 cm
- 6 shelves H 31 cm

**Add-on**  
**NL 0342**

- 85 x 34 x 189 cm
- 6 shelves H 31 cm

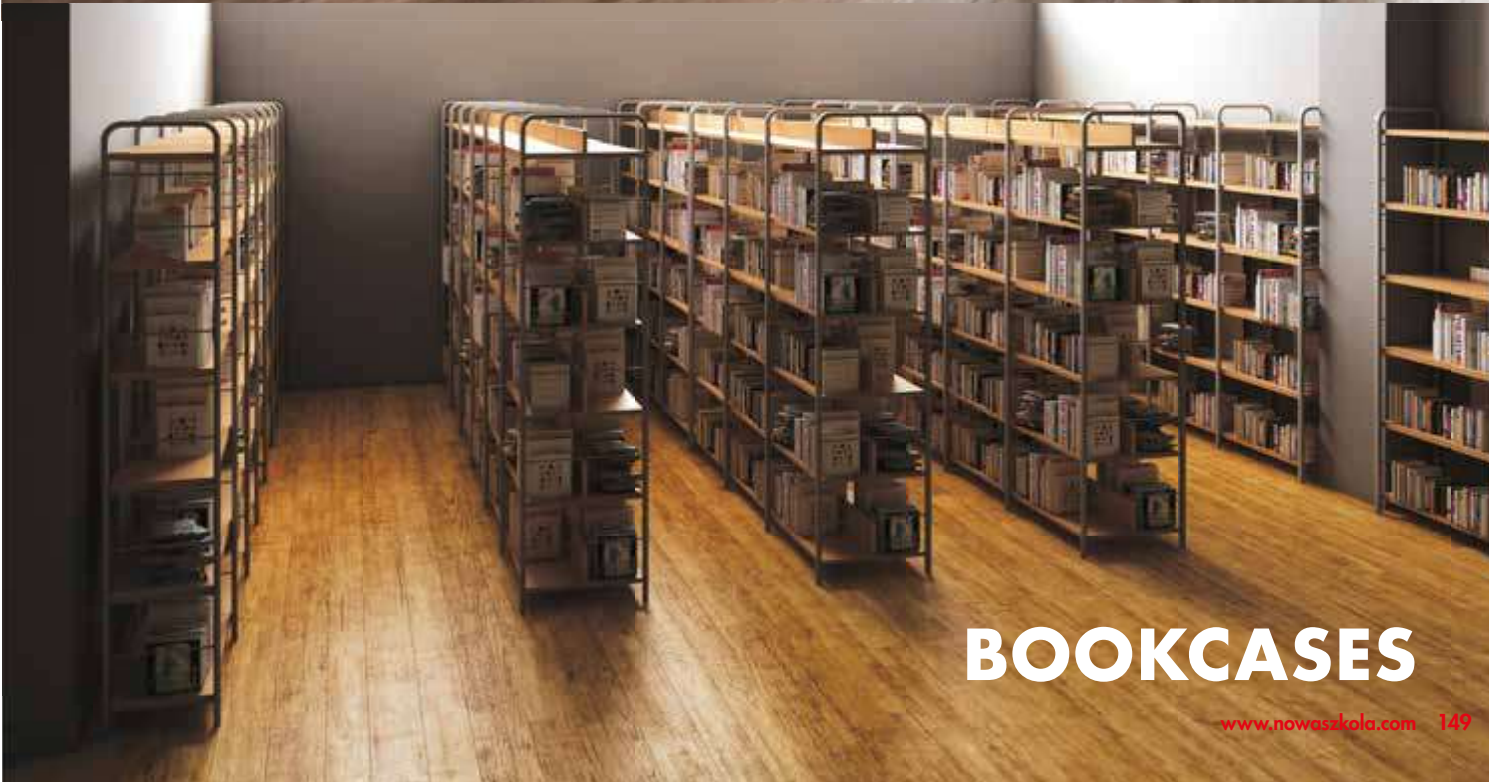

# BOOKCASES



**Grey**  
NS 1719



**Green**  
NS 1705



**Turquoise**  
NS 2719

**Bookcase Letter**

for storing books, games, toys;  
ideal for theme corners. Sides  
made of laminate; 5 deep  
pockets

- 72 cm x 34 cm x 92 cm

5 deep pockets  
heavy-duty polyester  
fabric

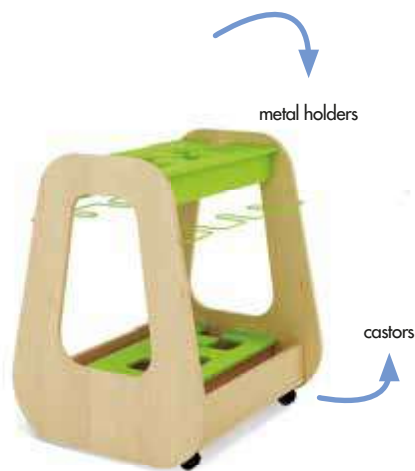
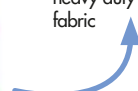

**Wheeled multipurpose rack**  
NS 1697

multifunctional storage unit for maps, charts,  
paper rolls

- 72 x 65 x 84 cm
- 4 wheels





# SHELVES

Free-standing display units with easy access to shelves and with fairytale design. The shelves can hold games, aids, toys, or children's artwork.

## Castle – manipulative walls NS 1717

A tower-shaped activity corner with 4 different panels on 4 walls: a flower with a safe mirror, a puzzle piece with a square maze, a puzzle piece with a triangular maze, a double-handed maze Snails.

- 72 x 72 x 134 cm



## Bear Interactive Kiosk NS 1716

Multimedia kiosk is a bear-shaped stand for a tablet intended specially for children. The furniture will perfectly fill the space in play corners and provide educational entertainment for the youngest. The kiosk, equipped with an easy-to-use tablet, has been very carefully designed. The white framework is made of laminated particleboard, with the bear-shaped front made of MDF board.

- 90 x 40 x 130 cm.





**Owl**  
**NS 0907**

• 116 x 40 x 120 cm

W 116 cm  
D 40 cm  
H 120 cm



**Wizard**  
**NS 2895**

• 92 x 36 x 120 cm

W 92 cm  
D 36 cm  
H 120 cm



**Apple**  
**NS 0433**

• 116 x 55 x 118 cm

W 116 cm  
D 55 cm  
H 118 cm



**Frog**  
**NS 0906**

• 108 x 47 x 120 cm

W 108 cm  
D 47 cm  
H 120 cm



**Dragon**  
**NS 2896**

• 116 x 36 x 92 cm

W 116 cm  
D 36 cm  
H 92 cm



**Sun**  
**NS 0473**

• 180 x 61 x 140 cm

W 180 cm  
D 61 cm  
H 140 cm





**Pear**

**NS 0432**

• 105 x 54 x 160 cm  
with leaf

W 105 cm  
D 54 cm  
H 160 cm



**Apple Tree**

**SK 0003**

• 132 x 65 x 150 cm

W 132 cm  
D 65 cm  
H 150 cm



**Corner Apple Tree**

**SK 0004**

• 65 x 65 x 150 cm

W 65 cm  
D 65 cm  
H 150 cm



**Junior Pear**

**NS 1826**

• 90 x 45 x 140 cm with leaf

W 90 cm  
D 45 cm  
H 140 cm



**Junior Fir Tree**

**SK 0011**

• 115 x 59 x 116 cm

W 115 cm  
D 59 cm  
H 116 cm



**Corner Fir Tree**

**SK 0002**

• 65 x 65 x 133 cm

W 65 cm  
D 65 cm  
H 133 cm



# TABLES & CHAIRS











# SIZE CHART

SELECT THE RIGHT SIZE OF TABLES AND CHAIRS ACCORDING TO THE HEIGHT AND AGE OF YOUR CHILD

size of table/chair	PRESCHOOL				SCHOOL			
	NURSERY							
	nr 0	nr 1	nr 2	nr 3	nr 4	nr 5	nr 6	nr 7
height in cm	80-95	93-116	108-121	119-142	133-159	146-176,5	159-188	174-207
age	1-2	2-6	4-7	6-10	8+	11+	13+	15+
seat height	21	26	31	35	38	43	46	51
table top height	40	46	53	59	64	71	76	82
colour according to size								

0	1	2	3	4	5	6	7
AGE 1-2	AGE 2-6	AGE 4-7	AGE 6-10	AGE 8+	AGE 11+	AGE 13+	AGE 15+
80-95 cm	93-116 cm	108-121 cm	119-142 cm	133-159 cm	146-176,5 cm	159-188 cm	174-207 cm
40cm 	46cm 	53cm 	59cm 	64cm 	71cm 	76cm 	82cm 





W 90 cm  
D 90 cm  
H 46-76 cm



W 69 cm  
D 138 cm  
H 46-76 cm



W 120 cm  
D 80 cm  
H 46-58 cm

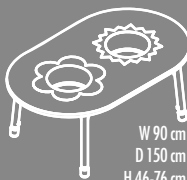

W 90 cm  
D 150 cm  
H 46-76 cm

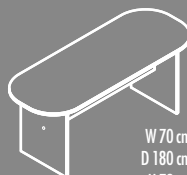

W 70 cm  
D 180 cm  
H 73 cm

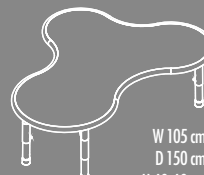

W 105 cm  
D 150 cm  
H 40-60 cm

**SPECIAL**  
WITH EXTRA  
FUNCTION



W 138 cm  
D 138 cm  
H 40-58 cm



W 110 cm  
D 63 cm  
H 40-58 cm

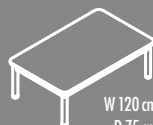

W 120 cm  
D 75 cm  
H 40-58 cm



W 75 cm  
D 75 cm  
H 40-58 cm



W 90 cm  
D 90 cm  
H 40-58 cm

**CLASSIC WOOD**  
HEIGHT-ADJUSTABLE  
WITH WOODEN LEGS



W 143 cm  
D 143 cm  
H 40-71 cm

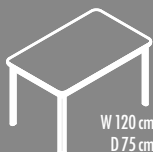

W 120 cm  
D 75 cm  
H 40-71 cm



W 75 cm  
D 75 cm  
H 40-71 cm



W 90 cm  
D 90 cm  
H 40-71 cm

**ERGO**  
WOODEN TRAPEZOIDAL-SECTION LEGS

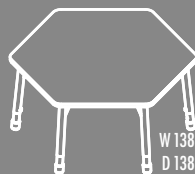

W 138 cm  
D 138 cm  
H 46-76 cm

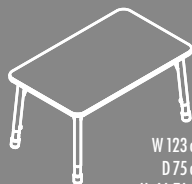

W 123 cm  
D 75 cm  
H 46-76 cm



W 75 cm  
D 75 cm  
H 46-76 cm



W 90 cm  
D 90 cm  
H 46-76 cm

**CLASSIC STEEL**  
WITH METAL LEGS  
AND ADJUSTABLE HEIGHT

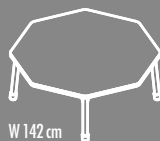

W 142 cm  
D 142 cm  
H 46-76 cm

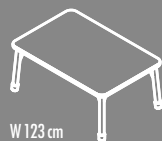

W 123 cm  
D 82 cm  
H 46-76 cm

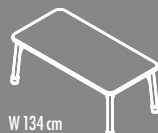

W 134 cm  
D 67 cm  
H 46-76 cm



W 82 cm  
D 82 cm  
H 46-76 cm



W 67 cm  
D 67 cm  
H 46-76 cm

**EKOSTEEL**  
WITH METAL LEGS  
WITH OR WITHOUT  
HEIGHTADJUSTMENT

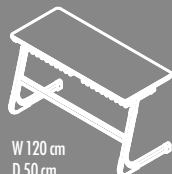

W 120 cm  
D 50 cm  
H 46-76 cm



W 60 cm  
D 50 cm  
H 46-76 cm

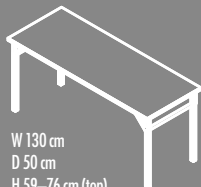

W 130 cm  
D 50 cm  
H 59-76 cm (top)



W 69 cm  
D 50 cm  
H 59-76 cm (top)

**SCHOOL DESK**  
HEIGHT-ADJUSTABLE;  
METAL FRAME

WIDE RANGE OF TABLES

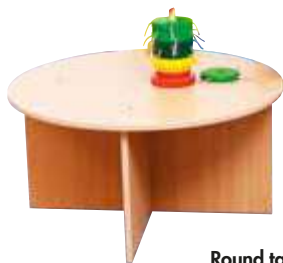

**Round table**  
**NS 0160**

For reading corners, play corners. Round top easily accessible from all sides  
• ø 60 cm, H 31 cm



height adjustable legs

**Table with container**  
**NS 0565**

A table with a large top. The cavity in the middle holds a box for art and crafts accessories or toys. When not used, the box can be conveniently and neatly covered.

- top: 120 x 80 cm; top height: 46, 52, 58 cm

PVC container



cover with handle



**kind of table**

tops and legs sold separately

**available shapes of tops**



90 cm

**tops available in colours**



**edges available in colours**



**additional accessories**

1 textile container sold with top

**top**

laminated board (D25 mm)

**legs**

sold separately  
regulated height

- 1 - 3 (46, 53, 59 cm)
- 3 - 6 (59, 64, 71, 76 cm)

- metal
- circular cross-section - ø 48 mm
- ø 48 mm
- top mounting



nonscratching, antislip foot



height adjustment  
1-3, 3-6



increased stability



safe, rounded corners



stable construction (5° inclined legs)

**tables with containers**

**Flower table**  
**NS 3743/NI**

- ø 90 cm



**Flower and Sunflower table**  
**NS 3744/B**

- 90 x 150 x 2,5 cm



**4 legs size 1 - 3**  
**NS 0067**

**4 legs size 3 - 6**  
**NS 0079**

**kind of table**

tops and legs sold separately

**available shapes of tops**

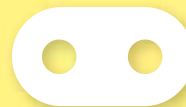

150 x 90 cm

**tops available in colours**



**edges available in colours**



**additional accessories**

2 textile containers sold with top

**top**

laminated board (D25 mm)

**legs**

sold separately  
regulated height

- 1 - 3 (46, 53, 59 cm)
- 3 - 6 (59, 64, 71, 76 cm)

- metal
- circular cross-section - ø 48 mm
- top mounting





# banana table

## kind of table

tops and legs sold separately

## available shapes of tops



138 x 69 cm

## tops available in colours



## edges available in colours



## top

laminated board (D25 mm)

## legs

sold separately

regulated height

1 - 3 (46, 53, 59 cm)

3 - 6 (59, 64, 71, 76 cm)

- metal
- circular cross-section —  $\varnothing$  48 mm
- top mounting



NS 3733BU	Beech
NS 3733CZ	Red
NS 3733ZL	Yellow
NS 3733ZI	Green
NS 3733NI	Blue



nonscratching,  
antislip foot



height adjustment  
1-3, 3-6



increased stability



safe,  
rounded corners



stable construction  
(5° inclined legs)



4 legs size 1 - 3  
NS 0067

4 legs size 3 - 6  
NS 0079



# butterfly tables

## kind of table

complete tables  
– tops with legs

## top

PVC (D 40 mm)

## legs

adjustable height:

0 – 3 (40, 46, 53, 59 cm)

- metal
- circular cross-section –  $\varnothing$  48 mm



non-scratch  
non-slip  
ferrules



height  
adjustment  
40-60 cm



metal braces  
for reinforced  
attachment



corners  
rounded for  
safety



metal frame  
for durability



62 x 122 cm



YC 9021

YC 9022

YC 9023

YC 9024

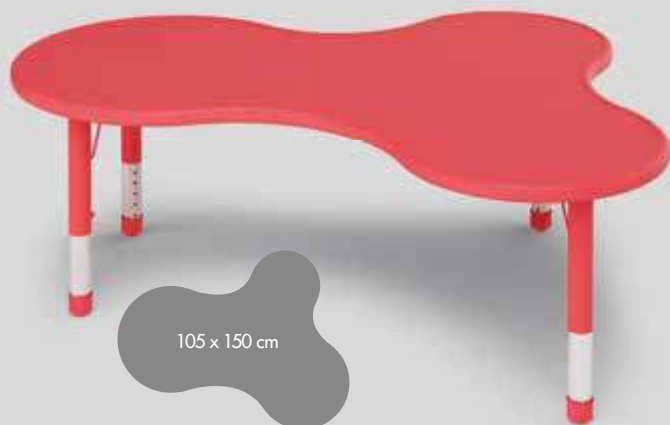

105 x 150 cm



YC 9031

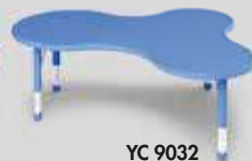

YC 9032



YC 9033



YC 9034

**ROUND**



ø 90 cm; H 40-58 cm

- NS 0742NI
- NS 0742CZ
- NS 0742ZI
- NS 0742ZL



Colour edge and wooden top

- NS 0725NI
- NS 0725CZ
- NS 0725ZI
- NS 0725ZL



Edge multiplex and wooden top

- NS 0725M



White edge and white top

- NS 0742B



**SQUARE**



W 75cm; D 75 cm; H 40-58 cm

- NS 0741NI
- NS 0741CZ
- NS 0741ZI
- NS 0741ZL



- NS 0724NI
- NS 0724CZ
- NS 0724ZI
- NS 0724ZL



- NS 0724M



- NS 0741B



**RECTANGULAR**



W 120cm; D 75 cm; H 40-58 cm

- NS 0740NI
- NS 0740CZ
- NS 0740ZI
- NS 0740ZL



- NS 0723NI
- NS 0723CZ
- NS 0723ZI
- NS 0723ZL



- NS 0723M



- NS 0740B



**TRAPEZOIDAL**



W 110cm; D 63 cm; H 40-58 cm

- NS 0738NI
- NS 0738CZ
- NS 0738ZI
- NS 0738ZL



- NS 0739NI
- NS 0739CZ
- NS 0739ZI
- NS 0739ZL



- NS 0739M



- NS 0738B



**HEXAGONAL**



ø 138 cm; H 40-58 cm

- NS 0795NI
- NS 0795CZ
- NS 0795ZI
- NS 0795ZL



- NS 0796NI
- NS 0796CZ
- NS 0796ZI
- NS 0796ZL



- NS 0796M



- NS 0795B





# TABLES

## CLASSIC WOOD

WITH WOODEN LEGS  
AND ADJUSTABLE HEIGHT



### kind of table

complete tables – tops with legs

### available shapes of tops



75 x 75 cm   120 x 75 cm   ø 90 cm   ø 138 cm   110 x 63 cm

### tops available in colours



### edges available in colours



### top

laminated board (D18 mm)

### legs

regulated height

0 – 3 (40, 46, 53, 59 cm)

- beech hardwood
- circular cross-section – ø 48 mm
- top mounting



**TABLES SOLD  
WITH LEGS**

### norms and certificates

PN-EN 1729-1 and PN-EN 1729-2

INT CERT

### School table

NS 0842/colour

With coloured edging

- top W 120 cm, H 80 cm
- table heights 58 cm, 64 cm
- 4 colours (red, blue, green, yellow)



one leg – 4 heights  
(size 0–3)

combitable system



## ROUND



ø 90 cm; W 40-71 cm



colour edge colour top



NS 2742NI



NS 2742CZ



NS 2742ZI



NS 2742ZL

Beech top colour edge



NS 2725NI



NS 2725CZ



NS 2725ZI



NS 2725ZL

Beech top  
edge multiplex



NS 2725M



white top  
white edge



NS 2742B



## SQUARE



S 75 cm; G 75 cm; W 40-71 cm



colour edge colour top



NS 2741NI



NS 2741CZ



NS 2741ZI



NS 2741ZL

Beech top colour edge



NS 2724NI



NS 2724CZ



NS 2724ZI



NS 2724ZL

Beech top  
edge multiplex



NS 2724M



white top  
white edge



NS 2741B



# TOPS

## HEXAGONAL



ø 143 cm; W 40-71 cm



colour edge  
colour top



NS 2795NI



NS 2795CZ



NS 2795ZI



NS 2795ZL

Beech top  
colour edge



NS 2796NI



NS 2796CZ



NS 2796ZI



NS 2796ZL

Beech top  
edge multiplex



NS 2796M



white top  
white edge



NS 2795B



## RECTANGULAR



S 120 cm; G 75 cm; W 40-71 cm



colour edge  
colour top



NS 2740NI



NS 2740CZ



NS 2740ZI



NS 2740ZL

Beech top  
colour edge



NS 2723NI



NS 2723CZ



NS 2723ZI



NS 2723ZL

Beech top  
edge multiplex



NS 2723M



white top  
white edge



NS 2740B



## LEGS

### SETS

- legs from beech hardwood, 4 pcs.

#### 6 leg set

NS 6040	height 0	40 cm
NS 6046	height 1	46 cm
NS 6053	height 2	53 cm
NS 6059	height 3	59 cm
NS 6064	height 4	64 cm
NS 6071	height 5	71 cm

#### 4 leg set

NS 0040	height 0
NS 0046	height 1
NS 0053	height 2
NS 0059	height 3
NS 0064	height 4
NS 0071	height 5

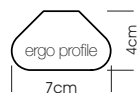

### kind of table

tops and legs sold separately

### available shapes of tops



75 x 75 cm    120 x 75 cm    ø 90 cm    ø 143 cm

### tops available in colours



### edges available in colours



### top

laminated board (D18 mm)

### legs

sold separately

nonadjustable height

- available heights  
0 (40 cm), 1 (46 cm), 2 (53 cm),  
3 (59 cm), 4 (64 cm), 5 (71 cm)
- beech wood



- top mounting



**LEGS SOLD SEPARATELY**



### norms and certificates

PN-EN 1729-1 oraz PN-EN 1729-2

**TABLE TOPS**

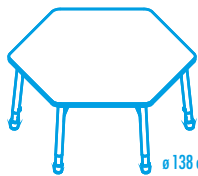

ø 138 cm  
W 46-76 cm

**HEXAGONAL TOP**

edge multiplex  
colour top

-  NS 3795NI
-  NS 3795CZ
-  NS 3795ZI
-  NS 3795ZL

Beech top  
edge multiplex

-  NS 3796

white top  
white edge

-  NS 3795B



ø 90 cm  
W 46-76 cm

**ROUND TOP**

edge multiplex  
colour top

-  NS 3742NI
-  NS 3742CZ
-  NS 3742ZI
-  NS 3742ZL

Beech top  
edge multiplex

-  NS 3725

white top  
white edge

-  NS 3742B

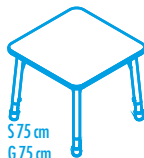

S 75 cm  
G 75 cm  
W 46-76 cm

**SQUARE TOP**

edge multiplex  
colour top

-  NS 3741NI
-  NS 3741CZ
-  NS 3741ZI
-  NS 3741ZL

Beech top  
edge multiplex

-  NS 3724

white top  
white edge

-  NS 3741B

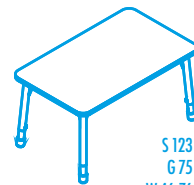

S 123 cm  
G 75 cm  
W 46-76 cm

**RECTANGULAR TOP**

edge multiplex  
colour top

-  NS 3740NI
-  NS 3740CZ
-  NS 3740ZI
-  NS 3740ZL

Beech top  
edge multiplex

-  NS 3723

white top  
white edge

-  NS 3740B





## LEGS



4 legs size 1 – 3  
NS 0067

4 legs size 3 – 6  
NS 0079



6 legs size 1 – 3  
NS 0069

6 legs size 3 – 6  
NS 0080



**LEGS SOLD SEPARATELY**



# TABLES CLASSIC STEEL

WITH METAL LEGS  
AND ADJUSTABLE HEIGHT

### kind of table

tops and legs sold separately

### available shapes of tops



75 x 75 cm



123 x 75 cm



ø 90 cm



ø 138 cm

### tops available in colours



### edges available in colours



### top

laminated board (D25 mm)

### legs

sold separately  
regulated height

1 – 3 (46, 53, 59 cm)

3 – 6 (59, 64, 71, 76 cm)

- metal
- circular cross-section – ø 48 mm
- top mounting



### norms and certificates

PN-EN 1729-1:2007

INT CERT

# TABLES EKOSTEEL

WITH METAL LEGS  
WITH OR WITHOUT EIGHT ADJUST

## kind of table

complete tables – tops with legs

## available shapes of tops



67 cm    67 x 134 cm    82 cm



82 x 123 cm    ø 142 cm



**tops available  
in colours**

beech



**edges available  
in colours**



**top**  
laminated board  
25 mm



## legs

- regulated height  
1 – 3 (46, 53, 59 cm)
- nonadjustable  
2 (53 cm), 3 (59 cm),
- metal
- circular cross-section – ø 45 mm



Octagonal ø 142 cm  
without height adjustment

53 cm	height 2	TH 2008
59 cm	height 3	TH 3008
64 cm	height 4	TH 4008
71 cm	height 5	TH 5008
76 cm	height 6	TH 6008

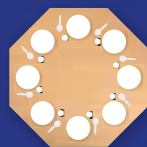

height adjustable

46-53-59 cm (H. 1-3)	TH 8008
59-64-71-76 cm (H. 3-6)	TH 9008

**FOR 8  
children**



Octagonal table

A large comfortable table for 8 children. The solid 25 mm top and sturdy angled metal legs to ensure stability and durability



Rectangular  
123 x 82 cm

Square  
82 x 82 cm

53 cm	height 2	TH 2005	TH 2002
59 cm	height 3	TH 3005	TH 3002
64 cm	height 4	TH 4005	TH 4002
71 cm	height 5	TH 5005	TH 5002
76 cm	height 6	TH 6005	TH 6002

height adjustable

46-53-59 cm (H. 1-3)	TH 8005	TH 8002
59-64-71-76 cm (H. 3-6)	TH 9005	TH 9002



Rectangular  
134 x 67 cm

Square  
67 x 67 cm

53 cm	height 2	TH 2004	TH 2001
59 cm	height 3	TH 3004	
64 cm	height 4	TH 4004	
71 cm	height 5	TH 5004	
76 cm	height 6	TH 6004	

height adjustable

46-53-59 cm (H. 1-3)	TH 8004	TH 8001
59-64-71-76 cm (H. 3-6)	TH 9004	TH 9001



# CLASSIC SCHOOL TABLES AND CHAIRS

## kind of table

complete tables

## available shapes of tops



130 x 50 cm



69 x 50 cm

## tops available in colours



beech

## edges available in colours



## top

laminated board (D 18 mm)

- top fixing – frame double-reinforced with corners and bars

## legs

nonadjustable height

3 (59 cm), 4 (64 cm), 5 (71 cm), 6 (76 cm)

- metal
- square cross-section - 25 mm

## additional accessories

plastic hooks for bags

## norms and certificates

INT CERT





### **CHAIR**

height 3 (35cm)  
NS 0013

height 5 (43cm)  
NS 0015

height 4 (38cm)  
NS 0014

height 6 (46cm)  
NS 0016



### **DOUBLE TABLE**

height 3 (59cm)  
AJE 230

height 5 (71cm)  
AJE 250

height 4 (64cm)  
AJE 240

height 6 (76cm)  
AJE 260



### **SINGLE TABLE**

height 3 (59cm)  
AJE 130

height 5 (71cm)  
AJE 150

height 4 (64cm)  
AJE 140

height 6 (76cm)  
AJE 160



# HEIGHT ADJUSTABLE CHAIRS AND DESKS

## kind of table

complete tables

## available shapes of tops



120 x 50 cm



60 x 50 cm

## tops available in colours



beech

## frame available in colours



## top

laminated board 18 mm

- top mounting



## legs

height adjustment 3 – 6 (59, 64, 71, 76 cm)

- metal

## additional accessories

basket for tables, hook for bags  
(sold separately)

## norms and certificates

PN-EN 1729-1:2007 \ INT CERT



## ADJUSTABLE SEAT HEIGHT CHAIRS

### Chair 1-2

1 – 2 (26 – 31cm)

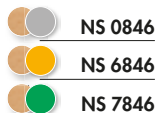

### Chair 3-4

3 – 4 (35 – 38cm)

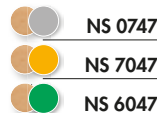

### Chair 5-6

5 – 6 (43 – 46cm)

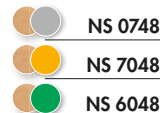

## ACCESSORIES

### Basket for books

NS 0058

- 45 x 34 x 12 cm, 1 pc.
- fits 1 and 2 person desk



### Bag hook for the school desk

NS 0052





**One student  
Desk 3-6**

- adjustable height
- 3-6 (59-76cm)

top 60 x 50 x 1,8 cm

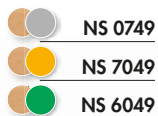

**Two Students  
Desk 3-6**

- adjustable height
- 3-6 (59-76cm)

top 120 x 50 x 1,8 cm

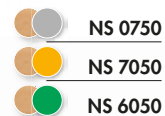

## STUDENT ADJUSTABLE DESK





# OFFICE CHAIRS



**ISO chair**

**SZ 0113**

- H 82 cm, Seat H 47 cm, W 54 cm, Seat D 42 cm



**Desk chair**

**SZ 0072**

- H 115 cm, W 63 cm, Seat W 46 cm, Seat D 45 cm, 16 kg



**Chair Rapid 5**

**DB 3005**

- seat H 43-58 cm, user height 146-176 cm



**Chair Rapid 6**

**DB 3006**

- seat H 43-58 cm, user height 159-207 cm



# CHAIRS



## WOODEN



EMMI

LILI

MIMI

## PLASTIC



SHELL

BUTTERFLY

## METAL FRAME



CLASSIC

ADJUSTABLE HEIGHT CHAIR

KAROLEK

## OFFICE



ISO

DESK CHAIR

RAPID

## kind of chair

multielement (hardwood and plywood)

## stackable

## available seat colour



## seat and backrest

- plywood

## legs

nonadjustable height

0 (21 cm), 1 (26 cm), 2 (31 cm), 3 (35 cm)

- square cross-section
- beech hardwood

## additional accessories

- safety harness (sold separately)
- armrests (only with emmi chairs)

## norms and certificates

INT CERT



**Emmi 0 with child protection**

**CH 0009**

- 21 cm seat height

**Emmi 1 with child protection**

**CH 0010**

- 26 cm seat height



Pair of braces for Emmi with armrest  
CH 0011





3 2 1 0

with armrest

size	code	seat height
0	CH 0008	21 cm
1	CH 0005	26 cm
2	CH 0006	31 cm
3	CH 0007	35 cm



3 2 1 0

without armrest

size	code	seat height
0	CH 0004	21 cm
1	CH 0001	26 cm
2	CH 0002	31 cm
3	CH 0003	35 cm







**lilli**



3 2 1 0



1 pc

size	code	seat height
0	NS 9008	21 cm
1	NS 9001	26 cm
2	NS 9002	30 cm
3	NS 9003	34 cm

2 pcs. set



size	code	seat height
0	NS 9028	21 cm
1	NS 9021	26 cm
2	NS 9022	30 cm
3	NS 9023	34 cm

**mimi**



3 2 2 1 1 0



stackable

size	code	seat height	colour
0	NS 9007	21 cm	green
1	NS 9004	26 cm	orange
1	NS 9014	26 cm	blue
2	NS 9005	30 cm	yellow
2	NS 9015	30 cm	blue
3	NS 9006	34 cm	red

## kind of chair

One element (PVC)

stackable

available colours



## legs

nonadjustable height

0 (24 cm), 1 (26 cm),  
2 (32 cm), 3 (35 cm), 4 (35 cm)

• irregular cross-section



15 mm





35 mm



# butterfly chairs

STACKABLE



	<b>0</b>	<b>1</b>	<b>2</b>	<b>3</b>	<b>4</b>					
	seat overall	height 24 cm 44 cm	seat overall	height 26 cm 51 cm	seat overall	height 30 cm 55 cm	seat overall	height 35 cm 63 cm	seat overall	height 40 cm 70 cm
	YC 0001	YC 1001	YC 2001	YC 3001	YC 4001					
	YC 0002	YC 1002	YC 2002	YC 3002	YC 4002					
	YC 0003	YC 1003	YC 2003	YC 3003	YC 4003					
	YC 0004	YC 1004	YC 2004	YC 3004	YC 4004					



**kind of chair**

multielement (metal and plastic)  
one size in one colour

**available colours****plastic seat****metal legs**

nonadjustable height

2 (31 cm), 3 (35 cm), 4 (38 cm),  
5 (43 cm), 6 (46 cm),

• circle cross-section  $\varnothing$  29 mm



stackable



self leveling foots



ergonomic profiled backrest



net protection for transport



holder for easy carrying



# CHAIRS SHELLS

Size 6  
NS 5062

Size 5  
NS 5053



Size 4  
NS 5041

Size 3  
NS 5034

Size 2  
NS 5025





## kind of chair

multielement (metal and plywood)

## stackable

## available seat colours

birch

## available leg colours



## seat and backrest

- birch plywood (D8 mm)

## legs

nonadjustable

0 (21 cm), 1 (26 cm), 2 (31 cm), 3 (35 cm),  
4 (38 cm), 5 (43 cm), 6 (46 cm)

- round cross-section  
[0,1,2 – ø 19 mm], [3,4,5,6 – ø 22 mm]
- metal

## norms and certificates

PN-EN 1729-1:2007

PN-EN 1729-2:2007

INT CERT



stackable



durable frame



# Karolek



	NS 0746/colour	NS 1774/colour	NS 2775/colour	NS 3776/colour	NS 4777/colour	NS 5778/colour	NS 6779/SZ
Size	nr 0	nr 1	nr 2	nr 3	nr 4	nr 5	nr 6
Child height w cm	80-95	93-116	108-121	119-142	133-159	146-176,5	159-188
Seat height +/- 1 cm	21	26	31	35	38	43	46
Top height +/- 1 cm	40	46	53	59	64	71	76
Colour							





Cot name clip 1 pc  
NS 0761

**Kiddy Cot set**

**NS 0754/colour/6**

- 133 x 57 x 15cm
- available in colours: , orange, green i yellow



**Kiddy Cot set blue**

**NS 0754/blue/6**

- 133 x 57 x 15cm
- available in blue colour,



**SET OF 6**

**Trolley for beds**

**NS 0758**

- suitable for kiddy cots
- maximum for 15 cots



available  
in colours



**Cover for kiddy cots**

**NS 1825**

Great to store kiddy cots. With the zips on the corners and the velcros, it can be easily adjusted to the quantity of beds. Made of durable PVC, easy to clean.

**Cot legs**

**NS 0757/colour**

- they raise the cot by 11cm.
- 4 pcs.



# KIDDY COTS



available in colours



## Kiddy Cot

NS 0754/blue

NS 0754/orange

NS 0754/green

NS 0754/yellow

Made of stable steel bars, colour elements made of PVC. The corner joiners are legs at the same time with curved edges and hidden screws out of reach for children. The fabric made of fire retardant and non-toxic PVC in the form of a dense net. The optimal density of the net causes ideal air circulation and

easy to clean surface. A modern way of straining the fabric makes it very strong even after years of use. In order to move the beds easily they need to be put on a special trolley with wheels

- 133 x 57 x 15cm
- available in colours: blue, orange, green & yellow

15 cm cot height



## Mattress for Kiddy Cots

NS2160

Designed to fit a Kiddy Cot' bed. Removable zippered cotton cover. Foam mat inside

- 123 x 50 cm thickness 5 cm





**Foldable bed**

**FB 0004**

▸ 120 x 60 x 72,5 cm, melange fabric, steel tube, with zipper entrance



**Foldable Playpen**

**FB 0005**

The mesh walls guarantee proper ventilation and constant eye contact. The added plus is a pocket for toys and an openable wall for easy access to the child and for easy exit/entry.

- W 100 cm, L 100 cm, H 80 cm, Weight 10 kg
- Very easy assembly and dismantling
- small size when folded
- a handy bag for easy carrying



**Wooden bed**

**NS 0245**

Solid and aesthetic beds made of solid wood with a varnish finish.

The foam mattress has a removable cotton cover. The beds are easily stackable.

- for easy transfer, it is recommended to fit the first bed with castors NS0255
- 128 x 67 x 21 cm



**Wheels for wooden bed**

**NS 0255**

- 4 pcs.

**Mattress for wooden cots**

**NS 0651**

Fits beds GP4001. Soft-touch cover.

- 60 x 120 cm



**Cot**  
**GP 4001**

Made of solid pinewood; slat mattress base

- 60 x 120 x 76 cm; 3 adjustable heights
- mattress sold separately





**Bedding cabinet topper**  
**NS 1822**

- 9 shelves,
- 67,5 x 38 x 98 cm

9 shelves  
31 x 36,5 x 21 cm



**Cabinet for bedding**  
**NS 1821**

- 15 shelves, 123x38x98cm,
- shelves 31x21x36,5 cm

15 shelves



doors sold separately

**Red**  
**NS 1824**

**Creamy**  
**NS 2843**

**Light Blue**  
**NS 2844**



**DOORS**

**For Add-on**  
• 48,5 x 66 cm, sold in pairs



**For Cabinet**  
• 48,5 x 111 cm,  
• sold in pairs

**Red**  
**NS 1823**

**Creamy**  
**NS 2833**

**Light Blue**  
**NS 2834**

**BEDDING CABINET**

space for 24 bedding sets

**BED & BEDDING CABINET**

space for 16 bedding sets and 16 beds



**Doors for bedding cabinet**  
• 70 x 80 cm, sold in pairs

**Crema**  
**NS 2863**

**Blue**  
**NS 2864**

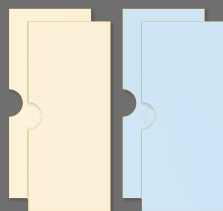

**Doors for bed cabinet**  
• 70 x 108 cm, sold in pairs

**Crema**  
**NS 2853**

**Blue**  
**NS 2854**



**Bed and Bedding Cabinet**  
**NS 2846**

- 141 x 61 x 200 cm



**Bed Cabinet**  
**NS 2845**

- 141 x 61 x 120 cm,



**Storage for beds and linen**  
**NS 3208**

- 141 x 60 x 200 cm
- space for 16 bedding sets and 16 coats on trolley

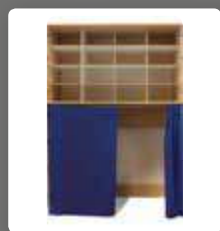

**Curtains for Bed cabinet**  
**NS 2847**

- 70 x 115 cm,
- 2 pcs.,
- blue,
- hang on straps,
- bar in set



Minty



Bed linen – green  
Minty  
NS 3648

Green Minty  
covers for bedding  
NS 3649



Bed linen – grey  
Minty  
NS 3650

Grey Minty  
covers for bedding  
NS 3651



# BED LINEN

## bed linen

pillow, pillowcase, quilt, quiltcase, sheet, sizes suitable for Kiddy cot

- pillow and quilt washable at 30°, made of 100% poly cotton
- cover and sheet 100% cotton, washable at 60°.

## covers for bedding

- pillowcase, quiltcase, suitable for Kiddy cot



Bed linen – blue  
Royal  
NS 2645

Blue Royal covers  
for bedding  
NS 2647



Bed linen – pink  
Royal  
NS 2644

Pink Royal covers  
for bedding  
NS 2646

Royal



Bed linen – Blue  
NS 1645

Blue covers for  
bedding  
NS 1647

Blank



Bed linen – Pink  
NS 1644

Pink covers for  
bedding  
NS 1646



Bedsheet  
NS 1649  
• 67 x 137 cm



Blanket  
NS 0648  
• 110 x 94 cm, polar



Yellow bedsheet  
NS 1651  
• 67 x 137 cm



Quilt  
NS 1648



Green Towel  
NS 2652  
• 25 x 50 cm

Yellow Towel  
NS 2651  
• 25 x 50 cm



Pillow  
NS 1650  
• 38 x 27 cm





### Baby high chair with table

**FB 0003**

- multi functional baby high chair with table
- material: white sponge, double lamination, density: 16, outer part: 0,5 cm, others: 1 cm
- padded seat, removable for washing;
- seat back adjustment;
- adjustable snack tray;

### High chair for babies

**FB 0002**

- the bright and comfy highchair is super easy to use and makes mealtimes fun.
- practical, removable PVC padded seat
- wipe clean seat unit
- compact fold for easy storage
- 5 point safety harness
- material: Plastic
- size: 73 x 63 x 100 cm



### Foldable automatic baby swing

**FB 0001**

- safety strap plastic swing baby rocker
- frame: steel tube with coating
- 1 toy bar with 3toys
- 3 point safety clasp
- covering: 150D Polyester Fabric and TC unfolded size: 70 x 40 x 51 cm



### Blue baby bib

**NS 2649**

- 19,5 x 30 cm
- collar 25cm
- snap fastener



### Pink baby bib

**NS 2650**

- 19,5 x 30 cm
- collar 25cm
- snap fastener



### Black & White Mat

**NS 2104**

Made of soft touch material – drill with foam filling

- 100 x 100 cm,
- washable



### Rocking chair with music

**TU 0038**

A stable interactive rocking chair convertible into a stationary seat. Button-activated calming vibrations help soothe the baby. The toy arch with 3 toys including a music box. On releasing a lock the rocker turns into a stable bed. The baby stays safe inside thanks to a lap belt. When the right time comes, the rocker can be converted into a comfortable chair.

- maximum load 27 kg; dimensions: ca 70 x 43 x 55 cm;
- requires 1 LR20 battery;
- ages: 0+



### Sleeping bag

**NS 0760**

- a comfortable soft-touch turquoise patterned sleeping bag for children. Made of high-quality cotton, Polartec lined, zipposable and with an integrated pillow.
- width when unzipped 140 cm
- length 145 cm w/ pillow, 110 cm w/o pillow
- 70% polyester, 30% cotton





### Baby feeding chair

**NS 2172**

A stable and comfortable feeding chair with wide feet for support while holding the baby or as a handy shelf for accessories. The soft backrest adapts to the shape of the adult and ensures the optimal position throughout the feeding, however long it takes.

- size: 110 x 75 x 100 cm
- made of high density foam covered with PVC fabric



big and stable

mattress sold separately



### Twin changing unit

**NS 2128**

A stable twin changing unit with raised back edge for protection. Between the mattresses there is a compartment for diapers, tissues and body care cosmetics. Underneath the top there is room for a clothes basket or a diaper pail. Both stations are adjusted in size to our pads.

- side height 92 cm, top height 87 cm, depth 70 cm
- total height of the table with the protective back 110 cm, width 138.5 cm
- colour: birchwood
- mats sold separately



### Changing mat - Green

**NS 2123**

Made of foam covered with durable easy-to-clean PVC cover.

- 50 x 70 x 15 cm

### Mat for changing pad

**NS 1906**

- 50 x 70 x 15 cm, Made of foam covered with durable easy-to-clean PVC cover.

### Yellow changing unit

**NS 1819**

Functional, comfortable and practical changing unit. Equipped with a soft mattress, 4 durable eco cardboard drawers and shelves for keeping necessary accessories. Compatible with cabinet NS1820. Made of laminated chipboard and MDF.

- 68 x 72 x 97 cm,
- 3 drawers 25,5 x 35 x 17,5 cm and 1 drawer 25,5 x 35 x 8 cm
- mattress 50 x 70 x 6 cm Needs fixing to the wall.



### Cabinet for changing unit

**NS 1820**

Compatible with changing unit NS 1819

- 58,5 x 38,5 x 81,5 cm



# CHANGING UNITS



## Changing pad - unit NS 0010

- 110 x 75 x 70 cm
- sold with mattress



sold with mattress

## Changing unit Minty NS 3207

- 67 x 75 x 100 cm

1 shelf inside



## Diaper cabinet NS 2124

- a narrow shelving unit with 20 compartments.
- each can hold about 10 nappies.
- each shelf can be individually signed for efficient segregation.
- 18 mm laminated board (birch)
- HDF shelves (white)





**Cabinet for pots**

**NS 1843**

- 82 x 38 x 84 cm,
- fits 9 pots



**Tumbler**

**TP 1625**

- 8 cm; 1 pc., mix of colours



**Cabinet for toothbrushes**

**NS 2904**

Two-level cabinet for 14 toothbrush sets. Underneath plastic double towel hooks. Framework: white. Fronts: blue laminated board.

- 80 cm x 12 cm x 55 cm,
- shelf: 9.5 cm x 9.5 cm 20 cm
- fits 14 tumblers and toothbrushes



**Finger guard**

**AV 1901**

With a doublesided self-adhesive strip it is easy and quick to attach (ca 6 min). Being transparent, it matches all colour doors. EU certified.

- dt. 1,2 m



**Edge protector**

**AV 2001**

Made of soft plastic to absorb bumps. It protects children's heads from hitting wall and furniture corners, ledges etc. Non-toxic, easy to clean and attach. EU certified.

- dt. 100 cm



**Electric socket cover**

**NS 9534**

It protects children from sticking various objects into electric sockets.

- 9 covers for 220V mains
- 3 keys for removing covers



**Corner guard**

**NS 9535**

Large, soft, transparent plastic guards for dangerous furniture corners. A doublesided self-adhesive strip for easy attachment.

- 4 pcs.



### Board with hangers

**NS 2905**

- blue MDF board + yellow plastic double hooks
- 124 x 12 x 4 cm,
- 10 double hooks



### Bathroom shelf

**NS 1698**

- 86 x 37 x 21 cm, without tumblers, 6 double hooks

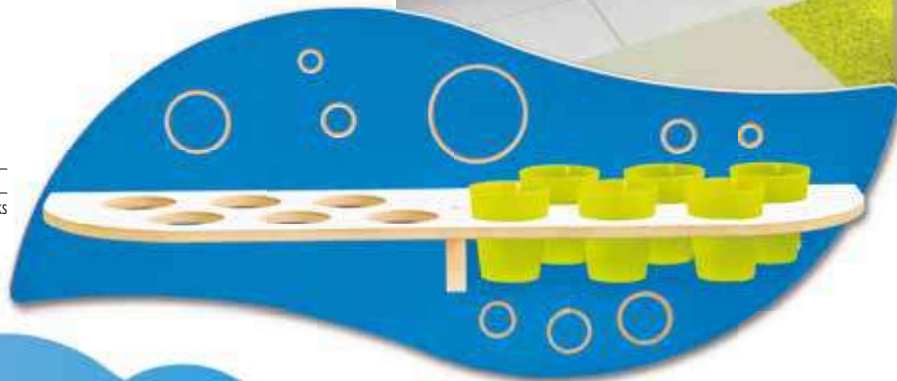

### Cloud

**NS 2901**

### Brush

**NS 2899**



### Tooth paste

**NS 2898**



### Bathroom shelves

Shelves for accessories essential for dental health.

- will hold 5 toothbrush cups,
- plastic handles,
- 53 x 15 x 10 cm – Brush,
- 54 x 15 x 17 cm – Tooth paste
- 72 x 13 x 30 cm – Cloud
- without tumblers

# soft mats

## Earth

NS 2110

A colourful round mat with environmental decorative motifs. Made of velour-covered foam, this soft mat effectively isolates toddler from the ground. Black bottom to save cleaning. Supplied with a zipper cover.

- ø 150 cm, 1,5 cm thick
- ages: 6 months +
- cover washable 40°C



## 2 in 1 fitness frame piano

TU 0037

This floormat with an interactive piano will grow with the baby. In the first months, when the baby lies on the back it can play with the toys on the arch and press the keyboard keys with its feet. When it starts to lift its head and lie on its tummy, it can face the keyboard. When it has learned to sit, the piano can be set up in the table position. The keyboard panel can also be detached and mounted onto the bed.

- keyboard with 4 large keys and a function key, 5 rattles with hooks (including 1 music box)
- mat size: 70 x 83 x 45 cm
- requires 3 AA batteries and 3 AG13 1.5V batteries (not included)
- ages: 6 mths+



## Mirror Mat – Flower

NS 2111

A soft two-piece mat with 5 petal-shaped cushions on top of a round soft foam-filled bottom part. The top piece is wadded and zippered. In the middle of the flower there is a safe Plexiglas mirror (diameter 35 cm).

- ø 145 cm, 10 cm thick
- ages: 6 months +
- cover washable 40°C



Made of padded foam covered with washable soft fabric, removable zippered cover.  
60 x 38 cm

## Pillows



**Cat**  
NS 1973



**Whale**  
NS 1971

## Sensory Cushions

NS 2129

- soft rustling cushions in the shape of a circle, triangle, rectangle and square. The vivid colours attract children's attention and the rustling sound encourages them to play.
- circle diameter 30 cm, triangle side 30 cm, square 30 x 30 cm, rectangle 40x28 cm
- granulate inside

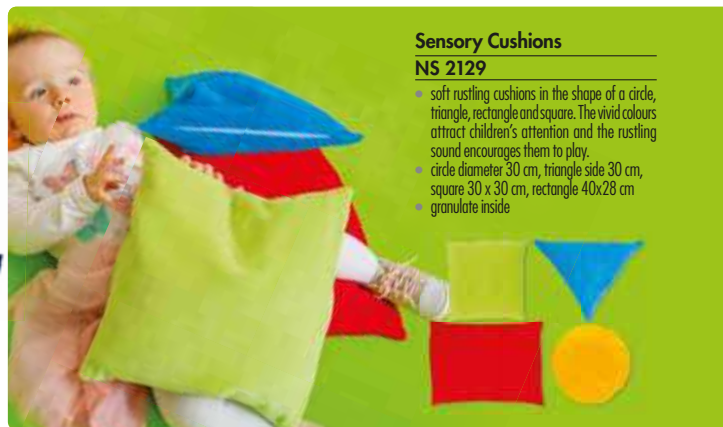

## Butterfly

NS 1895

- 4 bolsters in different colours
- 140 x 120 cm



## Bee

NS 1908

- anti-slip bottom
- made of denim with foam insert
- flaps filled with polystyrene beads
- 135 x 115 x 10 cm



### Round mattress with pockets and mirrors

NS 2199

A very comfortable soft mattress for toddlers to roll and crawl freely. The added mirrors stimulate sight, help develop self-awareness and interpersonal social skills. The small pockets will hold illustrations or suggested worksheets for stimulating curiosity and the will to explore. The mattress is padded with soft foam and covered with coloured PVC fabric.

- mattress ø 137 cm x 3 cm
- 1 round mirror ø 27 cm
- 3 square mirrors 17 x 17 cm
- 3 pockets 12 x 12 cm.



### Flower

NS 1907

Mat made of soft-touch material – drill with foam filling.

- inside 3 removable mattresses
- antislip bottom
- made of durable PVC fabric
- ø 140 cm, H 10 cm



### Texture Track

NS 2150

A set of sensory foam shapes for children to arrange.

- made of PVC covered foam
- 10 squares: 40 x 40 x 3,5 cm
- 4 quarters: 40 x 40 x 3,5 cm
- 1 circle: ø 40 cm



# seats, cushions, activity corners

Large flower and lifebelt shaped cushions  
filled with foam cuttings.

- ø 100 cm, H20 cm



**Flower**  
NS 1885



**Lifebelt**  
NS 2158



**Frog**  
NS 0219

- made of padded foam covered with washable denim fabric, removable zipped cover.
- ø 100 cm



**Hippo**  
NS 0220

- made of padded foam covered with washable denim fabric, removable zipped cover.



**Seal**  
NS 2193

• 70 x 100 cm



**Whale**  
NS 2196

• 140 x 65 cm



**Penguin**

NS 2195

• 65 x 95 cm

# sea pillows



Soft cushions Penguin, Seal, Octopus and Whale will be ideal for floor play and they will help children quieten down and relax while listening to fairy tales.

- zippered velour cover washable at 30°C.
- 70x100 cm.
- various uses: sit on them, lie on them, play with them easy to keep clean (zipped machine washable cover) certified material (velour, cotton wool padding, removable cover)





**Octopus**

**NS 2194**

• 70 x 110 cm



**Doggy**

**NS 2108**

The dog has a nose that squeaks cheerfully, pellet-filled ears and soft elastic paws.



**Bunny**

**NS 2109**

The bunny has a tail that squeaks and elastic ears and paws.

**Sensory cushions**

Large and soft cushions mainly for toddlers. The soft snouts, flexible legs and squeaky elements encourage kids to cuddle the toy animals. Made of PVC fabric with velourelements. Stuffed with shredded foam.

• 70 x 90 cm



# rehabilitation cushions



**Small**  
**NS 0639**

Helps in developing movement coordination.

- 100 x 49 cm
- filled with granulate



**Big**  
**NS 0585/colour**

- 150 x 60 cm, weight 4 kg



available  
in colours

## Teddy Bear

**NS 2107**

The bear has soft velour ears, squeaky nose and long velcroed arms with which to hug anyone who sits down on him.

## Clown

**NS 2106**

The clown has a soft velour cap, loopy hair, long arms with a bell, laced shoes, large buttons and a red nose which squeaks cheerfully when pressed.

## Sensory pears

Comfortable pouffes with sensory elements (bells, pipes, velcros, string loops, laces). Made of PVC fabric. Filled with styrofoam, they can easily adapt to the sitter's position.

- 60 x 52 x 28 cm
- 2,2 kg



## With handle

**NS 2230**

- 150 x 60 cm
- weight 4 kg



# poufs fruits and vegetables

- 60 x 50 x 28 cm
- foam-pellet padding
- cover: PVC fabric



Strawberry  
NS 2214



Aubergine  
NS 2215



Pear  
NS 2216



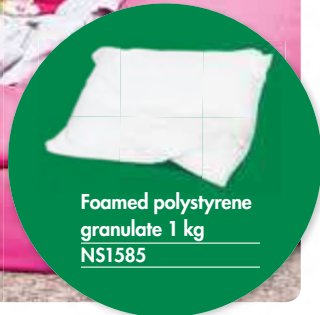

Foamed polystyrene  
granulate 1 kg  
NS1585

## smiley beanbags

- made of colourful PVC filled with polystyrene beads.
- ø 65, H 63 cm
- 3 kg



Blue & pink  
NS 1891



Dark blue & orange  
NS 1892



Green & yellow  
NS 1889



Green & dark green  
NS 1890

## animal beanbags

- 60 x 52 x 28 cm
- 2,2 kg



Blue Seal  
NS 1990



Purple Seal  
NS 1988



Duck  
NS 1986



Blue Penguin  
NS 1985



Tiger  
NS 1989



Black Penguin  
NS 1987

### Seats Llama and Fox

Llama and Fox are colourful, comfortable, springy seats will create a joyful attractive play corner in a nursery school. Their simple construction and right choice of materials ensure comfortable and safe

use. The PU foam padding guarantees softness and durability and the PVC easy-to-clean covers are nice to the touch. The animal symbols are printed.

Dimensions:

- fox 73,5 x 28 x 53 cm,
- llama 71 x 28 x 75 cm



Llama  
NS 2227



Fox  
NS 2228



### Seat (Carrot)

NS 2213

- 99.3 x 49.5 x 26 cm
- foam padding, printed PVC cover



### Caterpillar

NS 2229

The seat will additionally make an attractive element in gymnastic exercises, play and relaxation. The high-durability PU foam padding ensures high resistance to pressure and provides comfortable sitting. Easy-to-clean PVC cover.

- 119 x 25 x 40 cm.

## animal poufs

• ø 35, H 30 cm

Cow  
NS 1977



Hen  
NS 1978



Red Sprite  
NS 2141



Cat  
NS 1976



Frog  
NS 1975

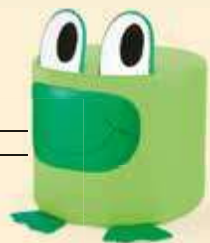

Pig  
NS 1974



Blue Sprite  
NS 2140



Sea animals soft seats  
NS 0691



• set of 3, ø 30 H 8 cm

Animals soft seats  
NS 0692



• set of 3, ø 30 H 8 cm



Numbers soft seats  
NS 0690

• set of 9, ø 30 H 8 cm



Emotions seats  
NS 1897

• foam filling, PVC cover.  
• ø 30 cm, H 8 cm.  
• 6 pieces (each featuring a different emotion)



### Mobile platform with softplay seats

NS 2220

- a mobile platform from waterproof plywood with 12 round foam seats.
- platform 80 x 39 x 23 cm, 12 seats in 12 colours 32 x 5 cm.
- foam padding, durable PVC cover.



### Softplay seats

NS 2221

- 12 pieces in 12 colours; 32 x 5 cm.
- foam padding, durable PVC cover.



### Bean bag seats

NS 2163

These round poufs will serve as seats when playing on the floor or as chair cushions for more comfort.

- 6 pcs., ø 35 x 4 cm,
- filled with granulate; PVC cover

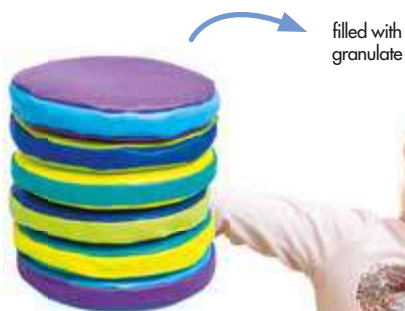

filled with granulate

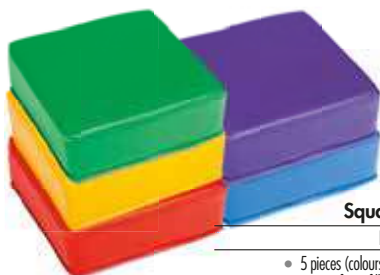

### Square seats

NS 1898

- 5 pieces (colours randomized)
- foam filling, PVC cover
- 30 x 30 x 10 cm.





### Jungle seats

**NS 2200**

A set of 8 foam discs with images of animals will come in useful

both during play and educational activities. Interesting motifs on comfortable seats are likely to be inspirational for children. The discs are filled with high-quality foam

and the PVC cover is easy to clean.

- 8 seats with different printed animals
- pVC cover
- fit the container on casters
- ø 35 H 3 cm



### Roadsigns seats

**NS 2134**

- 10 signs foam seats.
- pVC cover.
- fit container on casters.
- ø 35 H 3 cm,



### Containers

A container ideally fitted to store our round foam seats as well as other toys or blocks. Sturdy chipboard base with 4 casters. Polyester-covered HDF walls are fixed to each other and to the base with strong velcros. Additionally, one wall can be lowered when unvelcro'd.



#### Small

**NS 1933**

- 38 x 38 x 46 cm

#### Big

**NS 2933**

- 38 x 38 x 80 cm





### Foam lounge Rainbow

NS 1991

- 170 x 86 x 30 cm
- 6 pcs.
- all shapes can be joined together with Velcro to form a circle or can be used separately

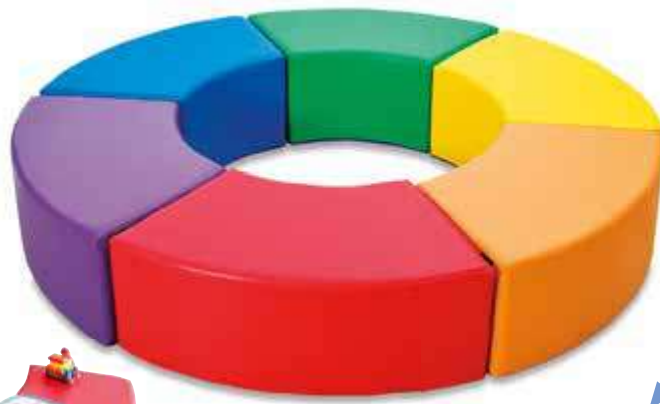

Rainbow combines to a circle creating a small, closed space

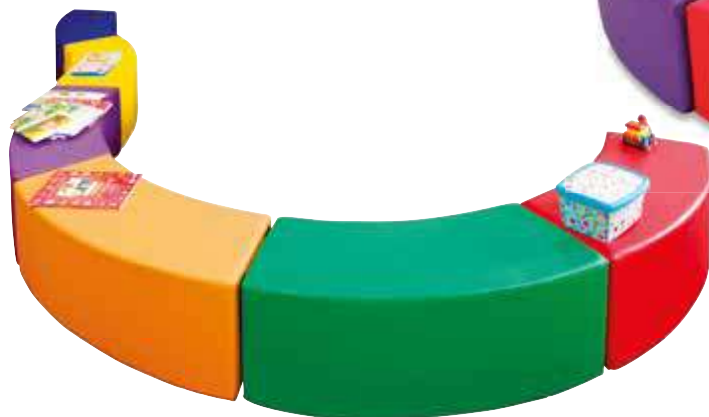

### Foam lounge Wave

NS 1984

- 1 piece 100 x 40 x 35 cm
- 6 pcs. total length 537 cm
- all shapes can be joined together with Velcro to form a wave or can be used separately



PVC  
phtalate free



**Rainbow caterpillar**

NS 1992

- set of 7 elements
- ø 35 x 30 cm



**Clever kidney-bean**

NS 1970

- 5 pcs, height from 14 to 42 cm

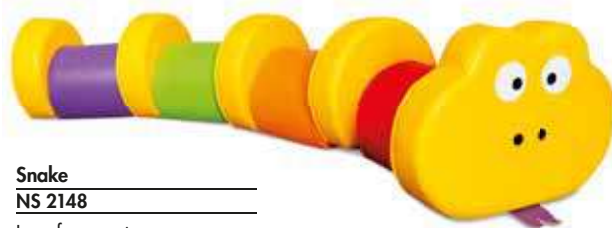

**Snake**

NS 2148

Long foam seat can serve as an obstacle course.

- 9 velcro-fastening elements
- total length 170 cm



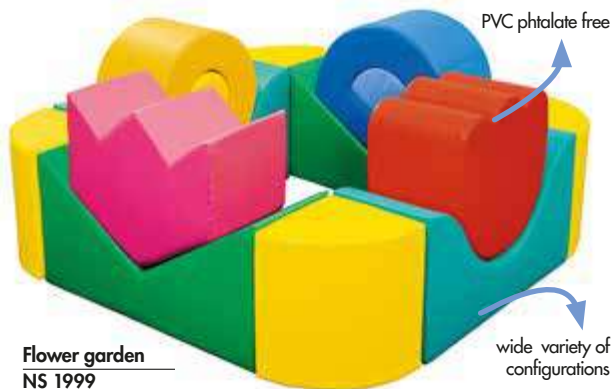

PVC phthalate free

wide variety of configurations

**Flower garden**  
**NS 1999**

- 140 x 140 x 60 cm
- 12 elements made from foam covered with PVC fabrics

**Maxi sofa**  
**Różyczka**  
**NS 0597**

- High density foam covered with PVC fabric,
- 90 x 45 x 55cm



**Maxi armchair Olaf**  
**NS 0596**

- 55 x 45 x 55 cm,
- seat H 25 cm



**Lounge suite Dolphin**  
**NS 0598**

- 2 armchairs 48 x 55,2 (seat height 24 cm),
- table 67,2 x 36 x 24 cm



**Activity corner**  
**NS 1969**

- 110 x 110 x 47cm,
- 5 pcs made from foam covered with PVC fabrics





**Armchair**  
**NS 2205**

- 50 x 76 x 42 cm,
- seat height: 25 cm

**Sofa**  
**NS 2204**

- 38 x 42 x 50 cm,
- seat height: 25 cm



**Cube**  
**NS 2206**

- 42 x 42 x 38 cm



### Jungle seats

A set of light and functional foam poufs to complement our latest furniture line Jungle. At present we offer an armchair, a sofa and a cube which are great to fill space. Made of high-quality microfibre-covered foam. All pieces have easy-to-clean zipped covers.



**Round table**  
**NS 0160**

For reading corners, play corners. Round top easily accessible from all sides

- ø 60 cm, H 31 cm



## soft sofas

- made of high-density foam covered with PVC fabric.
- non-slide bottom for prevention from accidental shifting.



**Mouse**

**NS 2170**

- 124 x 80 x 72 cm
- seat height 30 cm

**Pouf cheese**

**NS 2171**

- 41 x 46, 1 pc.
- seat height 30 cm



**Red Throne Sofa**

**NS 2138**

- 101 x 45 x 71 cm,
- seat height 25 cm

**Green Throne**

**NS 2191**

- 66 x 45 x 72 cm,
- seat height 26 cm



**Bus**

**NS 2161**

The double-sided sofa with a backrest will seat up to 8 children.

- 110 x 90 x 72 cm,
- seat height 25 cm, seat depth 33 cm

# Soft Sofas

available in colours:

-  BL light blue
-  CZ red
-  JZ yellow
-  PO orange
-  RO pink
-  ZI green



Seat H 17cm



Armchair

NS 1521/colour

- 30 x 28 x 32 cm
- seat high 17 cm



Sofa

NS 1522/colour

- 60 x 28 x 32 cm
- seat high 17 cm

Seat H 25cm



Armchair

NS 1508/colour

- 35 x 40 x 45 cm
- seat high 25 cm



Big corner sofa

NS1529/colour

- 110 x 110 x 45 cm

sitting place  
for 5 children



Pouf

NS 1509/colour

- ø 30, H 25 cm
- seat high 25 cm



Sofa

NS 1507/colour

- 110 x 40 x 45 cm
- seat high 25 cm



Cube

NS 1506/colour

- 40 x 40 x 25 cm, seat high 25 cm



**Seat H 32cm**



**Sofa**  
**NS 1502/colour**  
 • 120 x 52 x 60 cm  
 • seat high 32 cm



**Pouf**  
**NS 1501/colour**  
 • ø 30, H 32 cm  
 • seat high 32 cm



**Armchair**  
**NS 1504/colour**  
 • 40 x 52 x 60 cm  
 • seat high 32 cm

**Seat H 38cm**

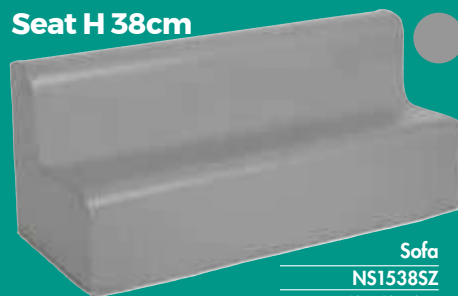

**Sofa**  
**NS 1538SZ**  
 • 134 x 59 x 69 cm  
 • seat high 38 cm



**Armchair**  
**NS 1537ZI**  
 • 44 x 59 x 69 cm  
 • seat high 38 cm



**Cube**  
**NS 1540PO**  
 • 36 x 36 x 38 cm, seat high 38 cm



**Pouf**  
**NS 1539NI**  
 • ø 35, H 38 cm  
 • seat high 38 cm



Giraffe



Jungle



Butterflies



Arabeska





# CLOAKROOMS



Crayon



Harmonia



Vita



Rainbow



School



**Board with hangers**

**NS 2905**

- blue MDF board + yellow plastic double hooks
- 124 x 12 x 4 cm,
- 10 double hooks



**Reindeer. Hook rail.**

**NS 1726**

- cloakroom accessory with 5 double hooks
- 92 x 1,2 cm x 24 cm

wall-mounted



each hook has three arms

**Wood. Hook rail.**

**NS 1727**

- cloakroom accessory with 5 double hooks
- 92 x 1,2 cm x 27 cm

mdf board application

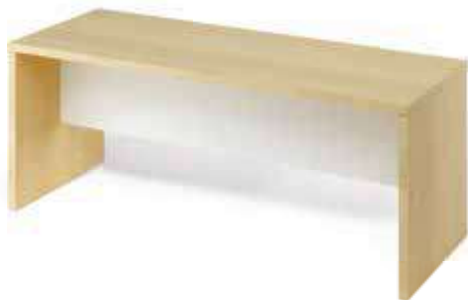

**Harmonia bench**

**NS 1725**

- 92 x 33 x 36 cm

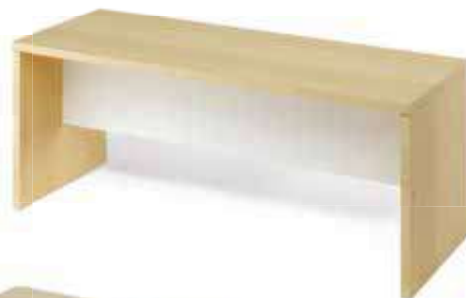

**Cloakroom seat**

**NS 1718**

A stable seat made of chipboard with foam padding.

- 100 x 40 x 43 cm



top colours

● NS 0325

● NS 0325/1

● NS 0325/2

● NS 0325/3

● NS 0325/4

**Bench**

**NS 0325**

steel frame and legs

120 x 36 x 34 cm

seat 25 mm thick





### Cactus for shoes

#### NS 1720

- a rack for 12 pairs of rubber boots.
- ø 80 cm H 160 cm



### Shelf

#### NS 0583A

- 120x21 x 28 cm

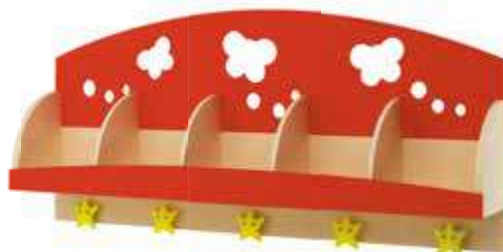

wall-mounted

### Bench + shelf

#### NS 1584

- NS 0584A + NS0583A



### Bench

#### NS 0584A

- 120x50x30 cm

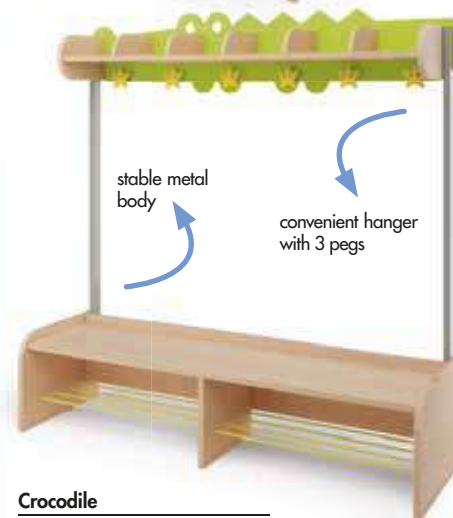

stable metal body

convenient hanger with 3 pegs

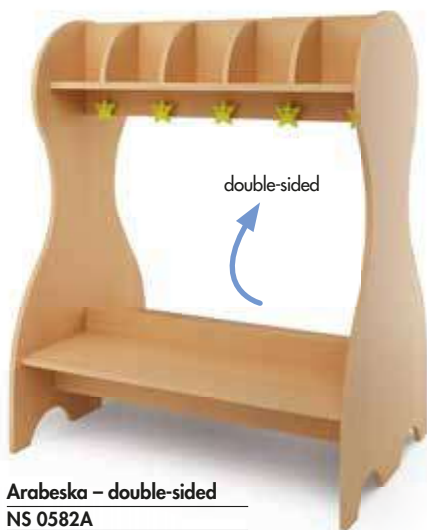

double-sided

colour beech

### Arabeska – double-sided

#### NS 0582A

- for 10 children, 105 x 75 x 131 cm



### Arabeska – one-sided

#### NS 0582

- for 5 children, 105 x 36 x 131 cm

### Crocodile

#### NS 0060

light structure on a sturdy metal framework; 6 small shelves for caps and a shoe rack. Coloured snake- and crocodile-shaped backboard in MDF; birch finish with multiplex edging.

- 136 x 42 x 142 cm



# rainbow cloakroom

functional cabinets for children's clothes and shoes. The specially designed shaped cut-outs for opening ensure essential air flow.



hook star

**Rainbow Cloakroom with  
hooks and shelf**  
NS 0468/A

• 130 x 35.4 x 172 cm



**Rainbow Cloakroom with  
shelves**  
NS 0468/F

• 130 x 35.4 x 172 cm

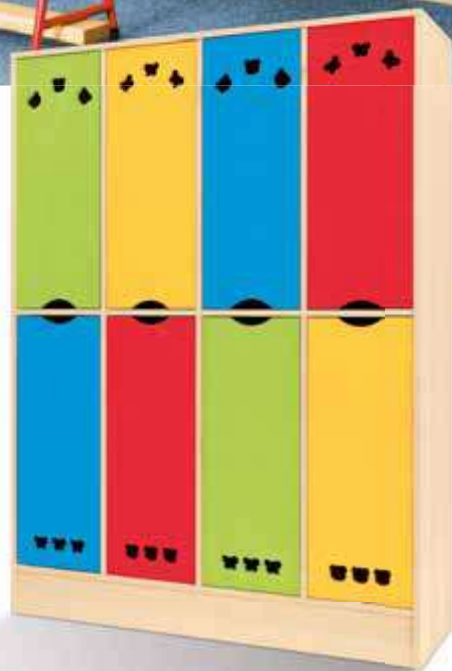

# Cloakroom Harmonia



**Harmonia 3**

**NS 0752**

• 78 x 50 x 140.5 cm, bench H 26 cm



**Harmonia 6**

**NS 0751**

• 154 x 50 x 140.5 cm, bench H 26 cm

This light beech cloakroom has practical hooks, an openwork compartment for shoes which helps keep the floor free from rainwater and dirt. The additional back panel can hold an identification for each child.



# BENCHES

## Bench 6

NS 5225

• 136 x 35 x 29 cm



## Bench 3

NS 5125

• 73 x 35 x 29 cm



## Corner Bench 4

NS 5325

• 64 x 64 x 29 cm



## Shelf 3

72 x 26 x 21 cm

- NS 5110 yellow
- NS 5111 light blue
- NS 5112 blue
- NS 5113 green
- NS 5114 red



3 hooks star

## SHELF 3



## Shelf 6

134 x 26 x 21 cm

- NS 5210 yellow
- NS 5211 light blue
- NS 5212 blue
- NS 5213 green
- NS 5214 red



6 hooks star

## SHELF 6



## Corner shelf 4

60 x 64 x 21 cm

- NS 5310 yellow
- NS 5311 light blue
- NS 5312 blue
- NS 5313 green
- NS 5314 red



4 hooks star

## CORNER SHELF 4





# Crayon cloakroom unit

This series combines functionality and economy of space. Open shelves are a great solution for a small cramped room where easy access to things saves time and makes changing clothes and

shoes easy. The triple coat hook will easily hold coats and shoe bags and the rack under the bench will help keep shoes under control.

available in colours



**Cloakroom 3**  
75 x 35 x 132 cm

-  NS 5100 yellow
-  NS 5101 light blue
-  NS 5102 blue
-  NS 5103 green
-  NS 5104 red

3 hooks star



**CLOAKROOM 3**



**Cloakroom 6**  
138 x 35 x 132 cm

-  NS 5200 yellow
-  NS 5201 light blue
-  NS 5202 blue
-  NS 5203 green
-  NS 5204 red

6 hooks star



metal frame

**CLOAKROOM 6**

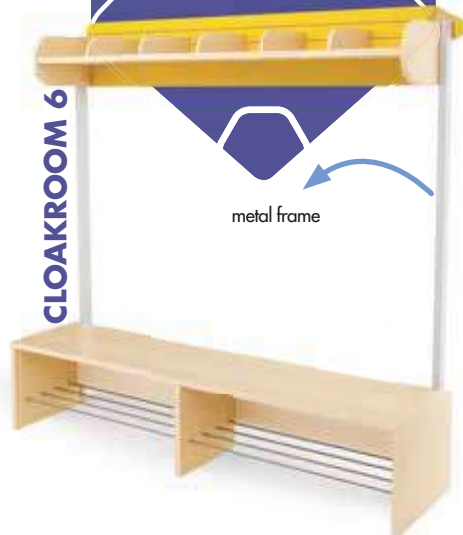

**Corner Cloakroom 4**  
64 x 66 x 132 cm

-  NS 5300 yellow
-  NS 5301 light blue
-  NS 5302 blue
-  NS 5303 green
-  NS 5304 red

4 hooks star



**CORNER CLOAKROOM 4**



# Vita

## cloakroom

Thanks to their different widths of its modules, the cloakroom Vita can be adapted to every room. With little space available, it is worthwhile organizing every

square inch. The new corner version of Vita cleverly combines simple modules to use corner space effectively.

- doors in 4 colours; sold separately



W 69 cm  
D 44 cm  
H 131 cm



W 113 cm  
D 44 cm  
H 131 cm



W 135 cm  
D 44 cm  
H 131 cm



W 69 cm  
D 69 cm  
H 131 cm



## Doors

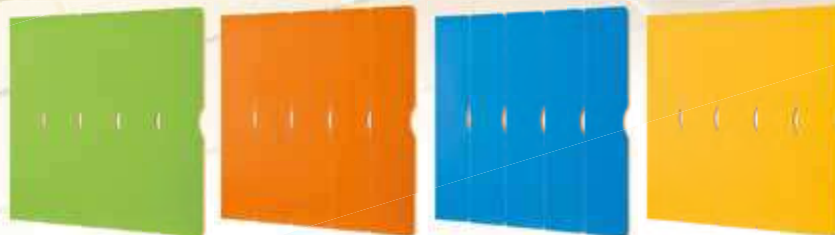

**Green**

**Orange**

**Blue**

**Yellow**

3pcs. for NS 1875

**NS 1876**

**NS 1878**

**NS 1877**

**NS 1735**

5pcs. for NS 1730

**NS 1731**

**NS 1733**

**NS 1732**

**NS 1734**

6pcs. for NS 1879

**NS 1880**

**NS 1882**

**NS 1881**

**NS 1736**

4pcs. for NS 2910

**NS 2912**

**NS 2914**

**NS 2913**

**NS 2911**





**tops  
included**

**doors sold separately**



star hangers in  
all cloakrooms

**Vita 3**  
**NS 2943**  
• 69 x 44 x 131cm



**Vita 5**  
**NS 2945**  
• 113 x 44 x 131 cm



**Vita corner 4**  
**NS 2944**  
• 69 x 68 x 131cm



**Vita 6**  
**NS 2946**  
• 135 x 44 x 131cm





### Upright Backpack Storage Unit NS 2125

A unit with 3 shelves (colour: beech) to hold about 9 backpacks. Extra space available with an extension. The top corners are rounded and the unit can be fixed to the wall, which makes it comfortable and easy to use.

- W 93.6 cm, D 40 cm, H 135.6 cm

### Upright Backpack. Storage Unit Extension NS 2126

An extension to the backpack storage unit in beech colour. Consists of a side wall and 3 shelves. Easy and safe to use thanks to the rounded top corners and the possibility of wall fixing

- W 93.6, D 40 cm H 135,6 cm

# SCHOOLBAG STORAGE



compartment:  
40 x 42 x 30 cm

### Backpack Storage Unit NS 2127

A unit with 12 shelves for storing down standard backpacks. Made of a laminated board in birch colour. Comfortable and easy to use thanks to its rounded corners and wall attachability.

- W 127 cm, D 43.5 cm, H with the protective board 152 cm, w/o 118 cm



### Chest for sports equipment NS 2906

A practical box with a lid and on castors for easy

storage of sports equipment indoors. Padlockable. MDF chipboard in grey and orange.

- 138 cm x 63 cm x 70 cm.





**Set E**  
**NS 3028**

- 35 pcs.; 5 x 5,5 cm



**Set B**  
**NS 0936**

- 25 pcs.; 4,7 x 5,6 cm



**Set A**  
**NS 0935**

- 25 pcs.; 4,7 x 5,6 cm



**Set C**  
**NS 0933**

- 25 pcs.; 4,7 x 5,6 cm



**Set F**  
**NS 3027**

- 35 pcs.; 5 x 5,5 cm



**Set D**  
**NS 0934**

- 25 pcs.; 4,7 x 5,6 cm

**ID stickers**



**Drawstring bag**  
**NS 0118**

A comfortable bag for shoes or gym kit.

- made of drill
- 44 x 29 cm, 1pcs.

**Clothes hook Star**  
**OK 7000**

- 1 pc.; 6,6 x 6,9 x 2,7 cm

All our metal hooks in cloakrooms and bathroom shelves have been replaced with a modern universal hook Star. The new hook has three arms for clothes, accessories and towels. Their ergonomic form, gently rounded edges and joyful design are an ideal solution even for the youngest ones.



**Self-adhesive ID photo frames**  
**NS 0353**

- 5pcs., 7 x 8cm



**Self-adhesive name tags**  
**NS 3049**

- 30 pcs 6 x 2 cm with a slot for child's name



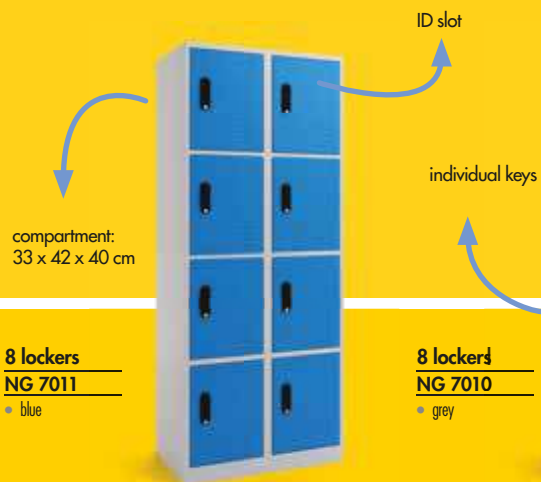

**8 lockers**  
**NG 7011**

- blue



**8 lockers**  
**NG 7010**

- grey



**Swing Door Cabinet**  
**NG 9010**

- 2 locks
- 2 shelves
- 90 x 40 x 185 cm



**4 lockers**  
**NG 6011**

- blue

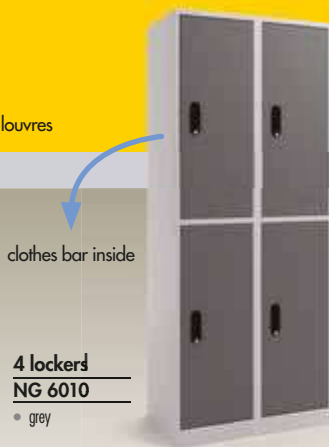

**4 lockers**  
**NG 6010**

- grey



**compartments:**  
**33 x 42 x 84 cm**

**4 lockers**  
**NG 6012**

- yellow

**Master key for lockers**  
**NG 6010W**

Master key for lockers A key for the head person to open all lockers.



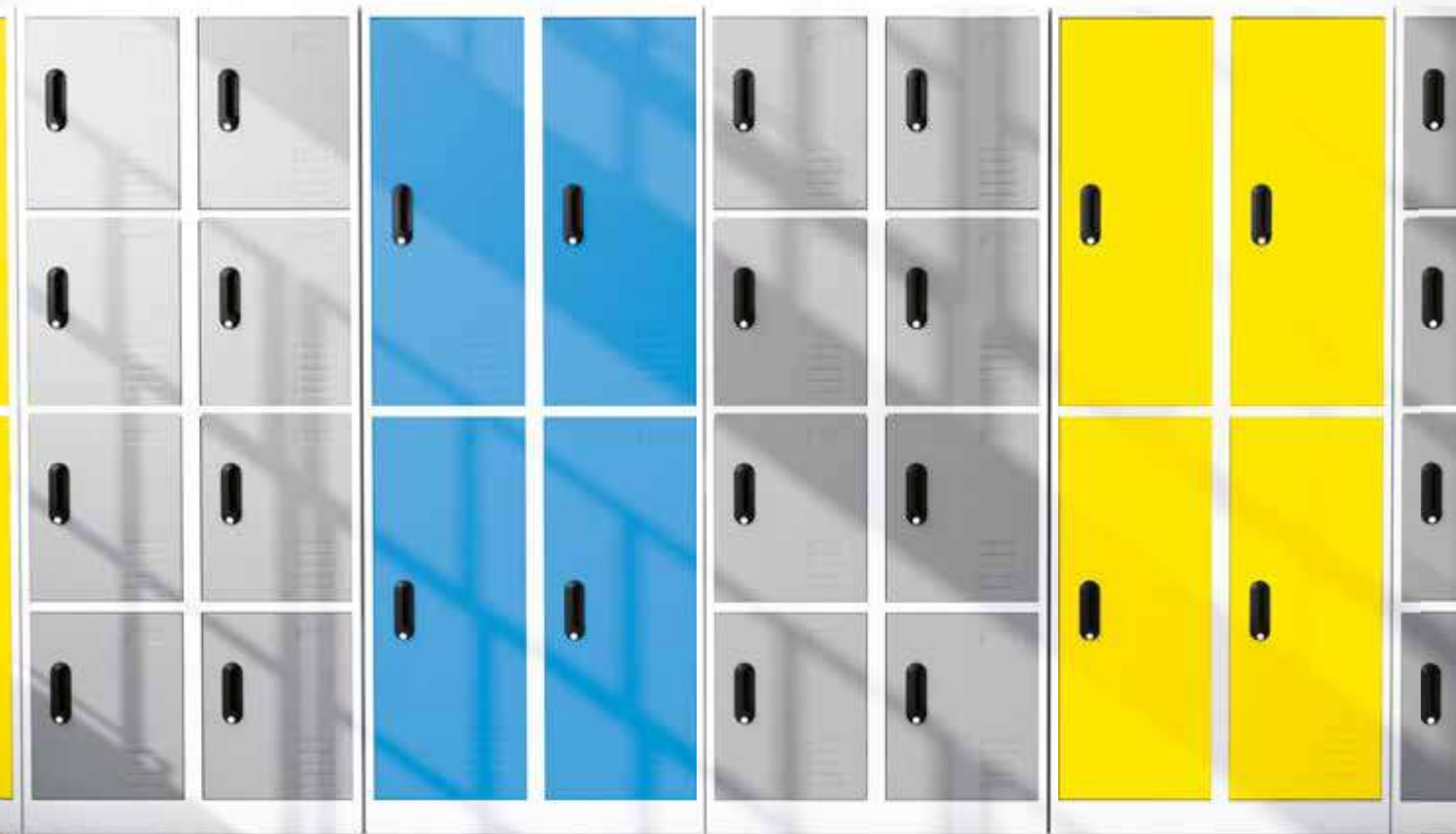

## METAL CLOAKROOMS

Metal cloakrooms with two, four or eight spacious lockers. The doors have name card slots and ventilation holes. Each locker with a hanger bar. The heavy-duty cloakroom is powder coated and corrosion resistant.

- 76 x 45 x 185 cm
- small locker 33 x 42 x 40 cm
- medium locker 33 x 42 x 84 cm
- tall locker 33 x 42 x 170 cm



**Desk**  
**NG 5001**

White metal desk with 3 drawers and a keyboard tray. Laminated fireproof MDF top (white; T 2,5 cm). All other elements are made of 0.7 mm steel and powder coated.

- 120 x 70 x 75 cm



**Cabinet**  
**NG 3002**

The body of the cabinet is made of 0.7 mm power-coated steel. Upper part - glass door w/lock; lower part - steel door with lock. Movable metal shelves.

- 90 x 40 x 185 cm



**Filing cabinet**  
**NG 3004**

- 45 x 62 x 133 cm
- - 4 jumbo drawers
- - central lock

## METAL CABINETS

Metal cabinets with lockable glass doors and a metal desk with a fireproof top can be used in a biology lab and the doctor's office. All metal parts are powder coated for enhanced resistance to corrosion, chemicals, high temperature and mechanical damage.

available in colours

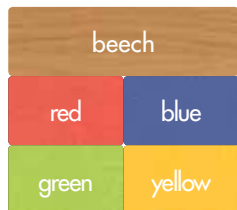

# desk Kasia



## Desk Kasia NS 0798/colour

A functional, aesthetically pleasing, work-friendly desk for a classroom or teacher's room. The natural light beech and the front veneers in the colours of the tables and chairs create a unique teamwork atmosphere.

- 120 x 75 x 76 cm





**Teacher's Desk for computer**  
**NS 2511**

A desk with a pull-out keyboard shelf, a cable hole and lockable compartment for computer.

- 120 x 55 x 76 cm
- birch laminated board



**Under Desk Drawer Cabinet**  
**NS 2512**

A cabinet on castors with three lockable drawers.

- 34 x 45 x 60 cm
- birch laminated board

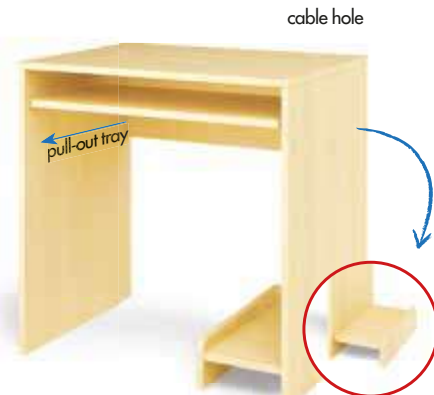

**Student Desk**  
**NS 2510**

With computer shelf. The desk has a pull-out keyboard shelf and a cable hole.

- 85 x 55 x 76 cm
- birch laminated board

The shelf can be attached on the inner or outer side.

## info desk





available in colours	green
orange	creme
yellow	blue



### Ala's Desk NS 1500/colour

A light comfortable stable desk pleasing to the eye. It has a large drawer.

- 80 x 47,5 x 76 cm



### Corner desk prima (left/right-handed)

- this large functional desk in an all-matching colour complements the prima furniture series. Together with other items from the series, it allows the user to create ergonomic sets to meet individual needs and room sizes. With the L-shaped top the work area can be used more effectively. Laminated particleboard with birch or beech finish. Left or right-handed.
- 155 cm x 110 cm x 75 cm.

Prima Desk Left  
NB 6101

Prima Desk Right  
NB 6201

Prima Desk Left  
NB 6102

Prima Desk Right  
NB 6202



### Flamingo desk NS 2820

- one lockable cabinet (two shelves inside).
- desk: overall 120cm x 52 cm x 76 cm; cabinet 120cm x 52 cm x 76 cm
- birch



### White desk NS 0257

- a small functional desk with three spacious drawers, ideal for small rooms. Fresh, modern colour scheme. Chipboard framework, MDF drawer fronts in yellow, orange, blue.
- desk 120 cm x 75 cm x 76 cm;
- lower drawer 32 cm x 42 cm x 16 cm;
- higher drawer 32 cm x 42 cm x 29 cm.



### Cubo desk NC 7001

- a complementary item to the series. Its colour and construction will make it useful in any interior. Made of high-quality laminated board, it has two practical drawers and a lockable slot with a shelf. The framework is made of birch laminate.
- 115 x 48 x 77,5 cm



### Drawers

NC 001□Z  
□ 37 x 37 x 18 cm, 2 pcs.  
□ with lock

### Door

NC 007□Z  
□ 37 x 37 cm  
□ with lock



drawers and doors available in 5 colours (4 for green, 2 for grey, etc.)



Teacher's desk



Birch - green  
NS 2506



Birch - orange  
NS 2503



Beech - white  
NS 2500



Beech  
NS 2522

Teacher's desk  
with door and 1 drawer



Birch - green  
NS 2507



Birch - orange  
NS 2504



Beech - white  
NS 2501



Beech  
NS 2520

Teacher's desk  
with door and 2 drawers



Birch - green  
NS 2508



Birch - orange  
NS 2505



Beech - white  
NS 2502



Beech  
NS 2521

# prof desk

beech

beech – white

birch – green

birch – orange

A teacher's desk made of laminated chipboard (beech or birch effect) with coloured fronts. Many colour configurations available. Will match most of our furniture series. Left or right hand option Installation possible for the cabinet and drawers. The locks restrict unauthorized

- access to documents.
- 120 x 60 x 77 cm



Snakes with ladders

HK 0001

- 2 x 3 m

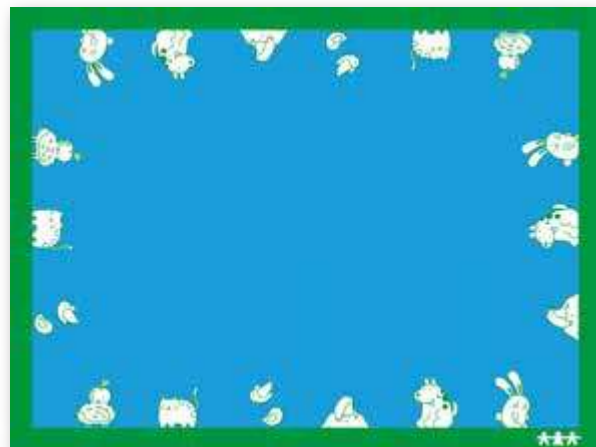

Carpet Minty

HK 0009

- 3 x 4 m

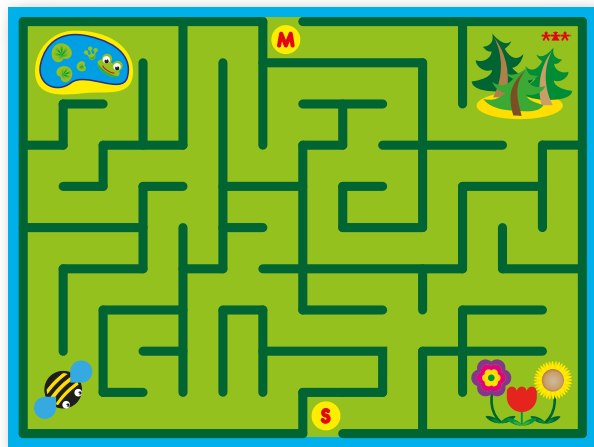

Labyrinth

HK 0005

- 3 x 4 m

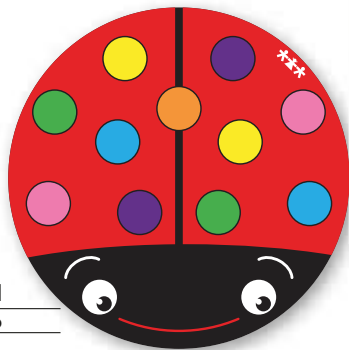

Ladybird

HK 0006

- ø 2 m

## carpets



Jungle

DL 0500

- 4 x 5 m
- heat set frise carpet

A carpet made from a double frise polypropylene yarn. These carpets are soft, antiallergic, anti-static, fade and wear resistant, easy to clean and with a non-slip bottom.

# mirrors

mirror decorations to be fixed on the wall



**Cloud**

**NS 1664**

- 59 x 43 cm



**Sun**

**NS 1663**

- 40 x 40 cm



**Flowers**

**NS 1665**

- ø flower 40 cm,  
pot 30 x 20 cm,  
4 pcs.



**Mirror 1**

**NS 3064**

- 60 x 120 cm



**Fish**

**NS3065**

- fish 20 x 21,5 cm
- foil 60 x 27 cm

**mirror decorative elements**

Colour laser-printed fairy-tale-theme decorative element made of from plywood. Sold without mirror.



**Menu tapestry**

**NS 1604**

- 83 x 50 cm



**Tool set**

**NS 9000**

- 19 pcs.



**Furniture anchor**

**TBZ 0001**

Used for securing taller furniture to the wall.

- 2 anchors, 6 screws





**White board on wheels - small**  
**YC 9003**

- size: 120 x 90 cm

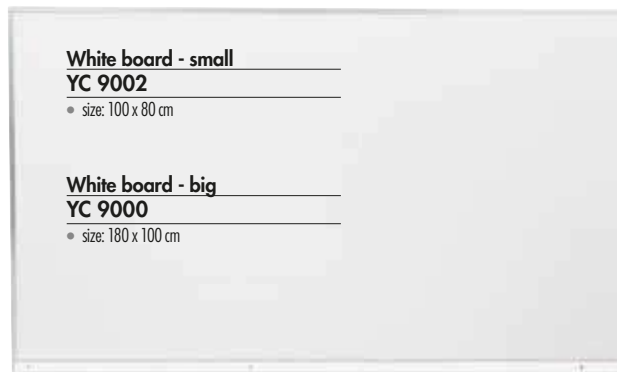

**White board - small**  
**YC 9002**

- size: 100 x 80 cm

**White board - big**  
**YC 9000**

- size: 180 x 100 cm

## boards

**Advertising board with paper**  
**YC 9005**

- size: 100 x 70 cm



**White board on wheels**  
**YC 9001**

- size: 180 x 100 cm



# showcases



Showcase moving doors, fabric inside

YC 9006

- size: 200 x 107 cm



Showcase with door, cork inside

YC 9007

- size: 150 x 103 cm



Showcase with door, magnetic inside

YC9004

- size: 100 x 70 cm

# pin boards



- green  
NS 2094

- 150 x 100 cm



- orange  
NS 2095

- 120 x 90 cm



- blue  
NS 2093

- 200 x 100 cm

preschool, with engraving

**Tea spoon**

**NS 9095**

- 13,5 cm



**Spoon**

**NS 9155**

- 18,5 cm



**Fork**

**NS 9135**

- 17,2 cm



**Knife**

**NS 9145**

- 19,0 cm



school

**Tea spoon**

**NS 9096**

- 13,5 cm



**Spoon**

**NS 9156**

- 20,4 cm



**Fork**

**NS 9136**

- 20,7 cm



**Knife**

**NS 9146**

- 22,9 cm



**Nowa Szkoła Wall Clock**

**NS 2008**

- ø 30 cm, 1 AA battery (not provided)



**Blue baby bib**

**NS 2649**

- 19,5 x 30 cm
- collar 25cm
- snap fastener



**Pink baby bib**

**NS 2650**

- 19,5 x 30 cm
- collar 25cm
- snap fastener







x5

Melamine dish set  
for 5 children

- mug
- shallow plate
- deep plate
- dessert plate
- fork
- knife
- spoon









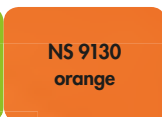
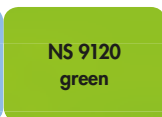
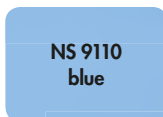



















35  
pcs.



## melamine dishes

Melamine dishes in beautiful colors are light and safe for children. Durable, resistant and unbreakable. Can be washed in a dishwasher at 70° C



		blue	green	orange	yellow
Mug	ø 7,5 x 10 cm	NS 9101 	NS 9102 	NS 9103 	NS 9104 
Shallow plate	ø 19,8 x 2,7 cm	NS 9111 	NS 9112 	NS 9113 	NS 9114 
Dessert plate	ø 15 x 2 cm	NS 9191 	NS 9192 	NS 9193 	NS 9194 
Deep plate	ø 16,3 x 4,8 cm	NS 9121 	NS 9122 	NS 9123 	NS 9124 
Fork	13,7 x 2,5 x 1,3 cm	NS 9131 	NS 9132 	NS 9133 	NS 9134 
Knife	13,5 x 0,9 cm	NS 9141 	NS 9142 	NS 9143 	NS 9144 
Spoon	13,6 x 3 x 1,8 cm	NS 9151 	NS 9152 	NS 9153 	NS 9154 





**Art cabinet on wheels**  
**NS 0781**

• size: 80 x 75 x 40 cm; sold without accessories



**Mobile activity table**  
**NS 0594**

• size: 62.5 x 42 x 67 cm; sold without accessories

# Art cabinets

Colourful and functional cupboards are a convenient way of organizing and storing all kinds of art materials. The variety of drawers, containers and cabinets guarantees efficient use of space. Besides, they are easy to use and they help reduce the load in schoolchildren's backpacks. Storage units on castors help move and organize classroom tools and materials according to current needs.



**Cubo**  
**NC 4000**

- A double-sided mobile cabinet from the Cubo series for art materials. The cabinet has 3 tiers and 4 types of shelves:
- a large open shelf 77 x 38 x 10 cm
- a small open shelf 36 x 38 x 10 cm
- 9 shelves with colour dividers, 36 x 17 x 36 cm
- 2 cabinet shelves 36 x 35 x 36 cm;
- whole unit 114 x 39 x 87 cm
- framework: laminated particle board in birch colour
- dividers: laminated particle board in turquoise, key lime or grey colour
- 5 castors (including 2 with a lock facility)



two-sided



**Universal**  
**NS 0782**

A mobile cabinet for storing and keeping in order various art materials on shelves or in all-purpose trays.

- storage space for large-size cardboard
- a small open shelf
- a large open shelf
- 2 large cabinet shelves
- 4 green plastic trays (1 deep, 3 shallow)
- 2 long bins for paint bottles
- dimensions of the cabinet without bins: 98 x 45 x 76 cm
- dimensions of the cabinet with bins: 98 x 58 x 76 cm
- framework: laminated particle board in birch colour
- fronts: MDF board in green colour; milled
- 4 castors (including 2 with a lock facility)



two-sided



# dryers



**Wall drying rack. Red**  
**MT 5460**

Wall drying rack for drying children's paintings;  
• 20 levels;  
• dimensions: 50 x 40 x 62 cm



**Large-sized**  
**MT 5457**

• 25 levels; size: 43 x 33 x 90 cm



**Small-sized**  
**MT 5455**

• 17 levels; size: 43 x 33 x 65 cm

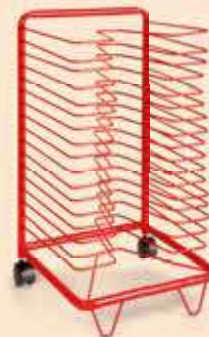

Light practical stands are ideal for storing and presenting maps and wall charts, especially in schools and colleges. They help organize space functionally and economically. Wall racks help store in order maps and charts in large numbers and in perfect order.

The stands are made of metal rods and profiles and fixed to a base with legs or on castors.

# map hangers

You can store more than one map on the hooks.

On the back of each map there are two labels with the name and type of the map. Thanks to this each one can be easily located and identified without the need of unrolling it.



**Wall mounted**  
**ANW 200**

• size of one hanger 8 x 13 x 120 cm



**Map stand**  
**ANW 600**

• h max = 220 cm



**Map rack**  
**ANW 440**

• 100 x 55 x 130 cm





**Multipurpose stand**  
**NS 0578**

Serves as a play corner; with accessories can be used as a puppet theatre (NS 0580).

- glass painting corner (NS 0581) or market stall (NS 0579)
- size: 84 x 51 x 113.5 cm

**Glazed frame**  
**NS 0581**

Used with the multipurpose stand NS 0578 to create an art corner.

**Easel**  
**NS 0445**

¶ size: 164 x 77 cm



**Double easel**  
**NS 1728**

¶ double-sided, foldable, for 2 persons  
¶ (2 trays), H 121 cm, boards 65 x 65 cm



**Four-person easel**  
**NS 1729**

- foldable, double-sided,
- accommodates 4 persons (4 trays); H 121 cm, boards 130 x 65 cm



**Double-sided easel**  
**NS 0309**

- large-sized, double-sided, serves for 6 children; size: 200 x 70 x 95 cm
- sold without trays



**6 trays for**  
**Double-sided easel**  
**NS 0315**

- size: 60 x 12 x 8 cm

**3 trays for Wall easel**  
**NS 0314**

- size: 60 x 12 x 8 cm



**Wall easel**  
**NS 0308**

- size: 198 x 108 x 17 cm
- sold without trays

furniture \* meble \* aménagement \* мебель \* mueble \* mobilia \* möbel \* meubilaire \* أثاث \* 家具 \* softplay \* pianki \* motricité \* игровые лабиринты \* softplay \* softplay \* softplay \* foam speelblokken \* ألعاب اسفنجية \* 软包 \* education \* edukacja \* éducation \* образование \* educación \* educazione \* bildung \* educatie \* تعليم \* 教育 \* science \* nauka \* sciences \* обучение \* ciencia \* scienza \* wissenschaft \* wetenschap \* علوم \* 科学 \* arts and crafts \* plastyka \* activité manuelle \* пластика \* arte y artesanía \* arte e artigianato \* kunst und handwerk \* knutselmaterialen \* فن وحرف \* 艺术与工艺 \* rehabilitation \* rehabilitacja \* réhabilitation \* реабилитация \* rehabilitación \* reinserimento \* rehabilitation \* revalidatie \* إعادة تأهيل \* 康复 \* therapy \* terapia \* thérapie \* терапия \* terapia \* terapia \* therapie \* therapie \* therapie \* العلاج \* 治疗 \* special needs \* specjalne potrzeby \* pédagogie \* особые потребности \* necesidades especiales \* bisogni speciali \* besondere bedürfnisse \* speciale behoeften \* احتياجات خاصة \* 特殊需要 \* role play \* teatr \* imitation \* театр \* juego de rol \* teatro \* kammerspiele \* rollenspel \* ألعاب دور \* 角色扮演 \* fun \* zabawa \* construction \* развлечение \* divertido \* divertimento \* spaß \* plezier \* تسلية \* 趣味 \* play corners \* kąciki \* coins jeux \* игровые уголки \* jugar esquinas \* giocare agli angoli \* spieelecken \* speelhoeken \* زوايا لعاب \* 玩乐区角 \* physical activity \* aktywność fizyczna \* activité physique \* физическая активность \* actividad física \* attività fisica \* physische aktivität \* lichamelijke oefening \* نشاط بدني \* 体育活动 \* sensory \* sensoryka \* manipulation \* датчиков \* sensorial \* sensoriale \* sensorisch \* sensoriolek \* حسي \* 感统 \* manipulation \* manipulacje \* équipement \* манипуляции \* manipulación \* manipolazione \* manipulation \* ontwikkelingsmateriaal \* تحكم \* 操作 \* indoor \* wyposażenie wnętrz \* musique \* внутреннее оборудование \* interior \* arredamento interno \* innenausrichtung \* interieur inrichting \* داخلي \* 室内 \* music \* muzyka \* jeux et jouets \* музыка \* música \* musica \* musik \* muziekinstrumenten \* موسيقى \* 音乐 \* toys \* zabawki \* игрушки \* juguetes \* giocattoli \* speelzeuge \* educatief speelgoed \* ألعاب \* 玩具



**dirección**

Vía Romana s/n  
E-31520 Cascante  
(Navarra) SPAIN

**teléfono**

+34 948 85 03 84

**fax**

+34 948 85 03 97

**mail**

pedidos@mobeduc.com

**web**

www.mobeduc.com



**European  
Funds**  
Regional Programme



**Republic  
of Poland**



**European Union**  
European Regional  
Development Fund

